

2013 NSA Section 3 Coding Manual

C = Correct

R = Relational Error

D = Distractor Error

O = Other Error

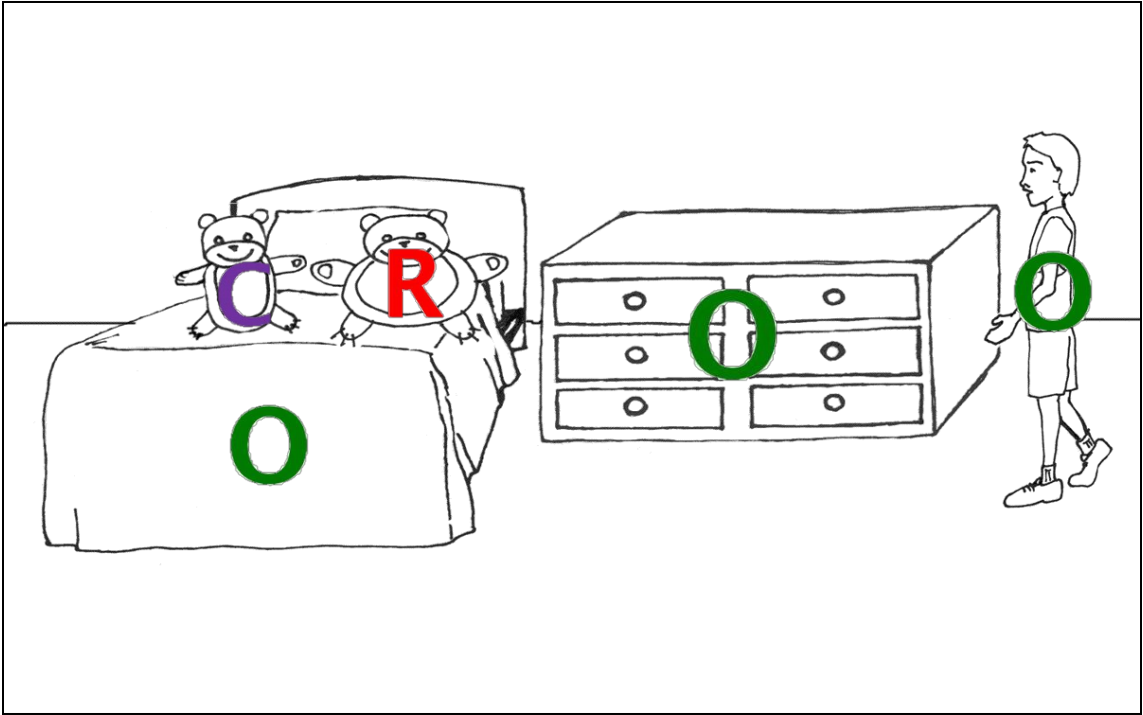
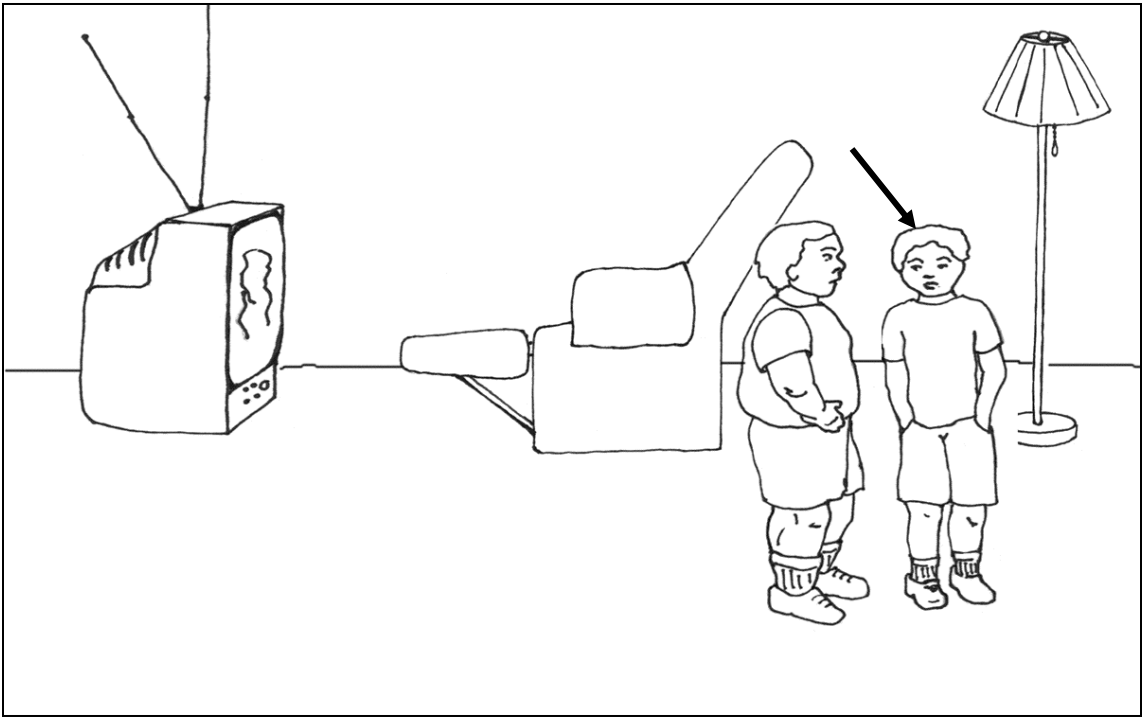

SAMPLE 01

Birthdate _____
Testing Date _____
Identification _____



Sample 02

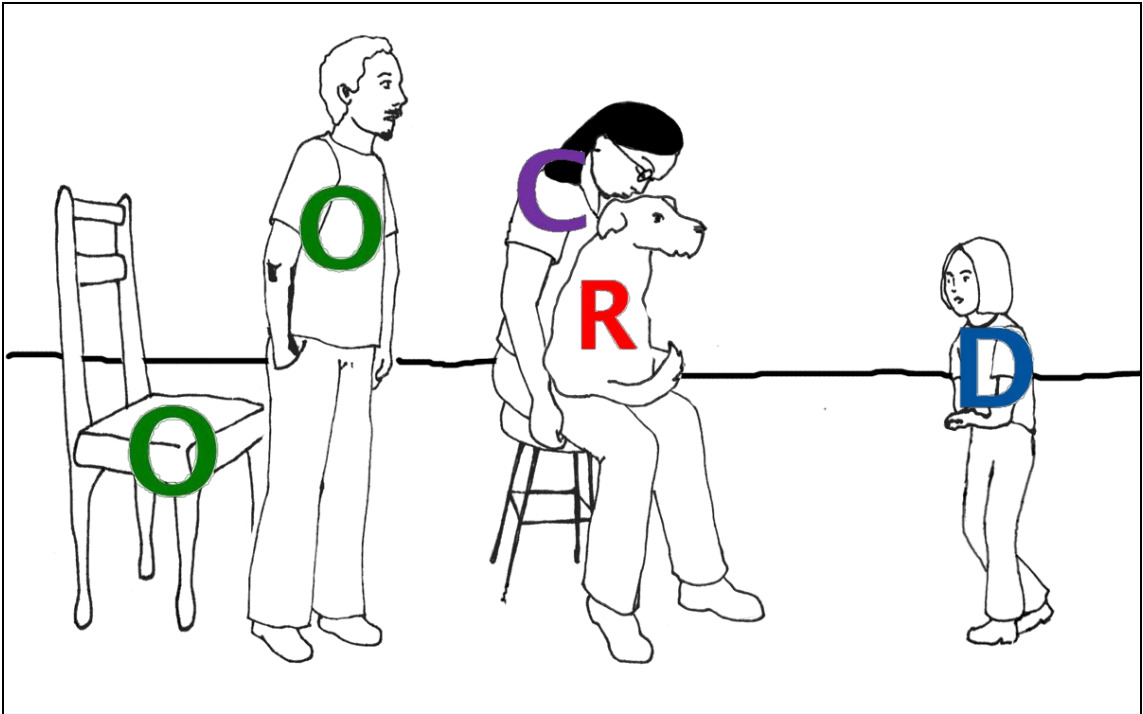
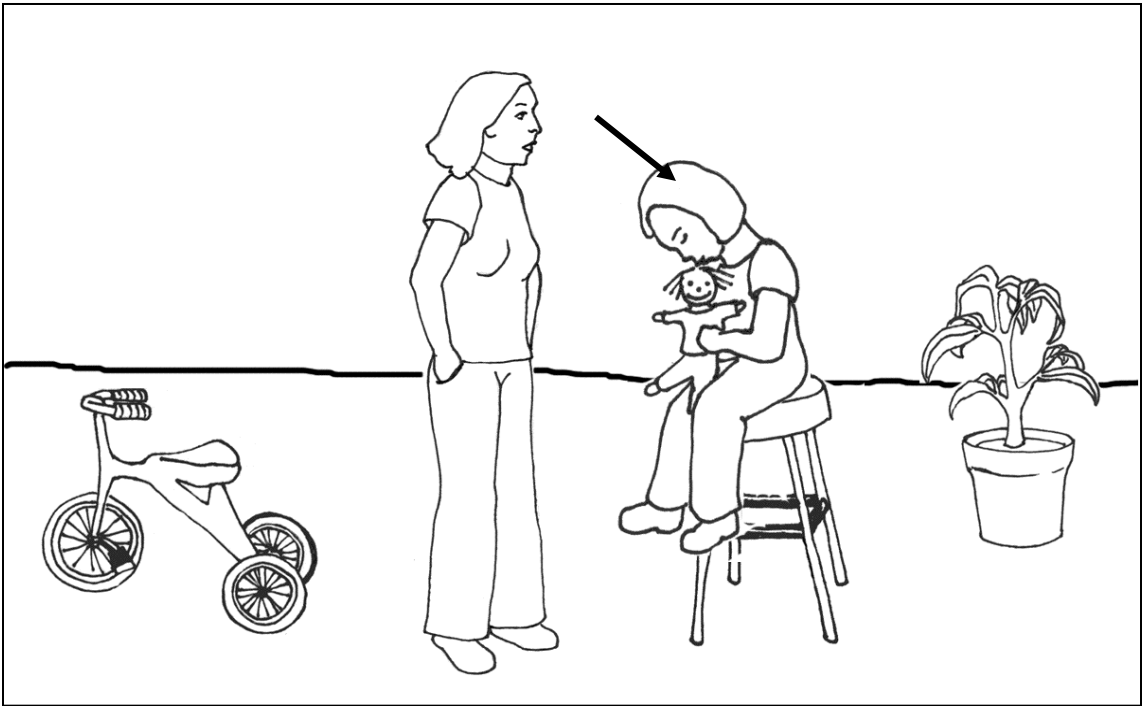

Problem 1-1a

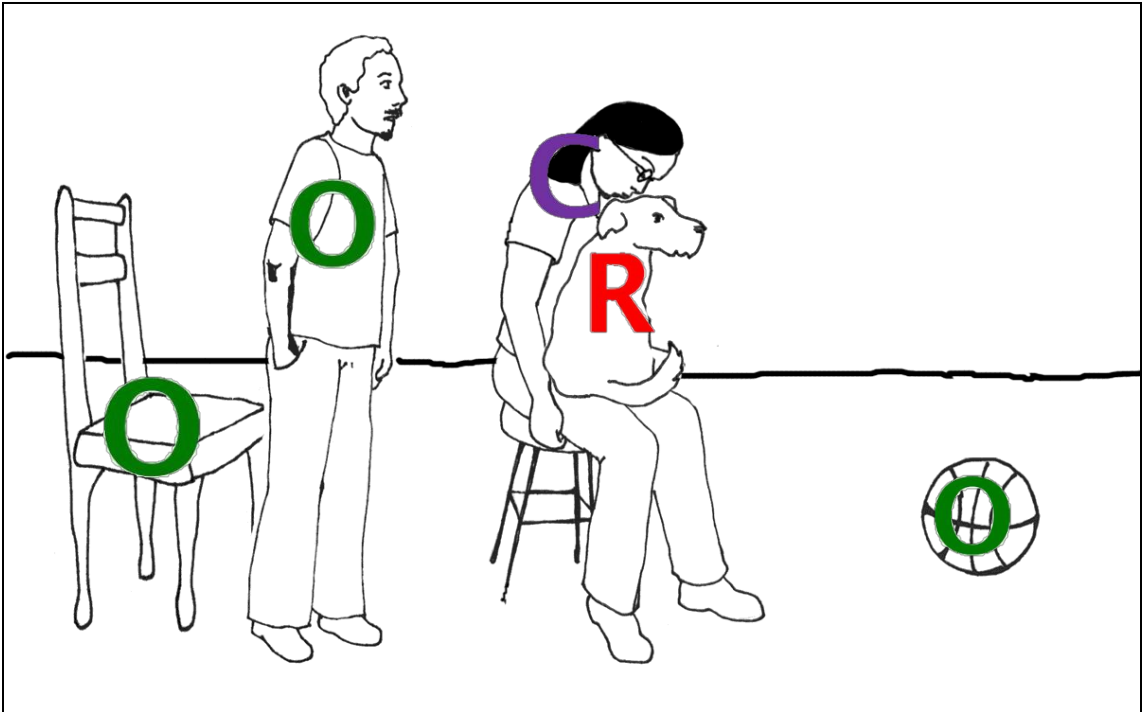
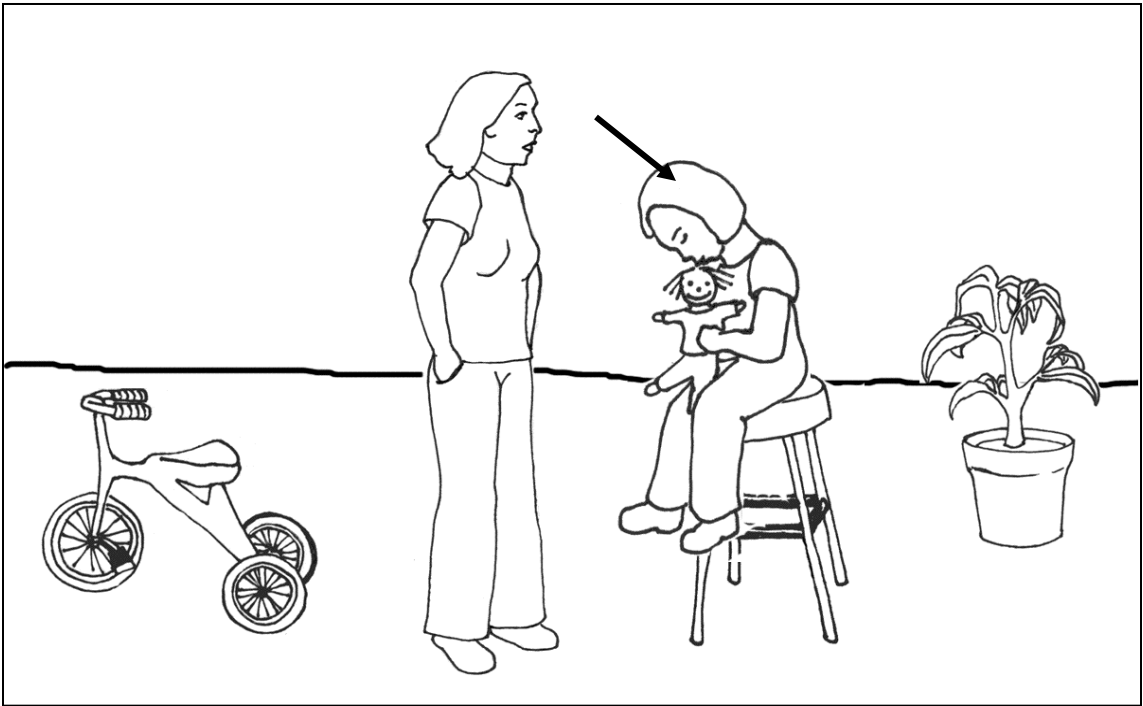

Problem 1-1b

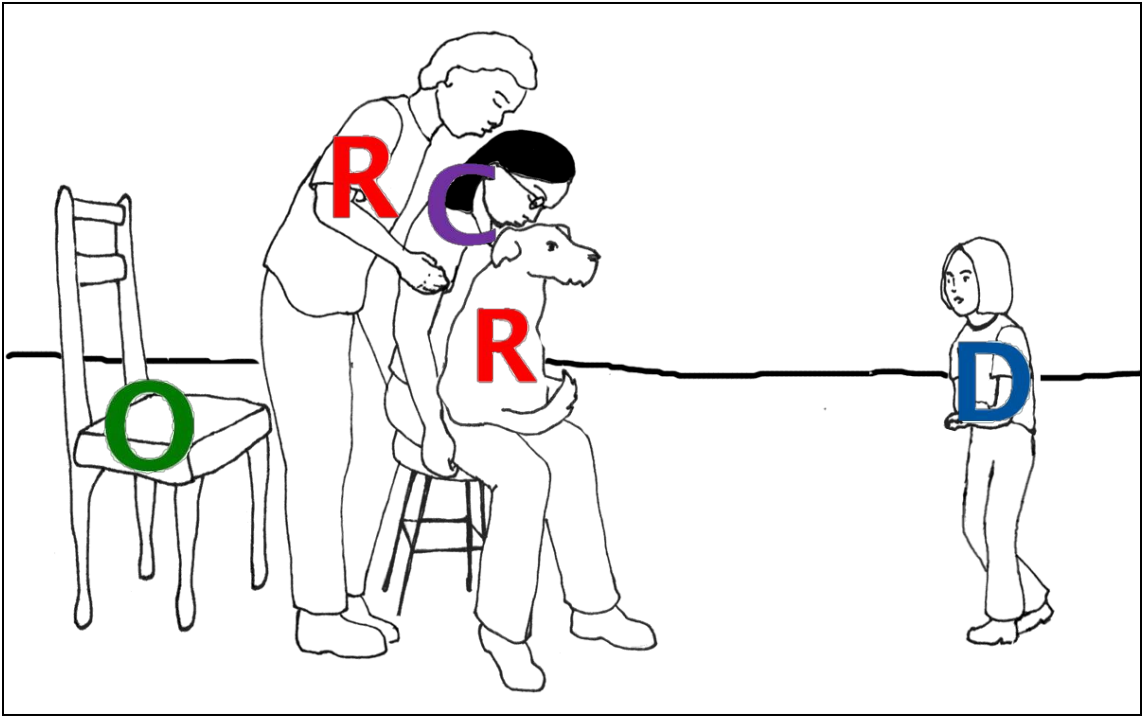
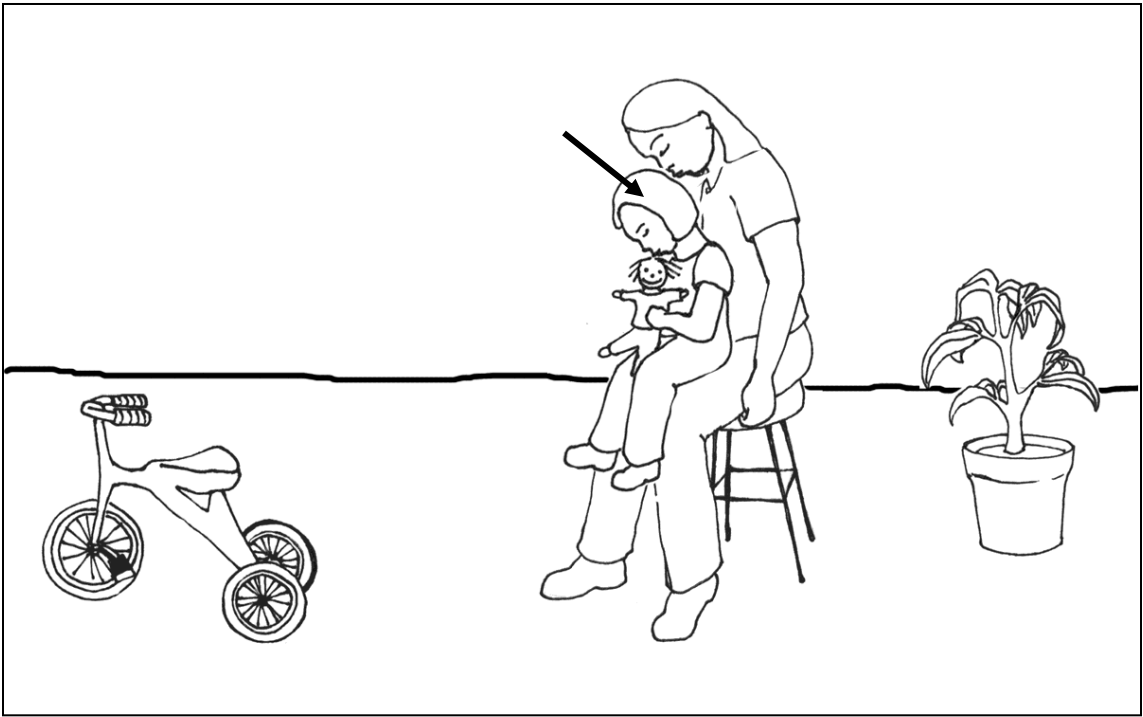

Problem 1-2a

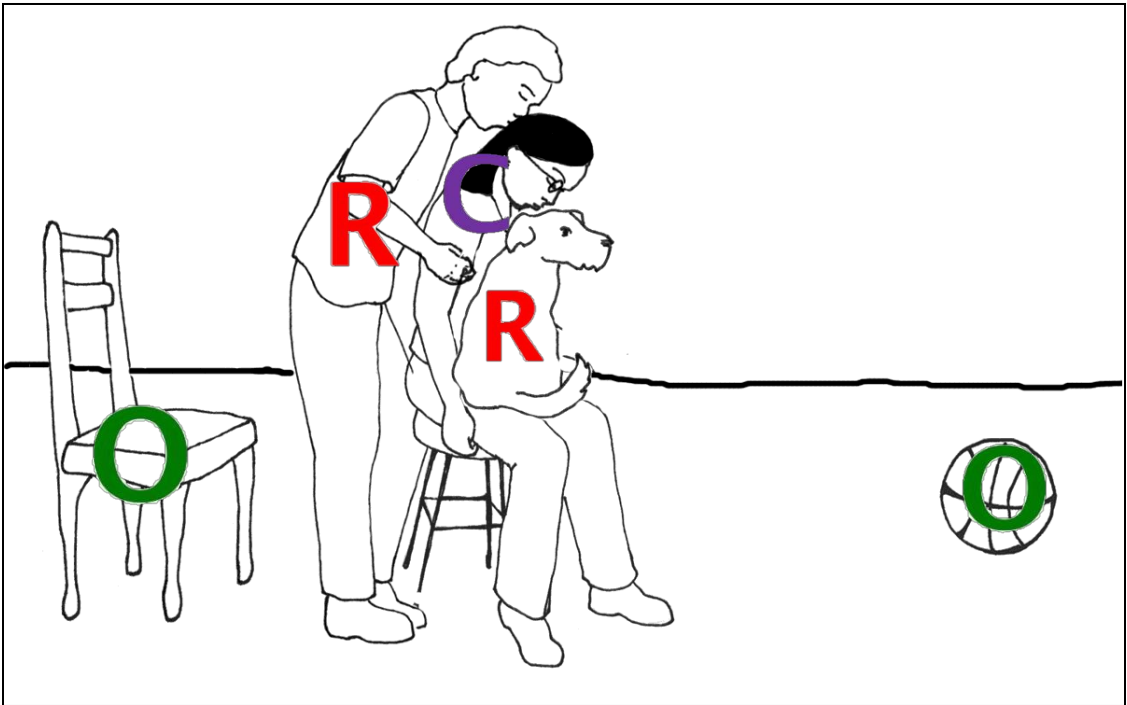
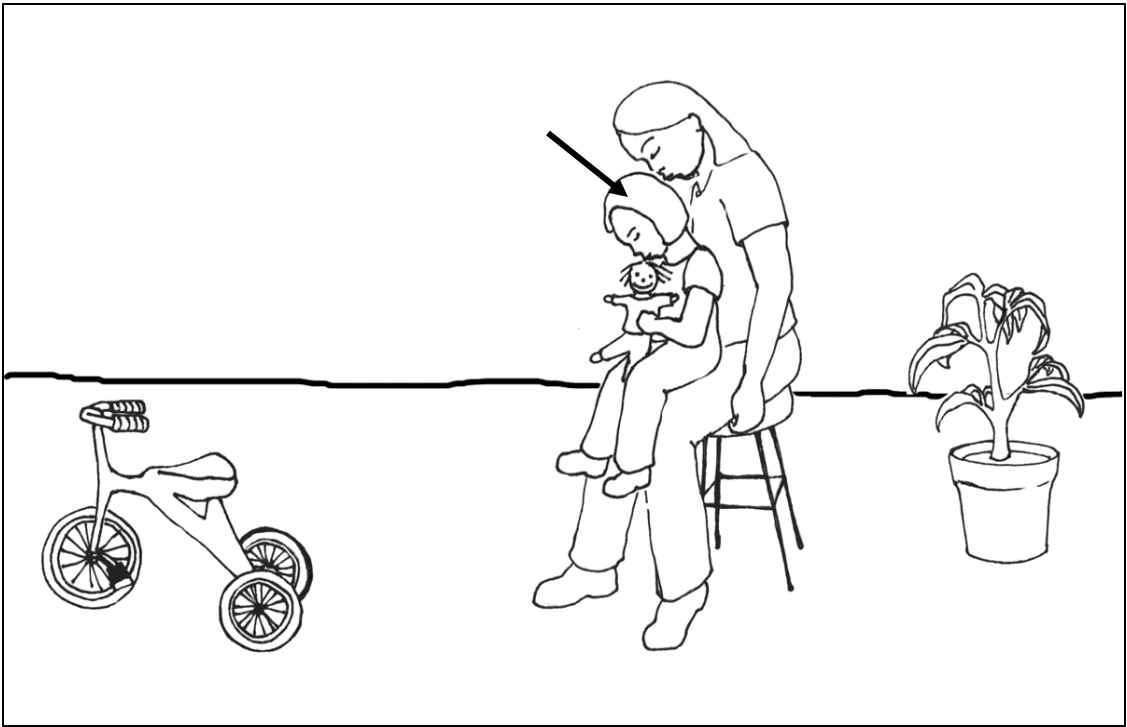

Problem 1-2b

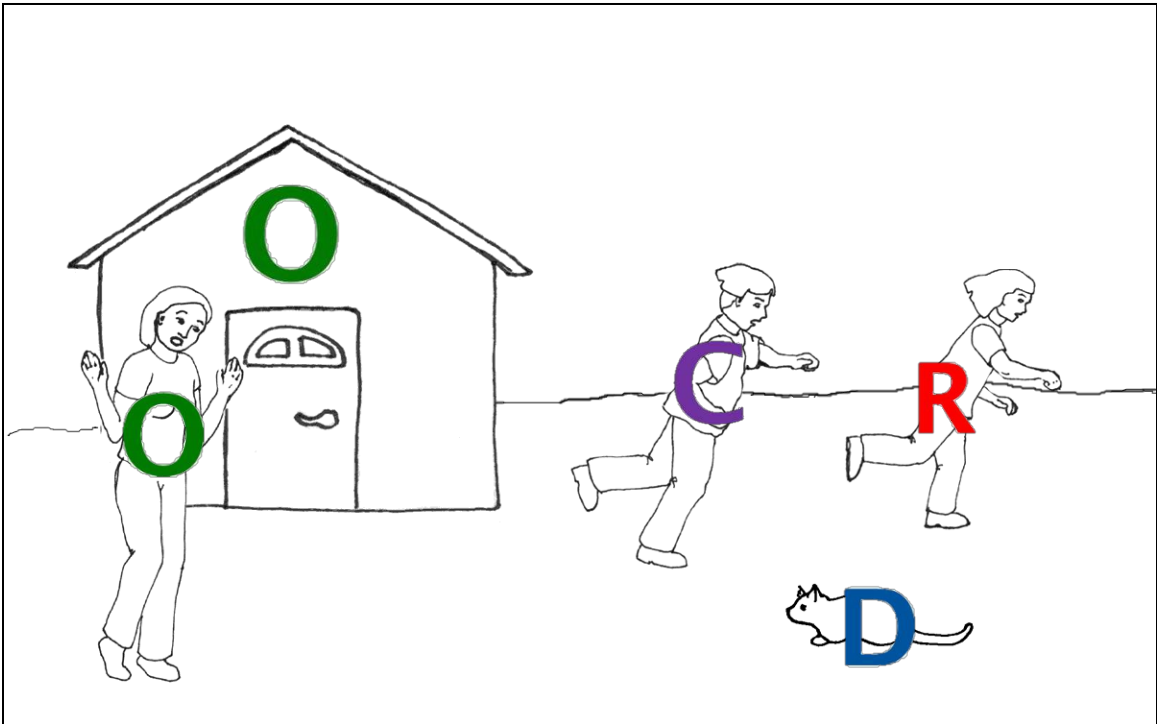
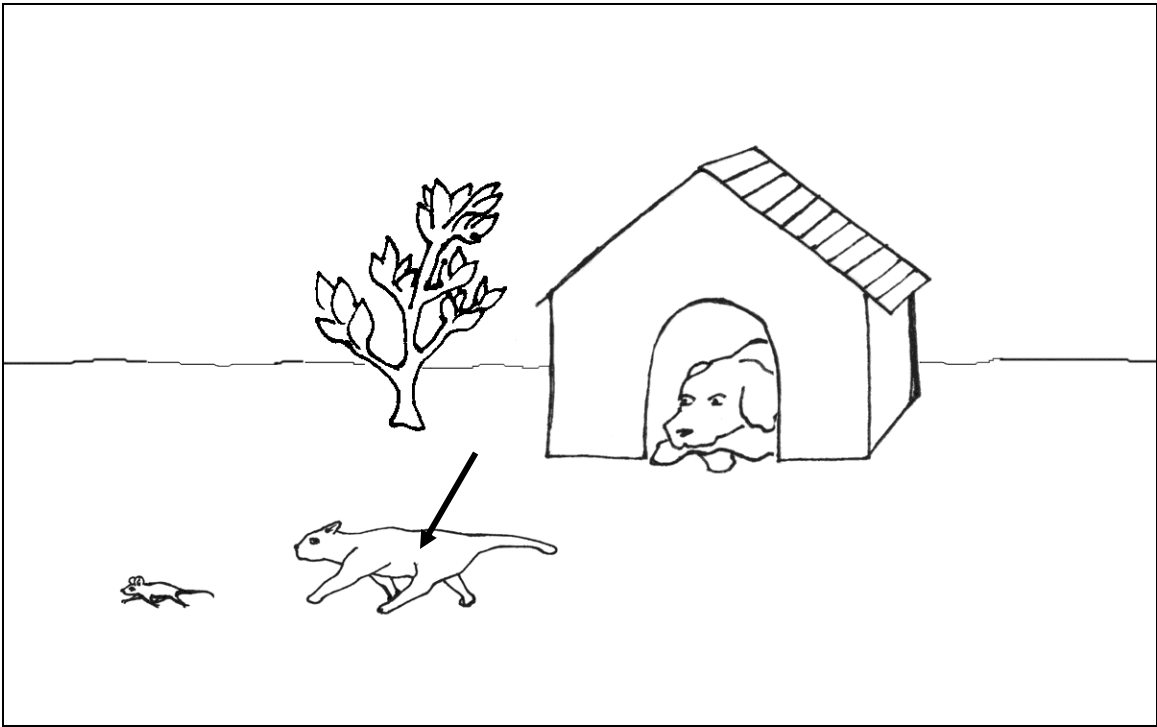

Problem 2-1a

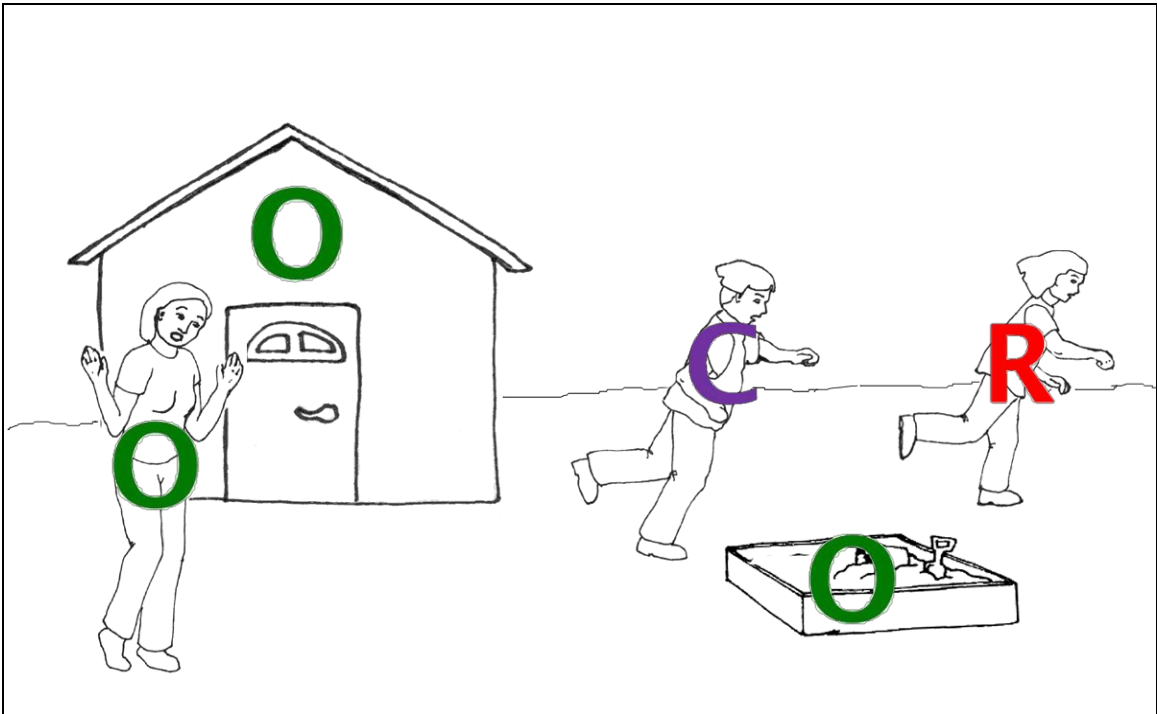
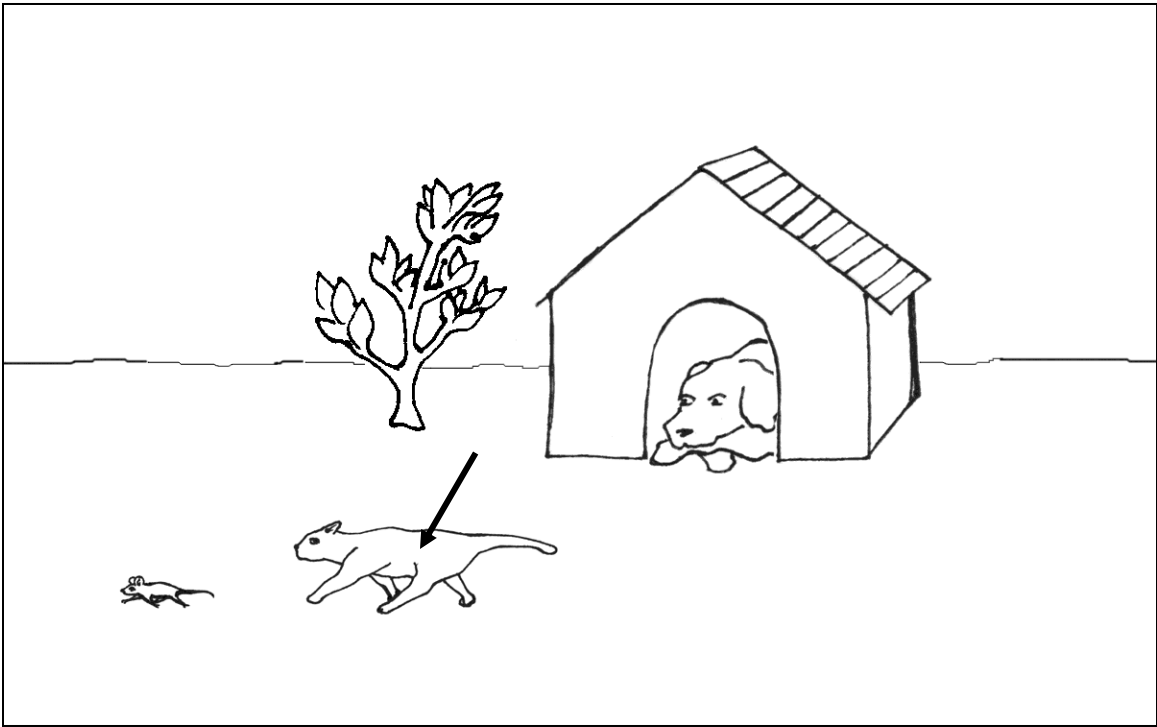

Problem 2-1b

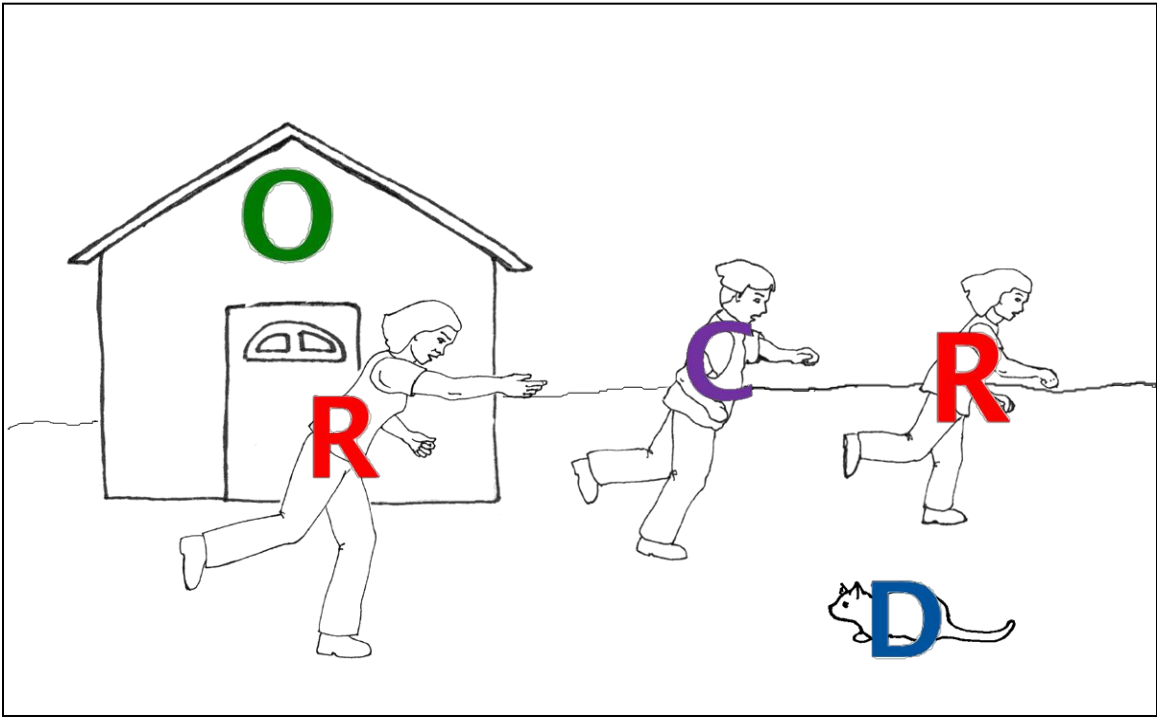
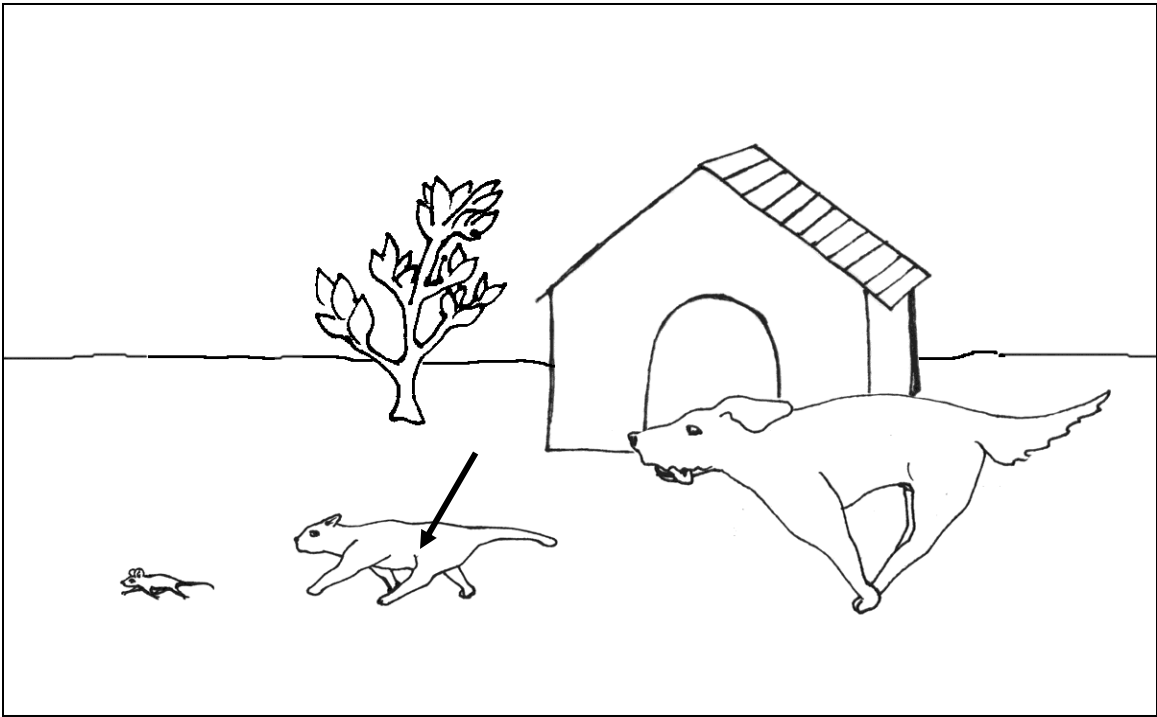

Problem 2-2a

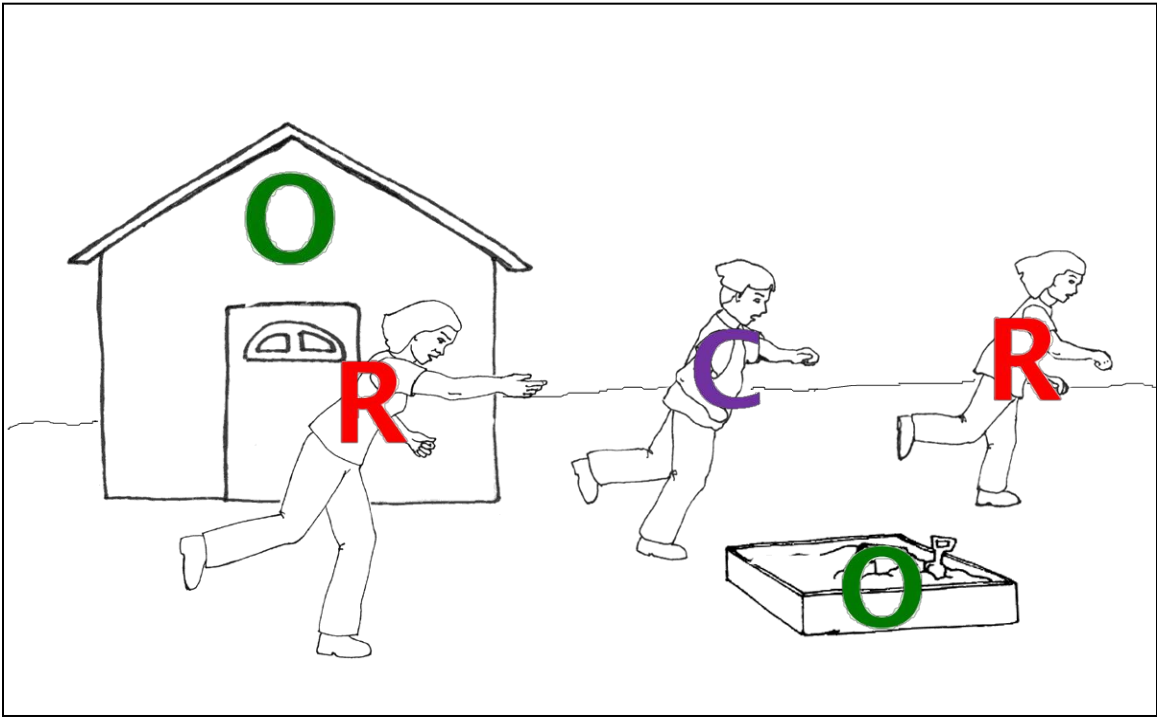
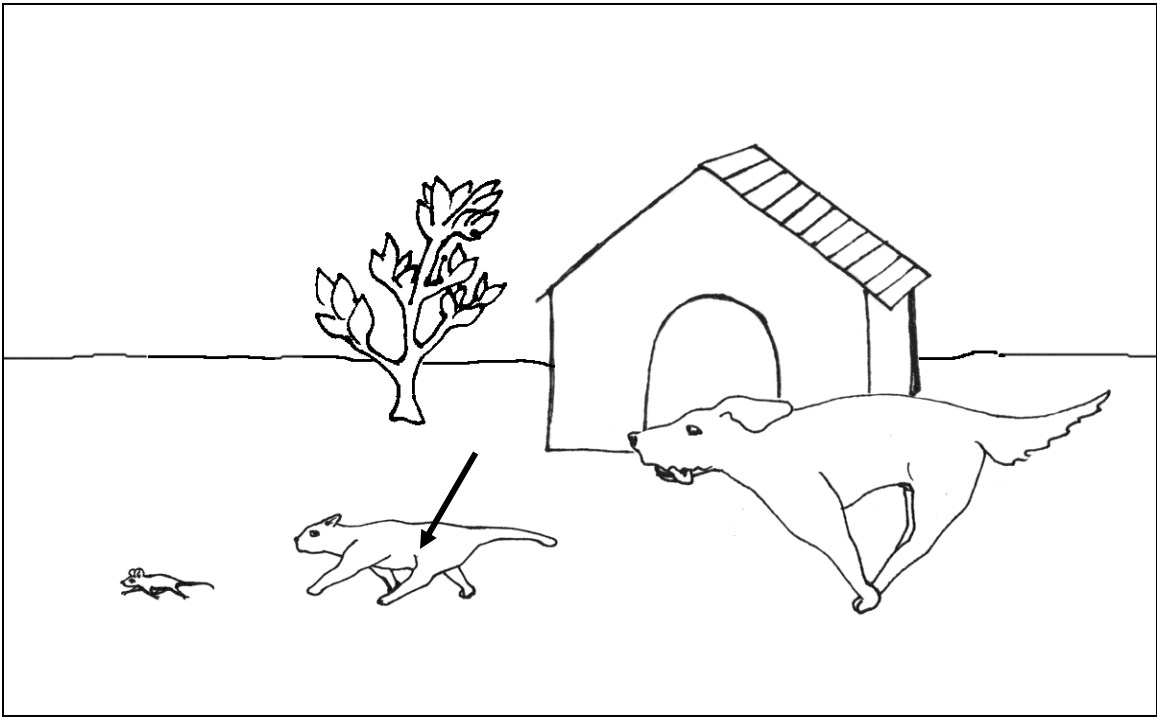

Problem 2-2b

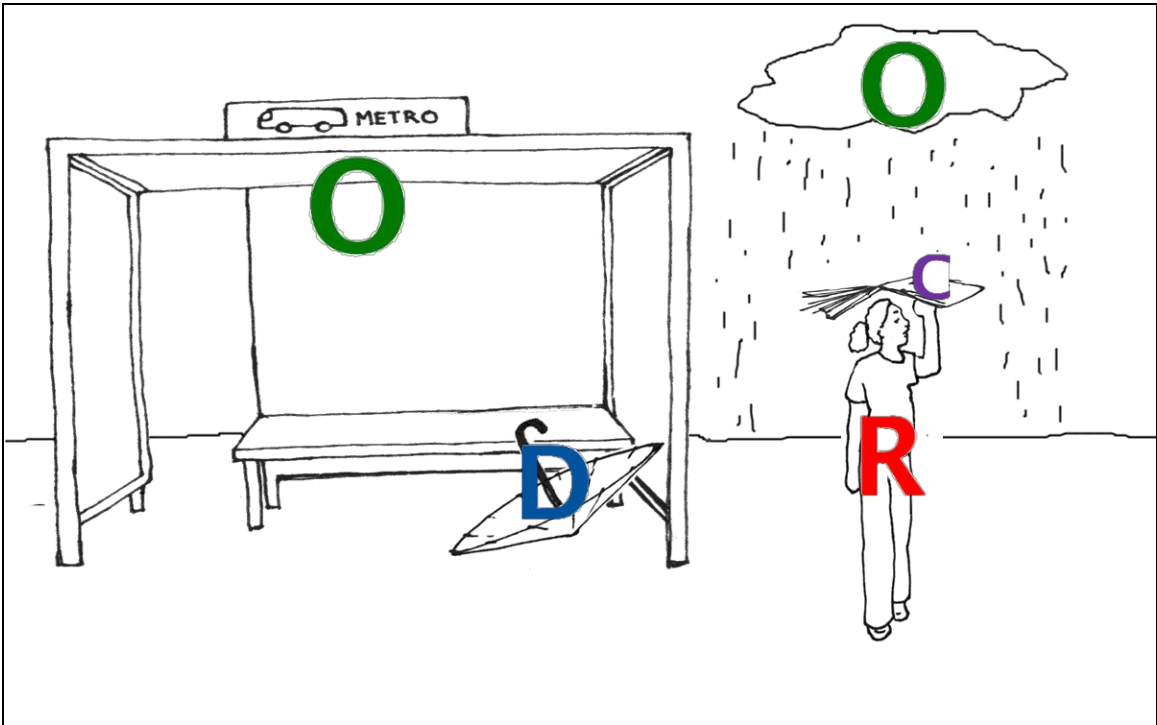
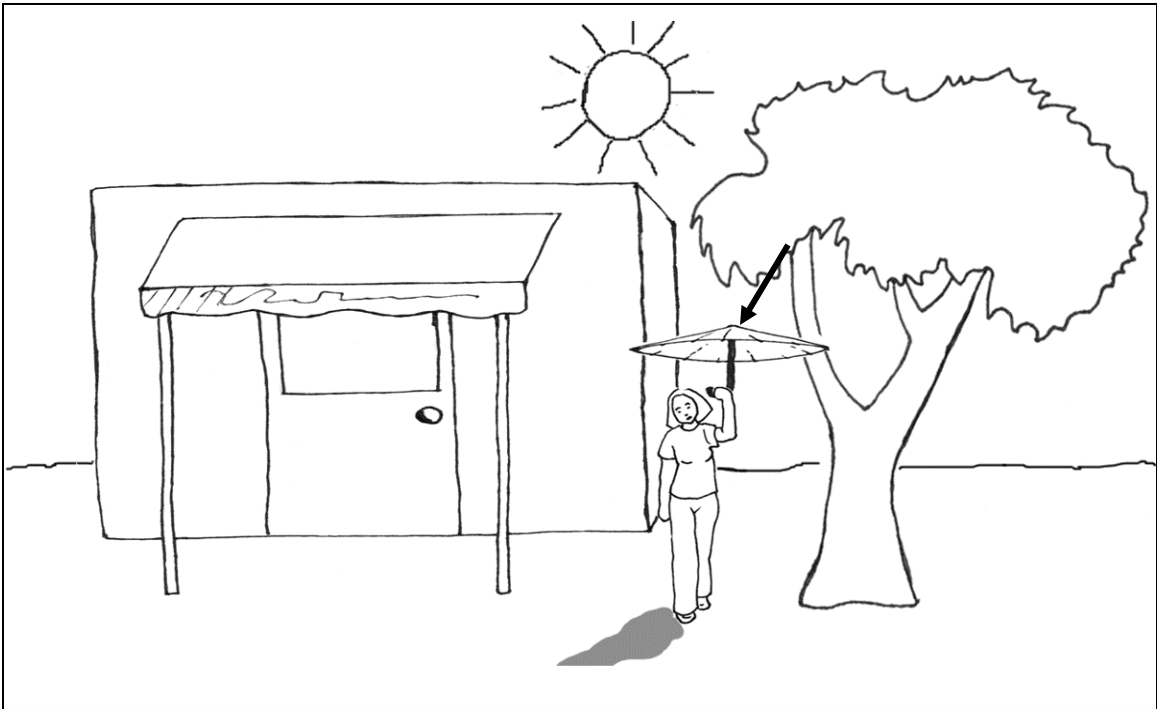

Problem 3-1a

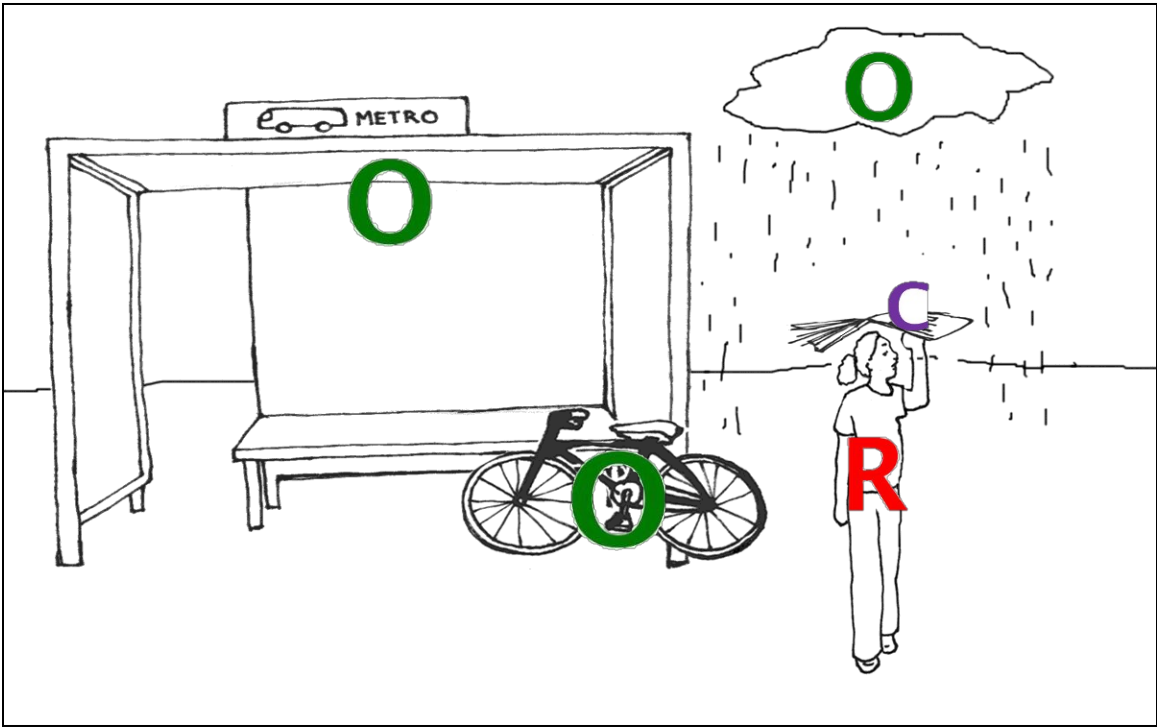
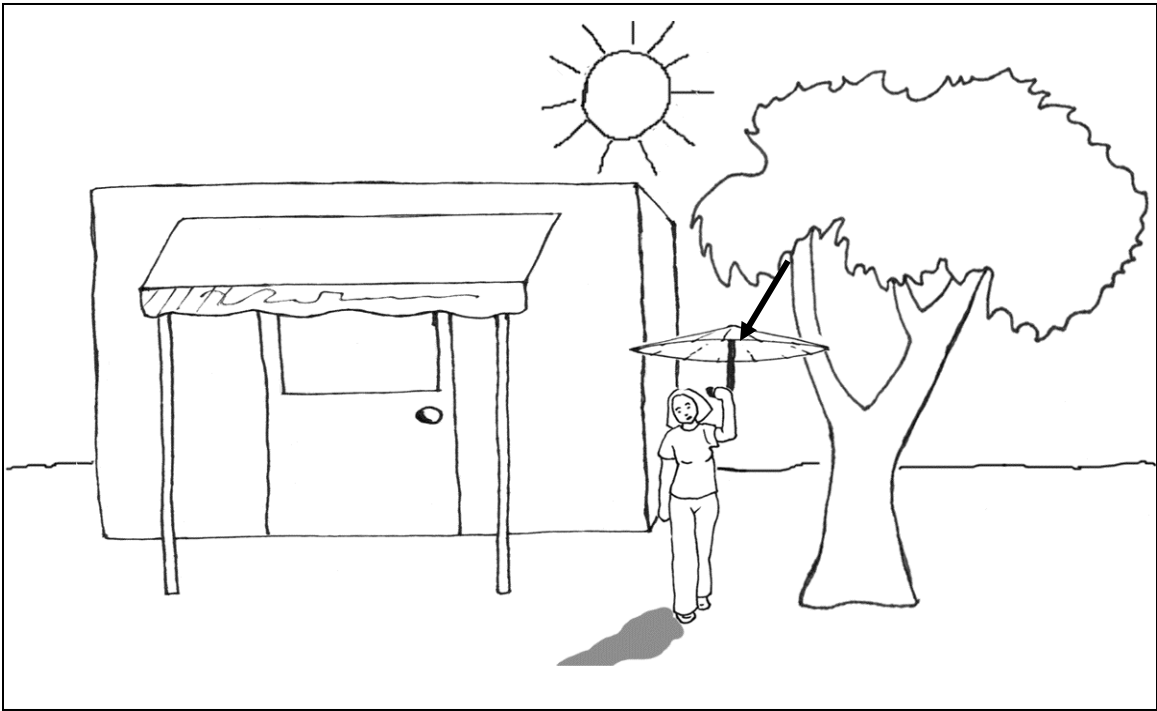

Problem 3-1b

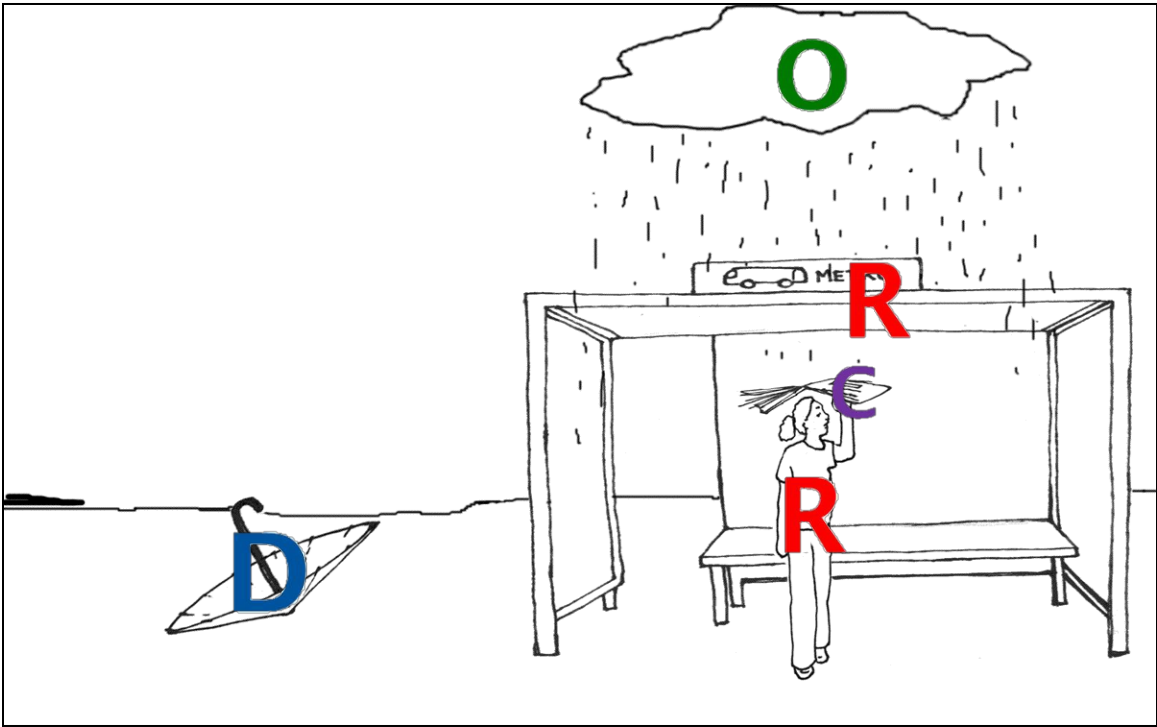
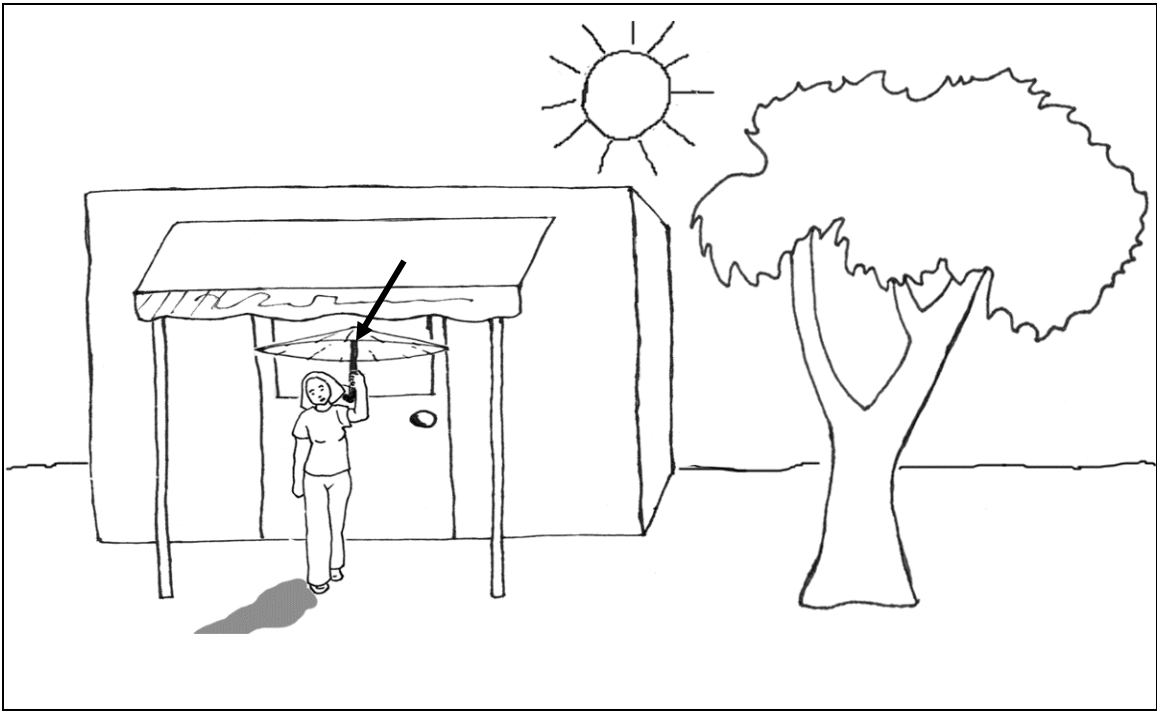

Problem 3-2a

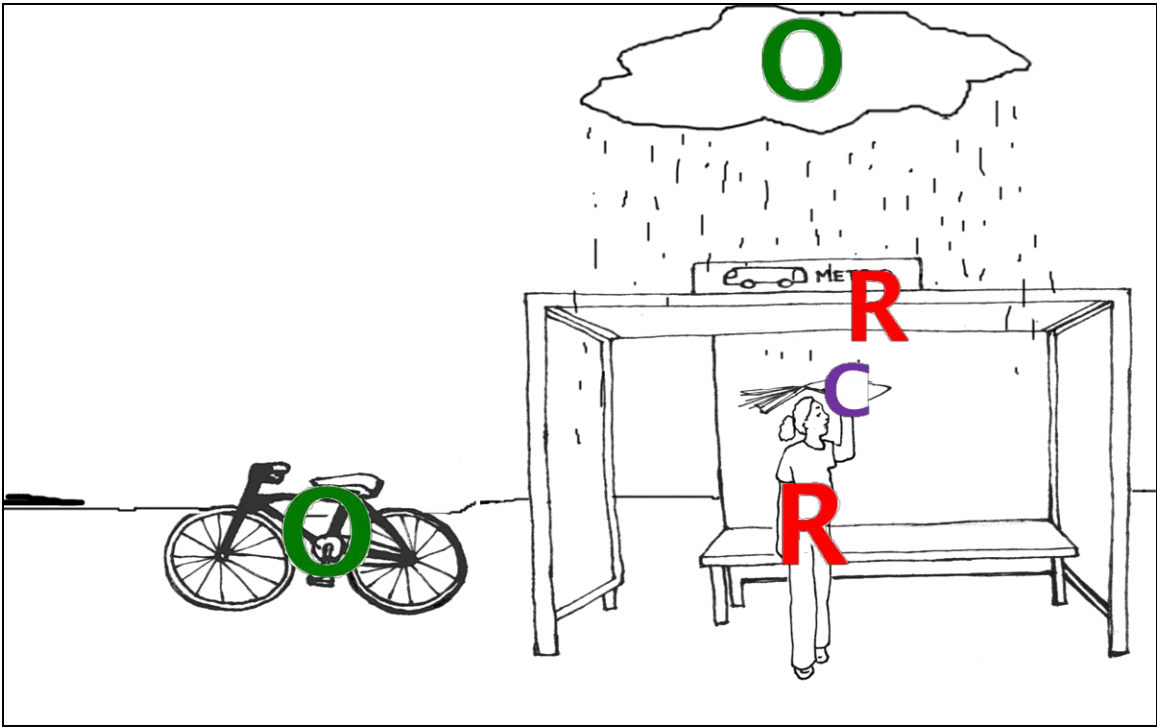
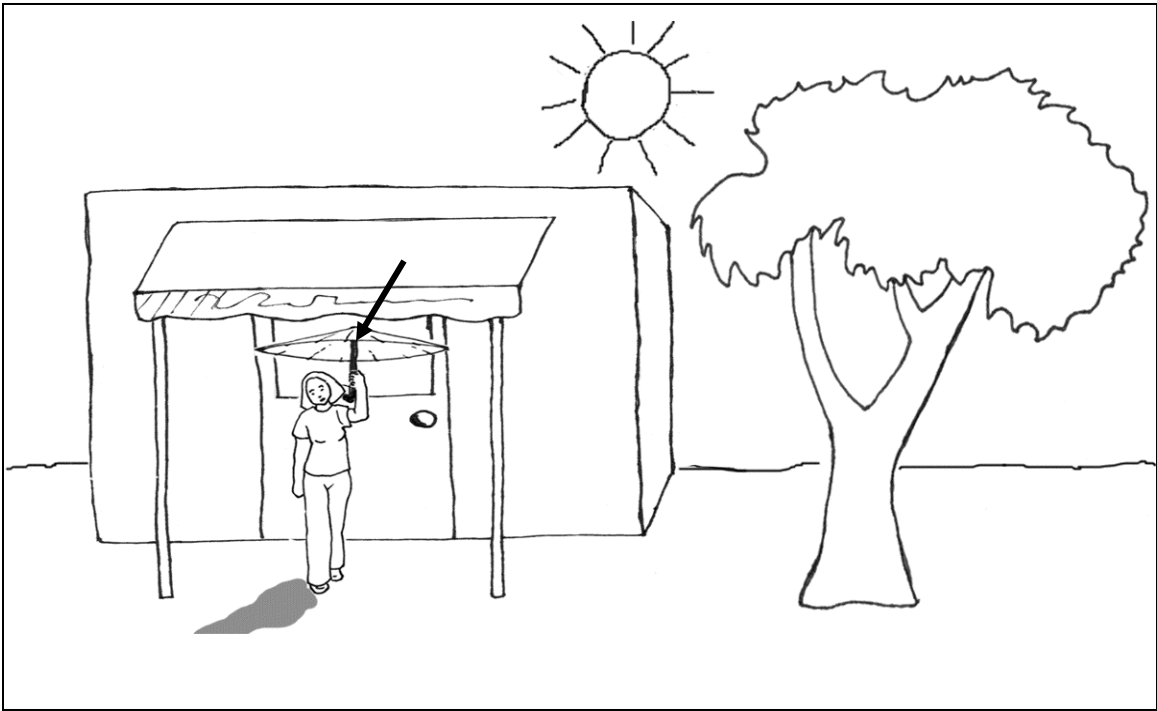

Problem 3-2b

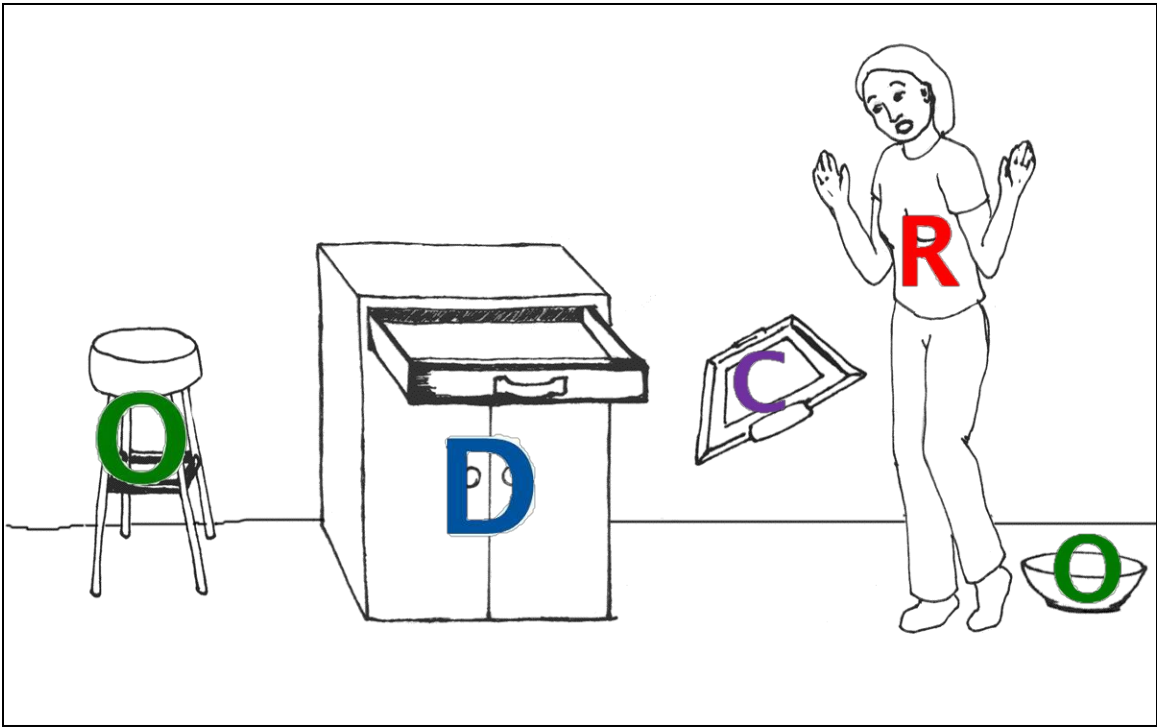
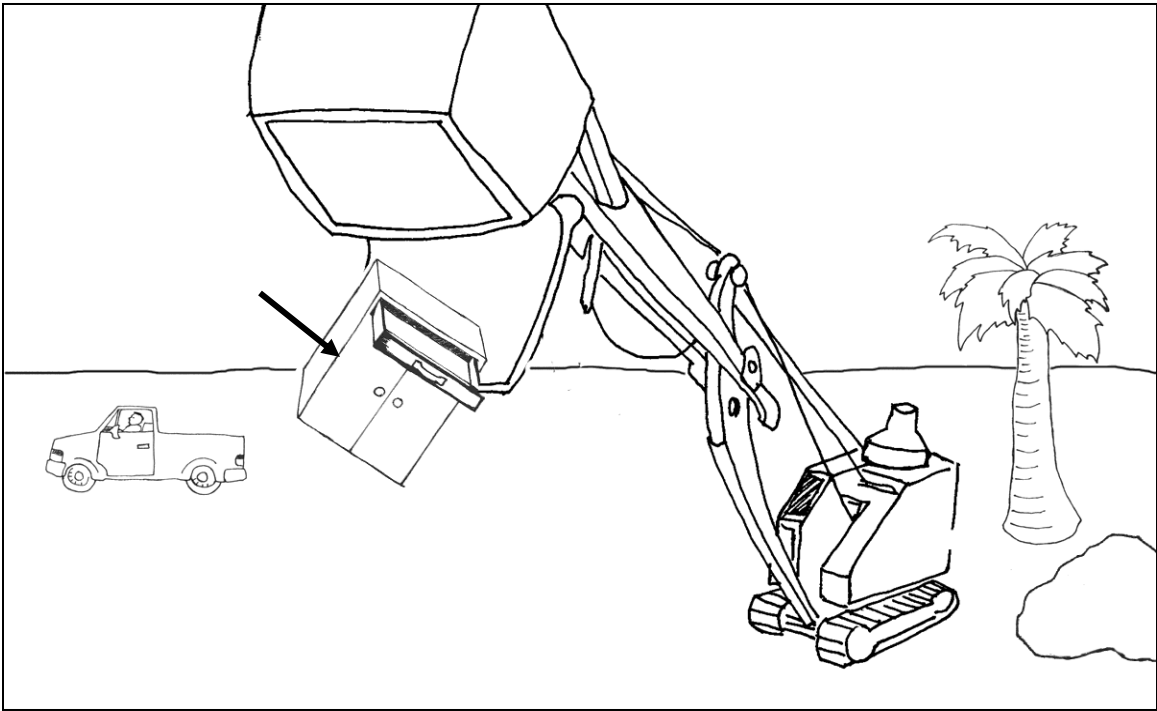

Problem 4-1a

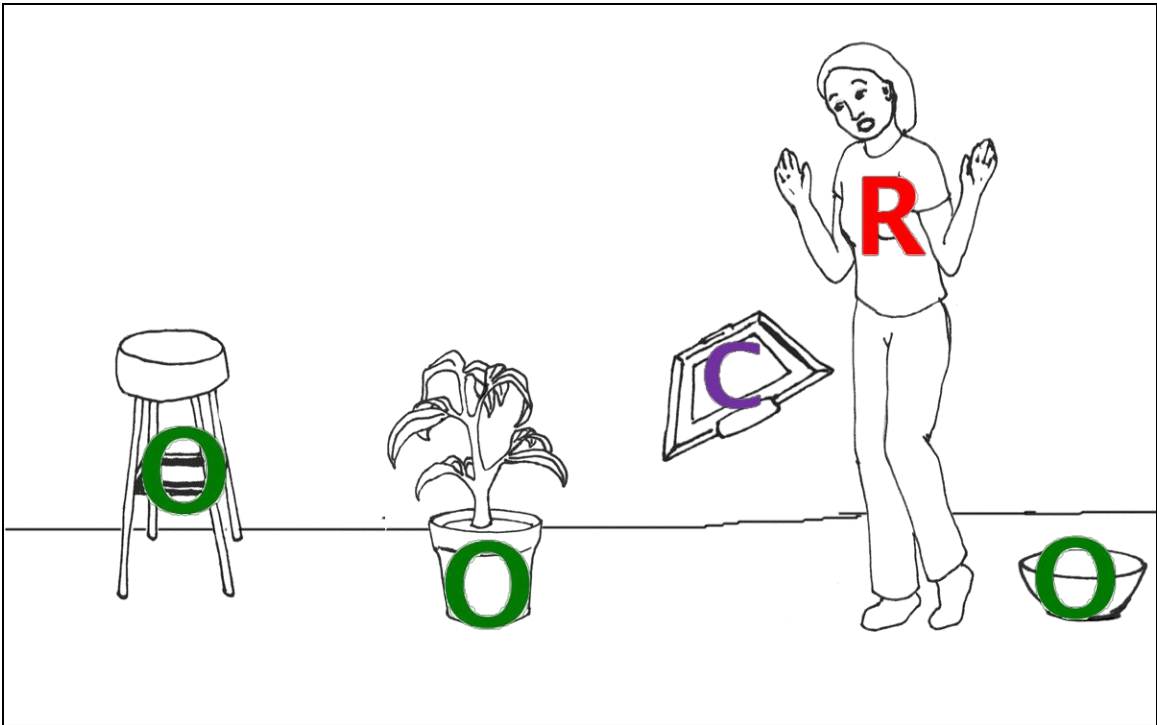
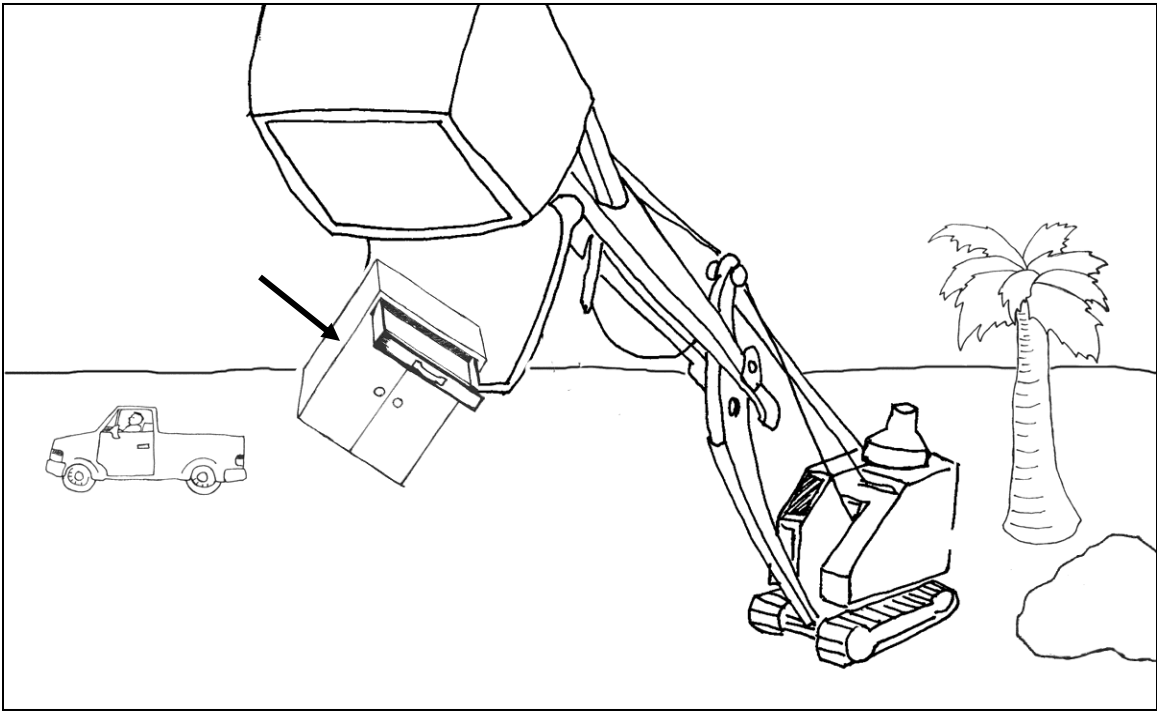

Problem 4-1 b

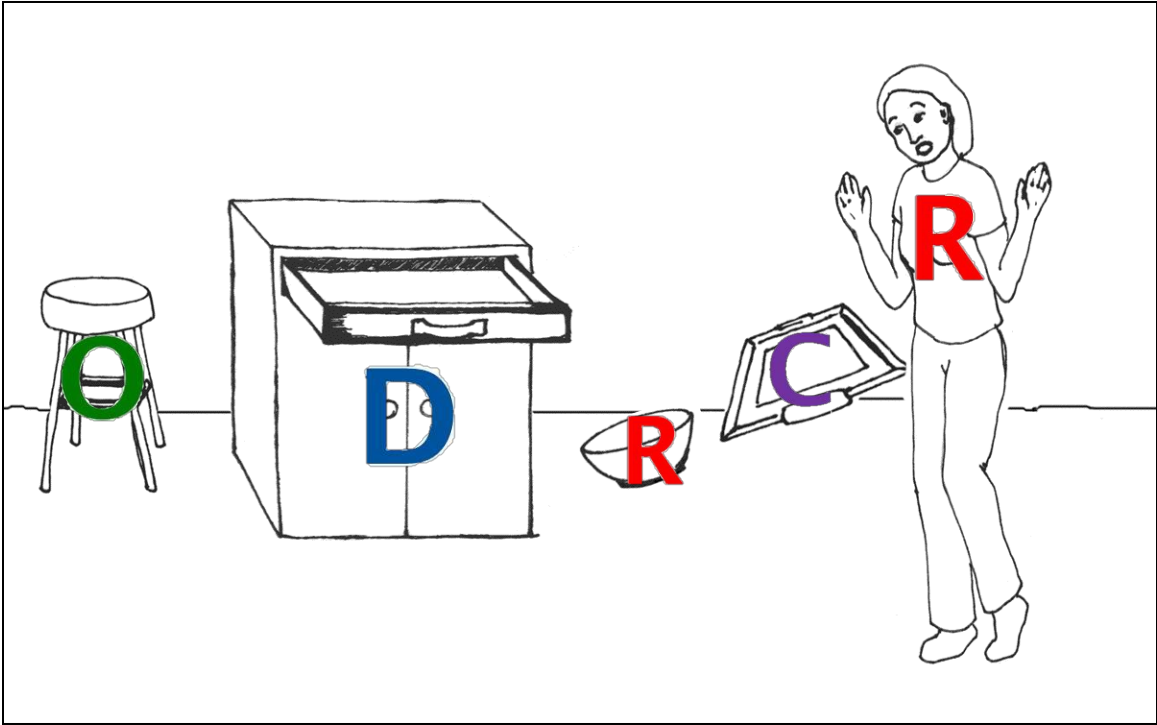
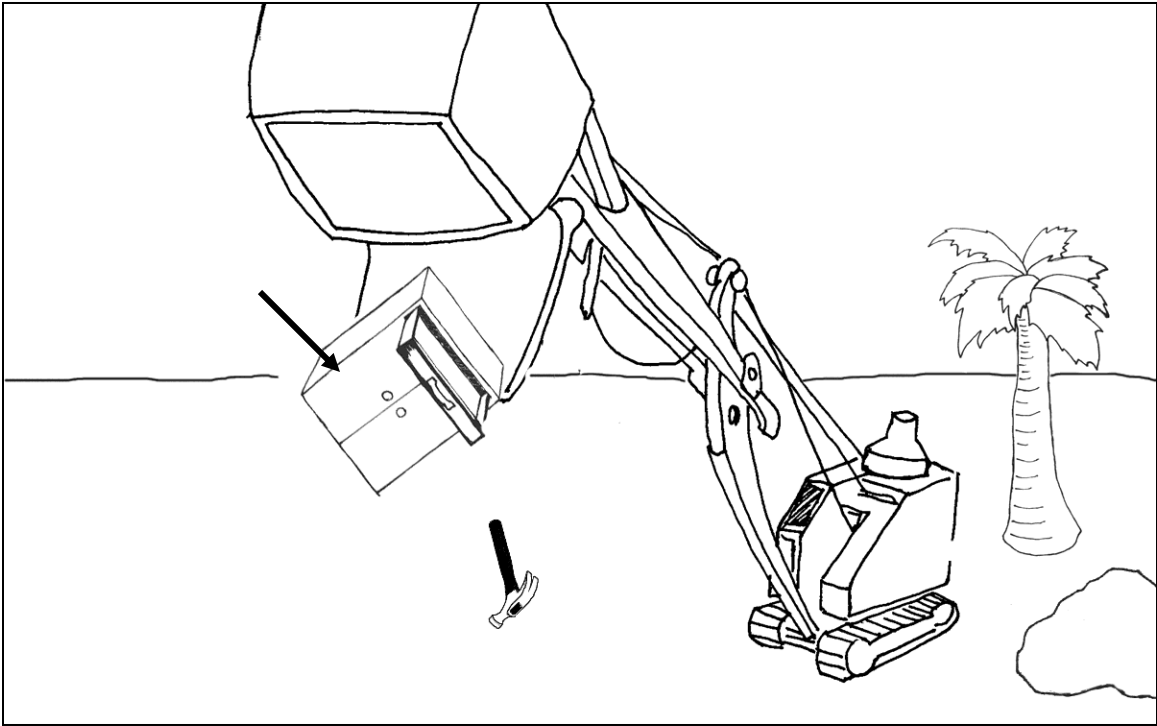

Problem 4-2a

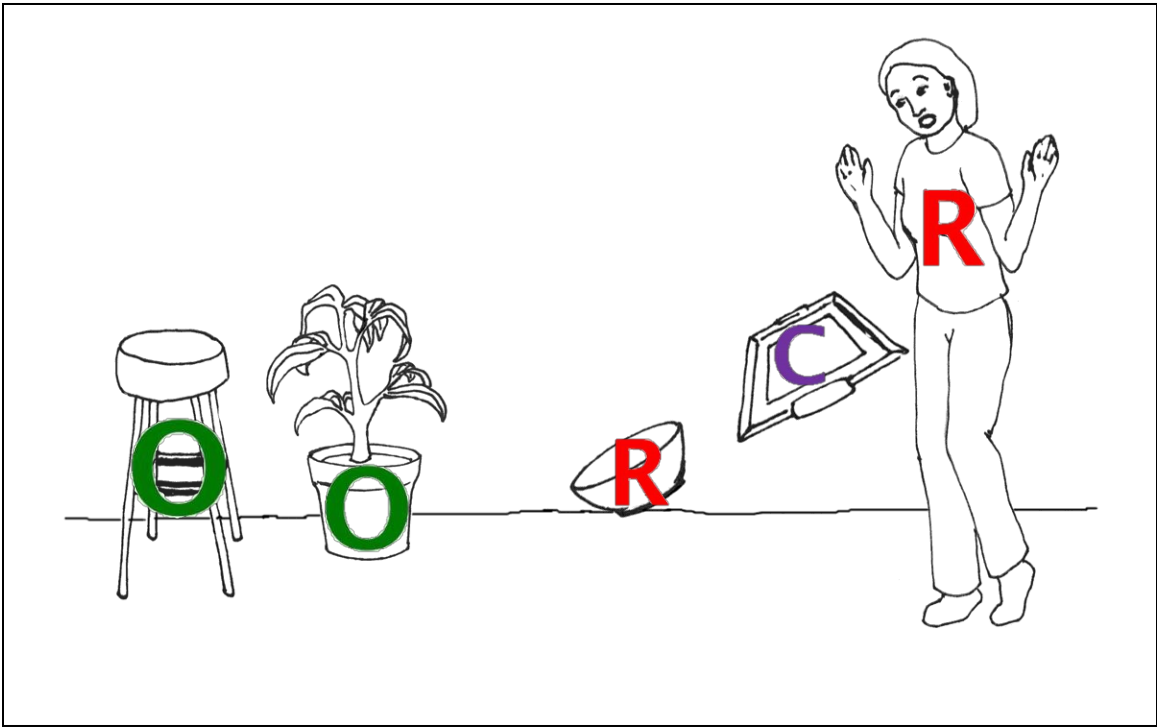
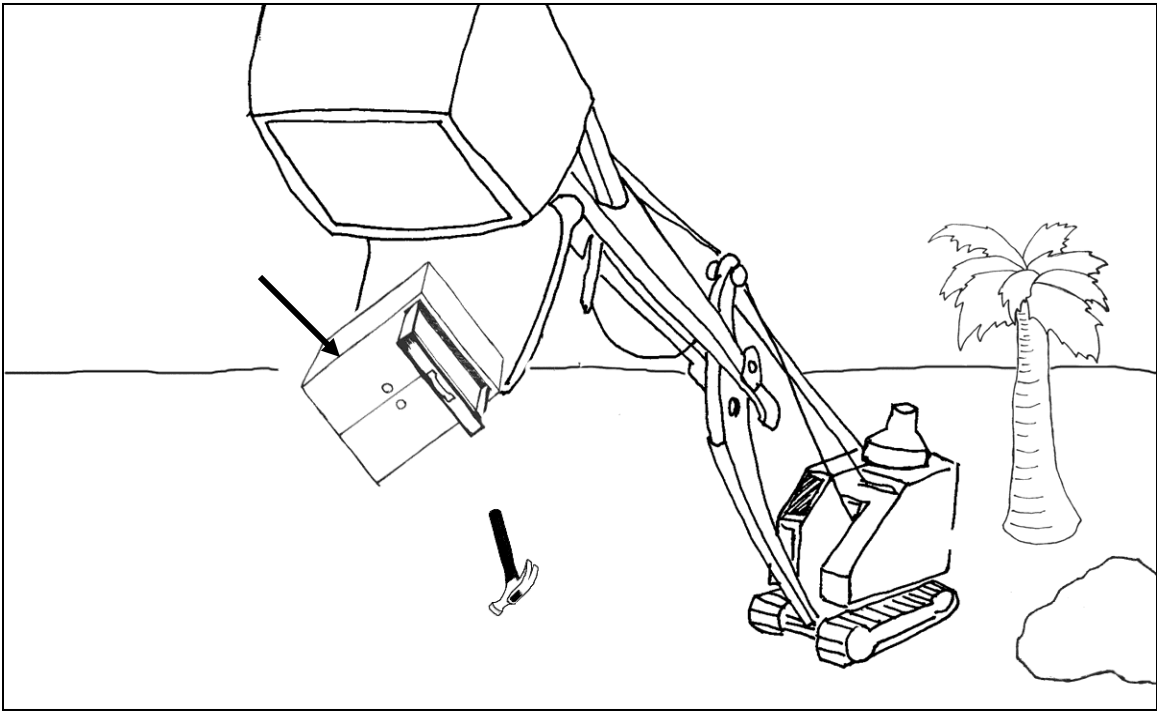

Problem 4-2b

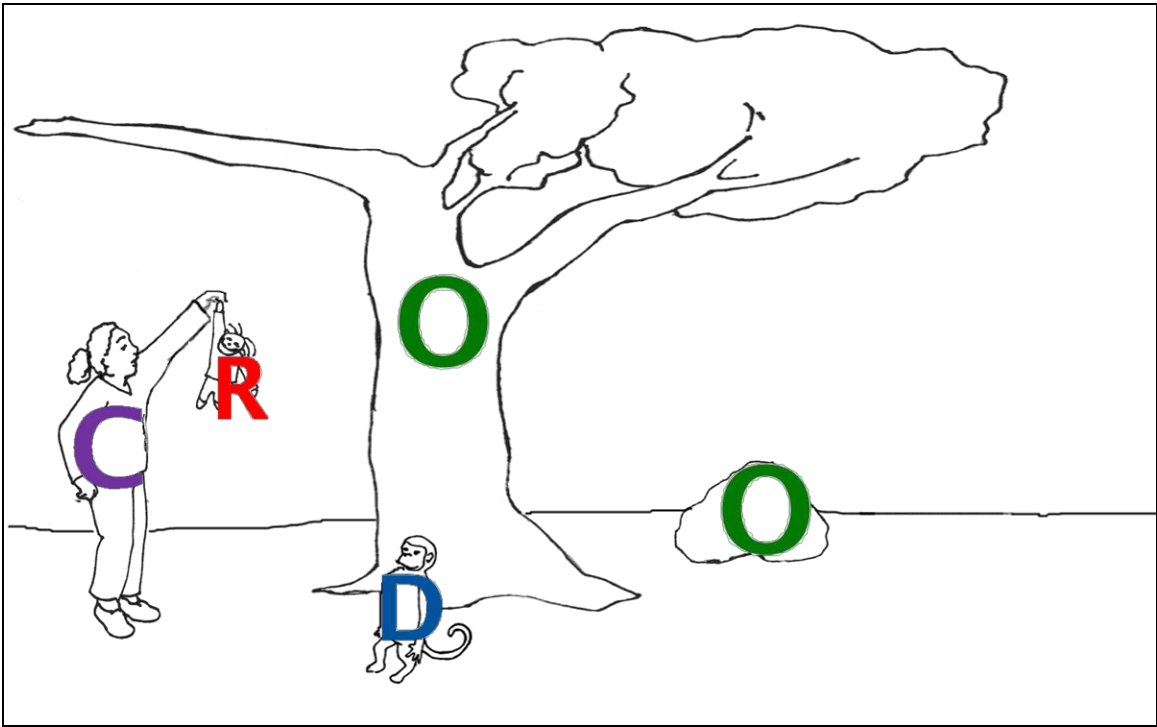
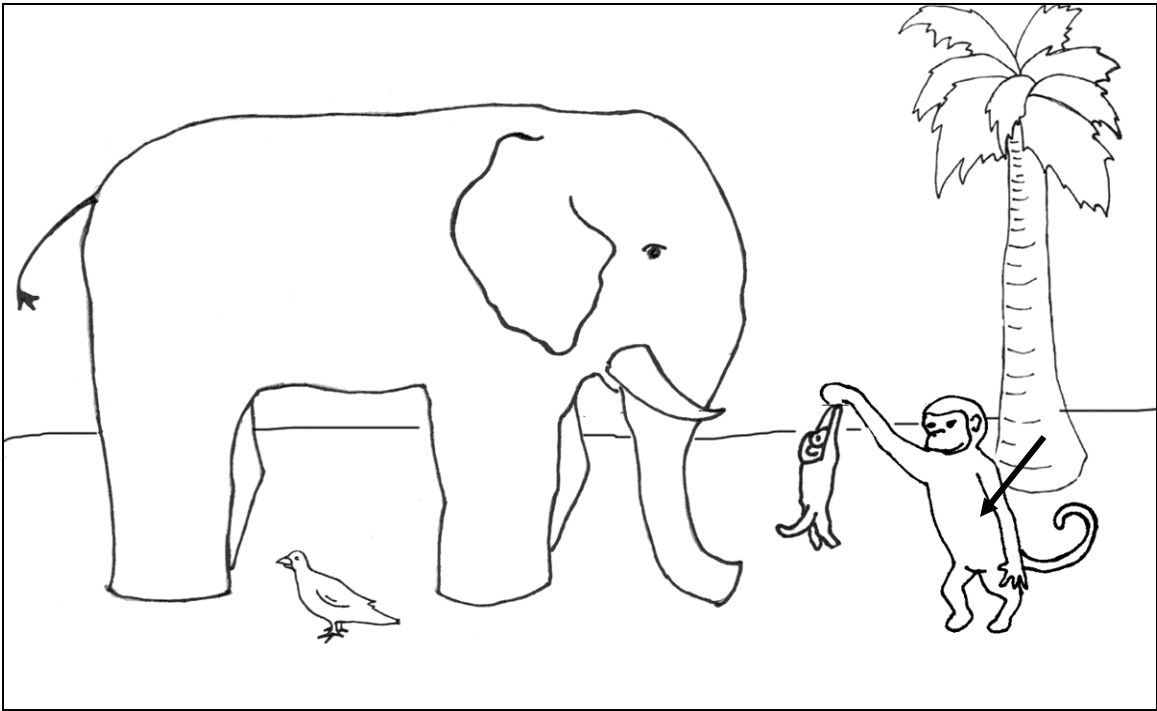

Problem 5-1a

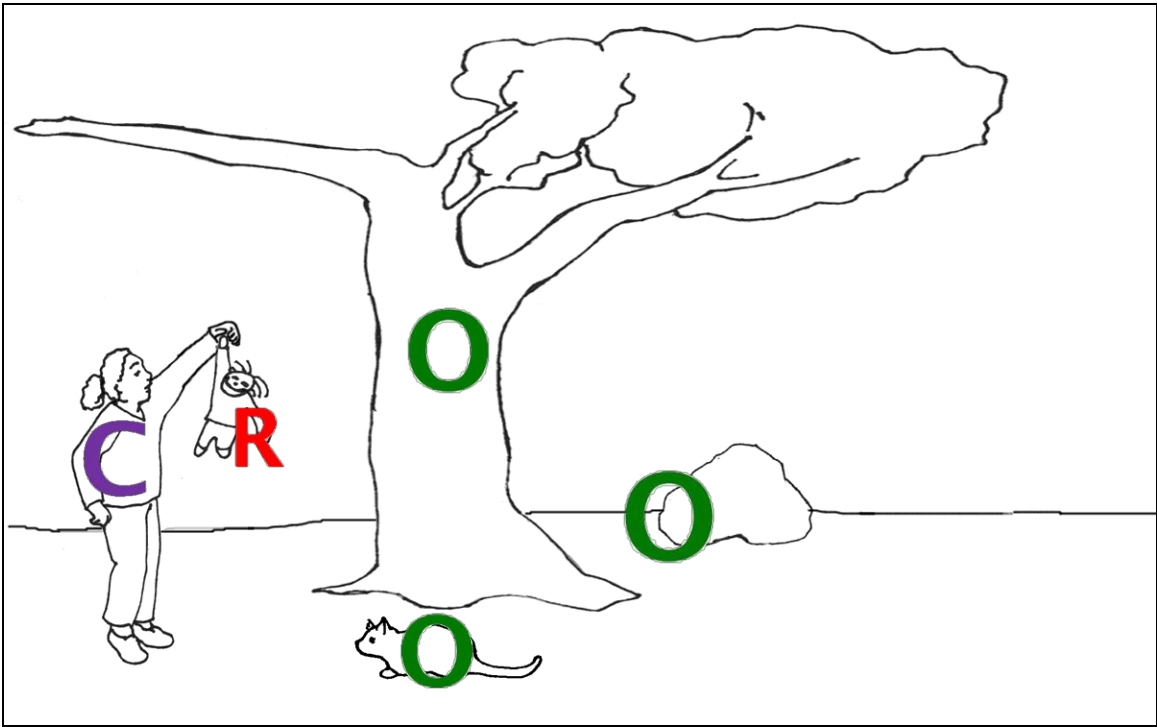
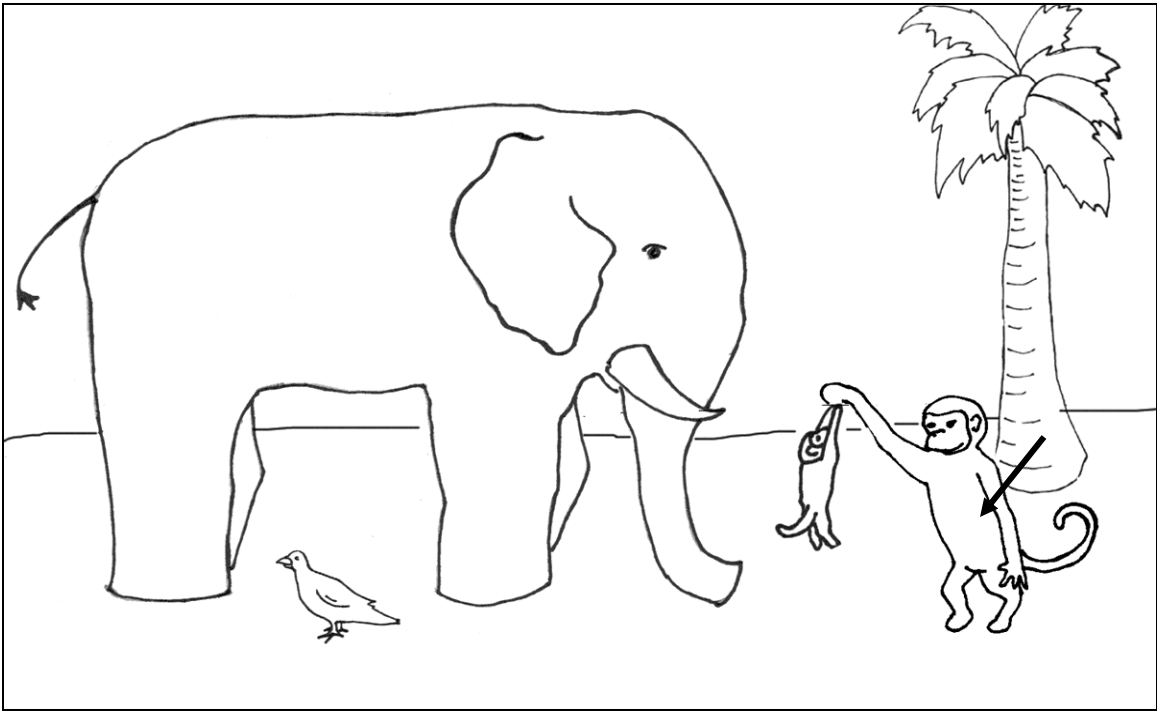

Problem 5-1 b

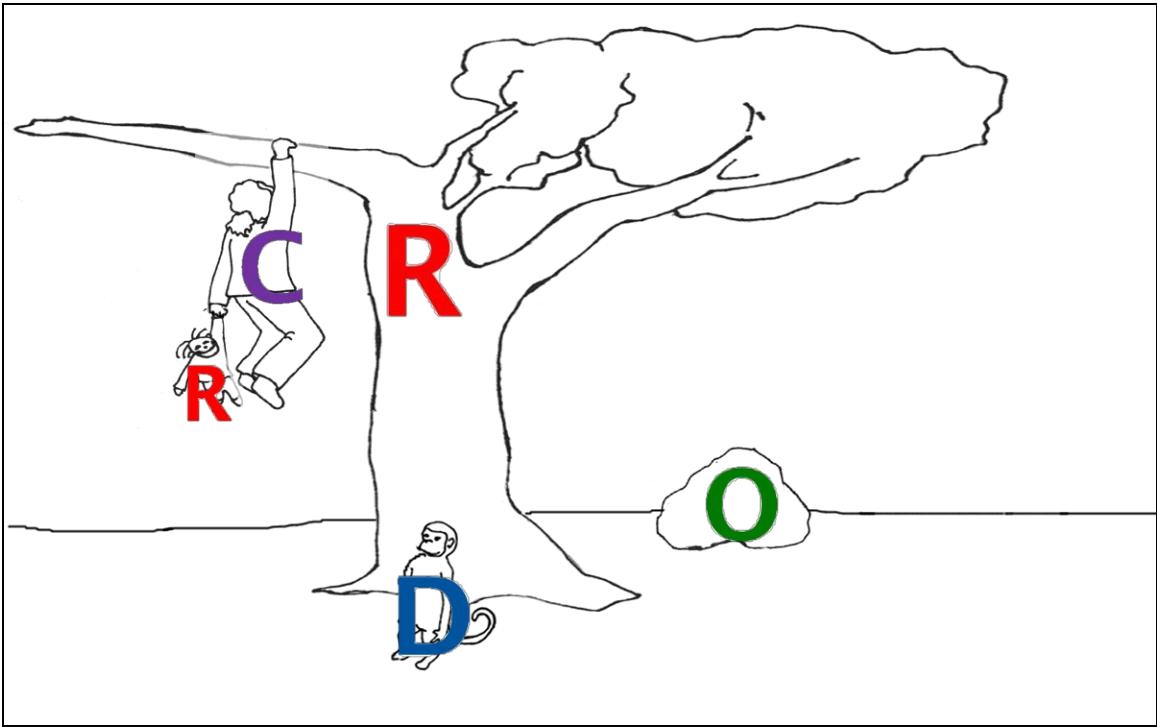
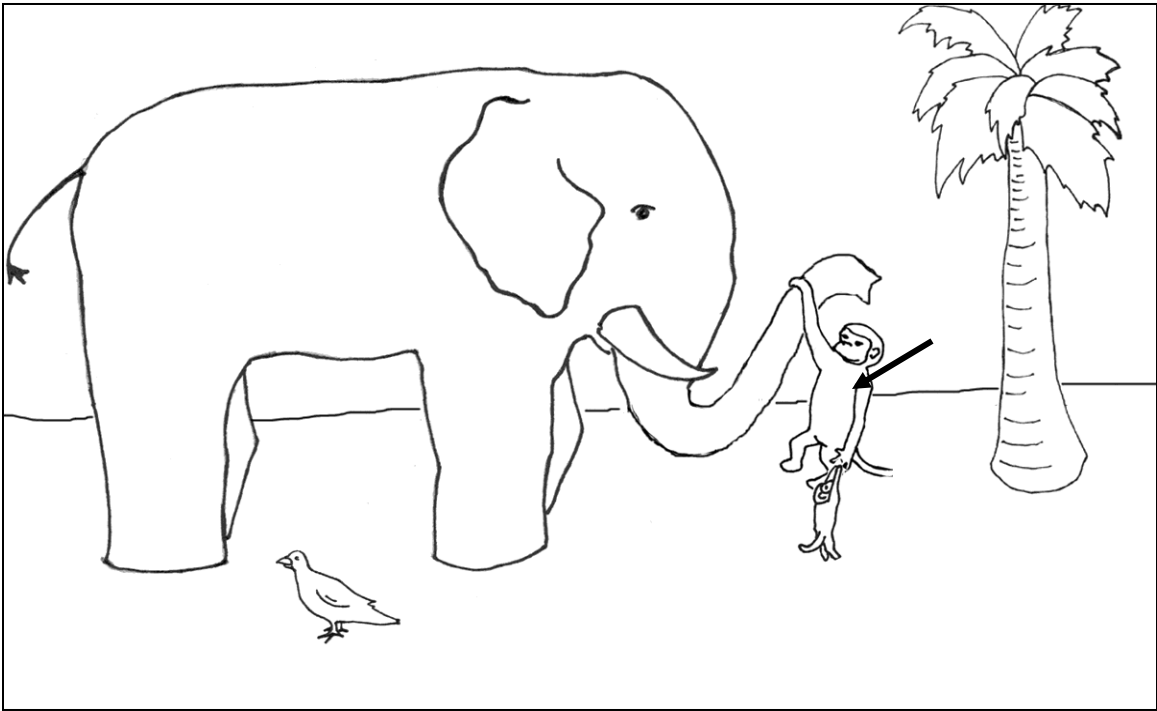

Problem 5-2a

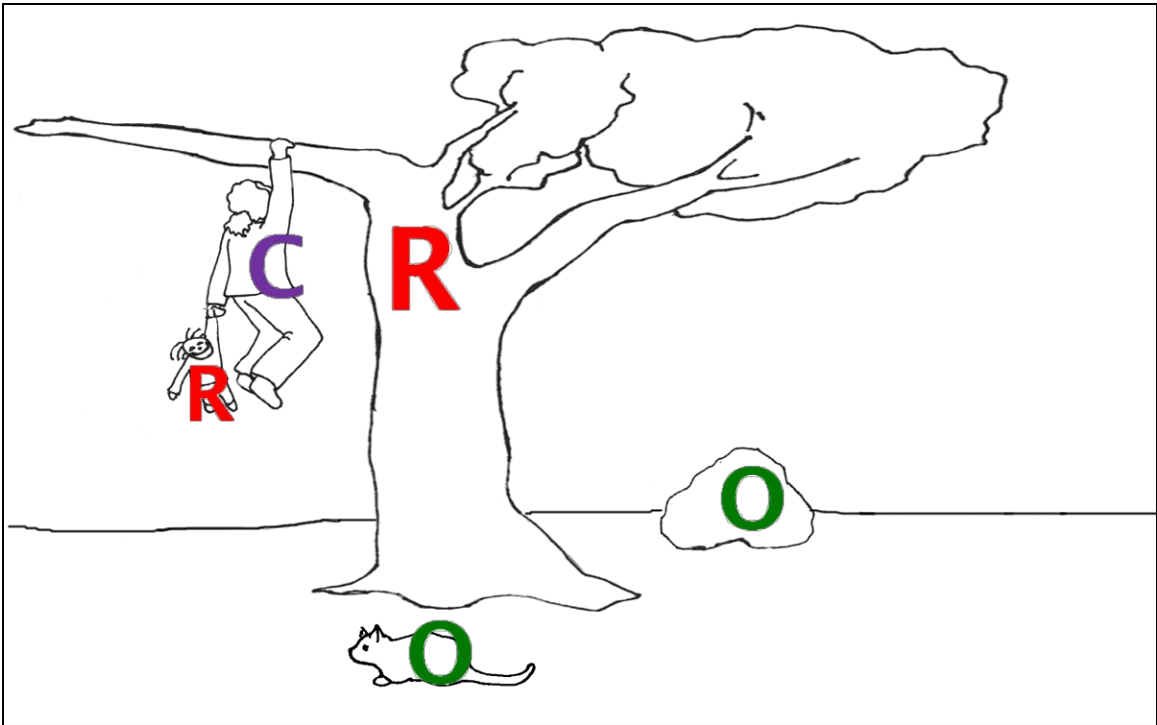
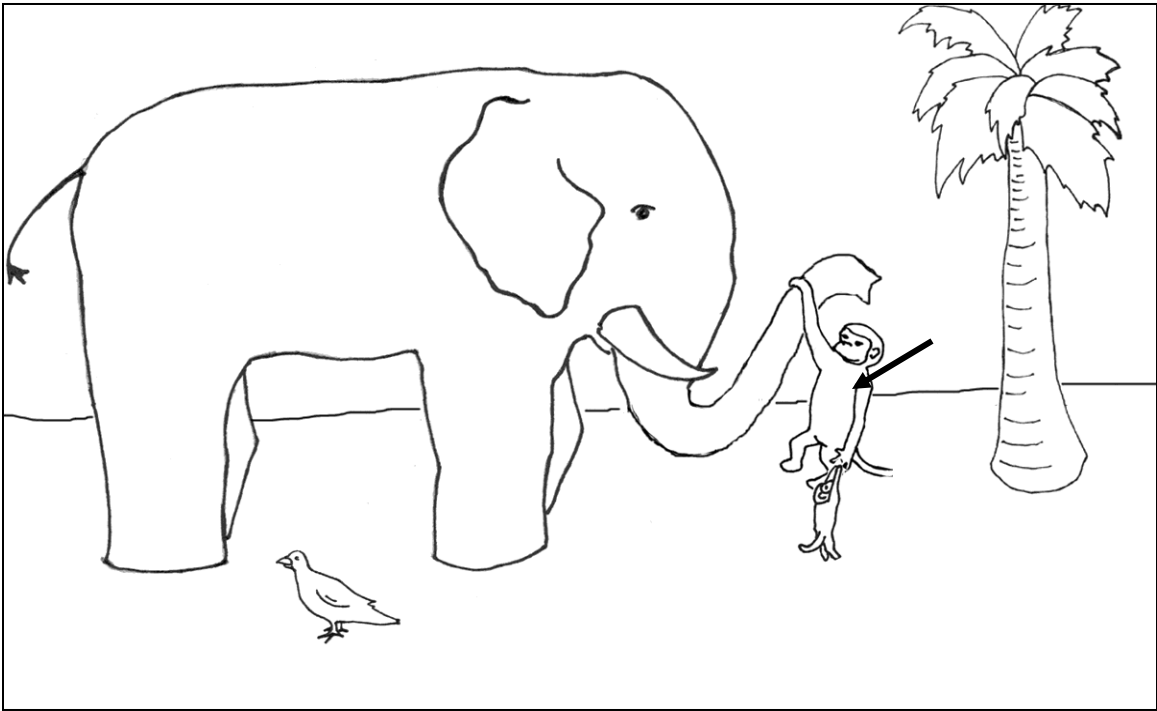

Problem 5-2b

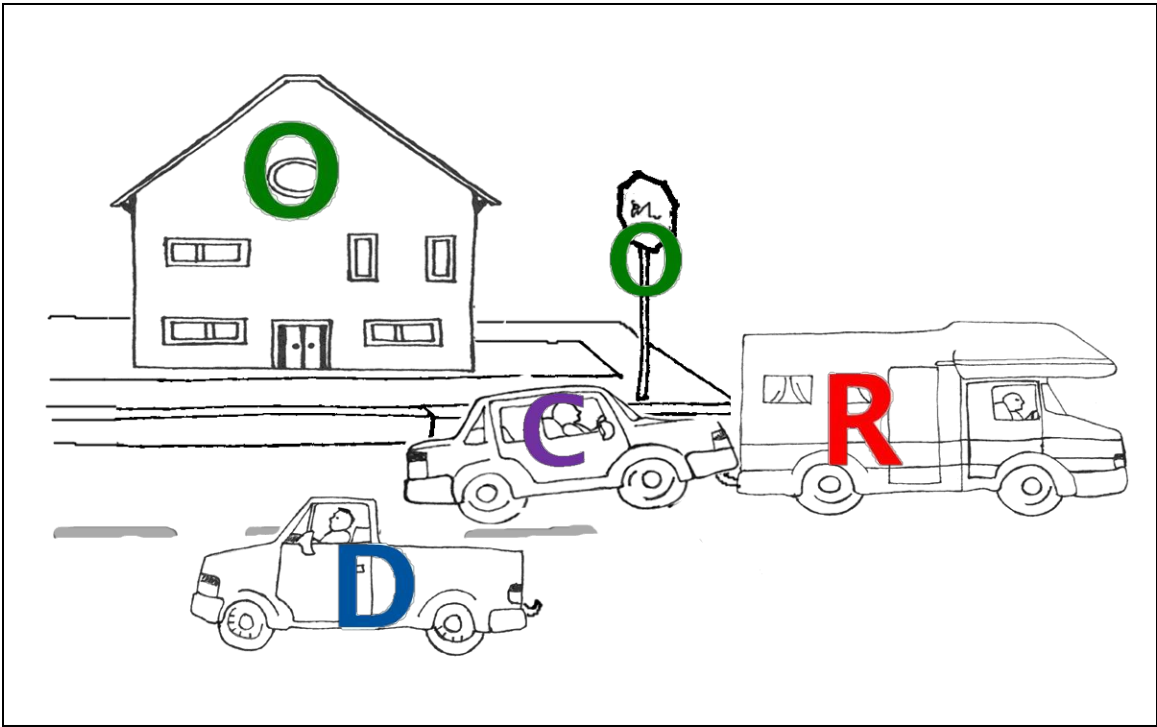
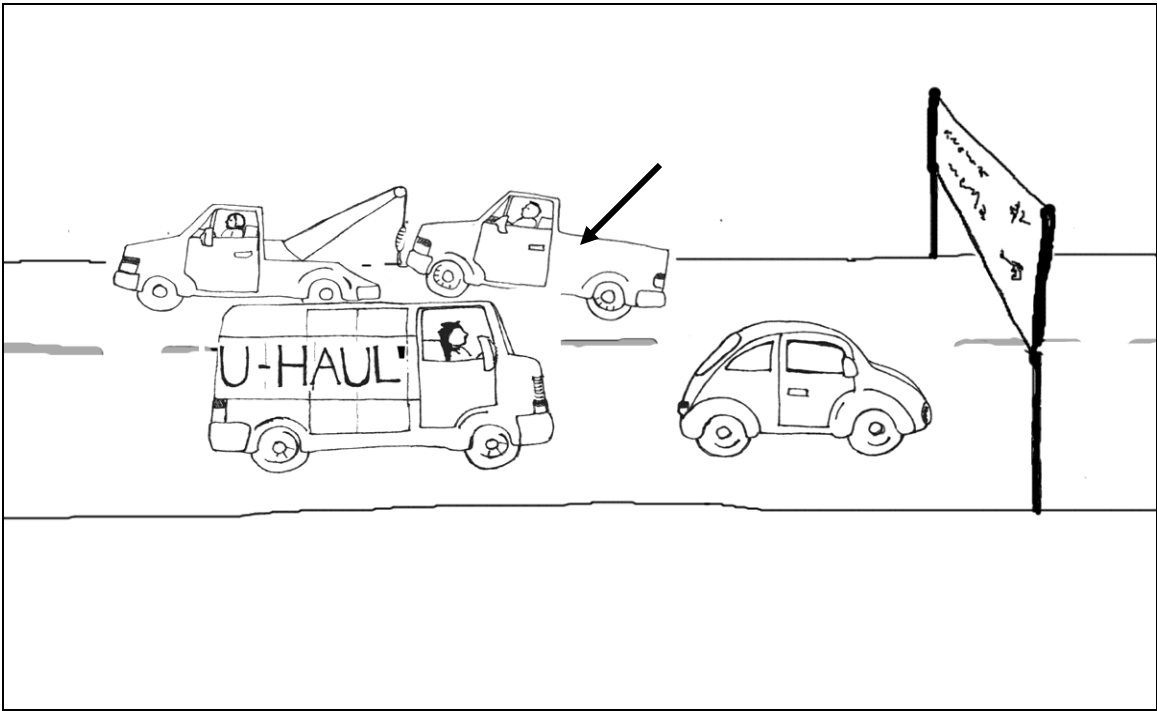

Problem 6-1a

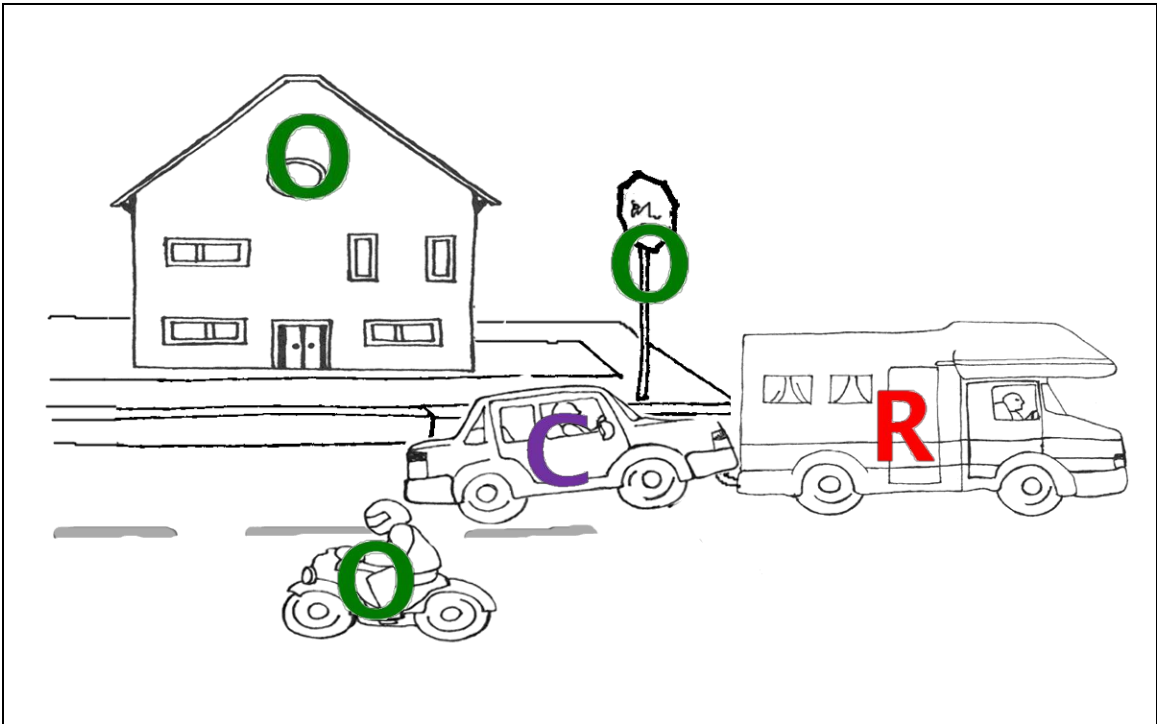
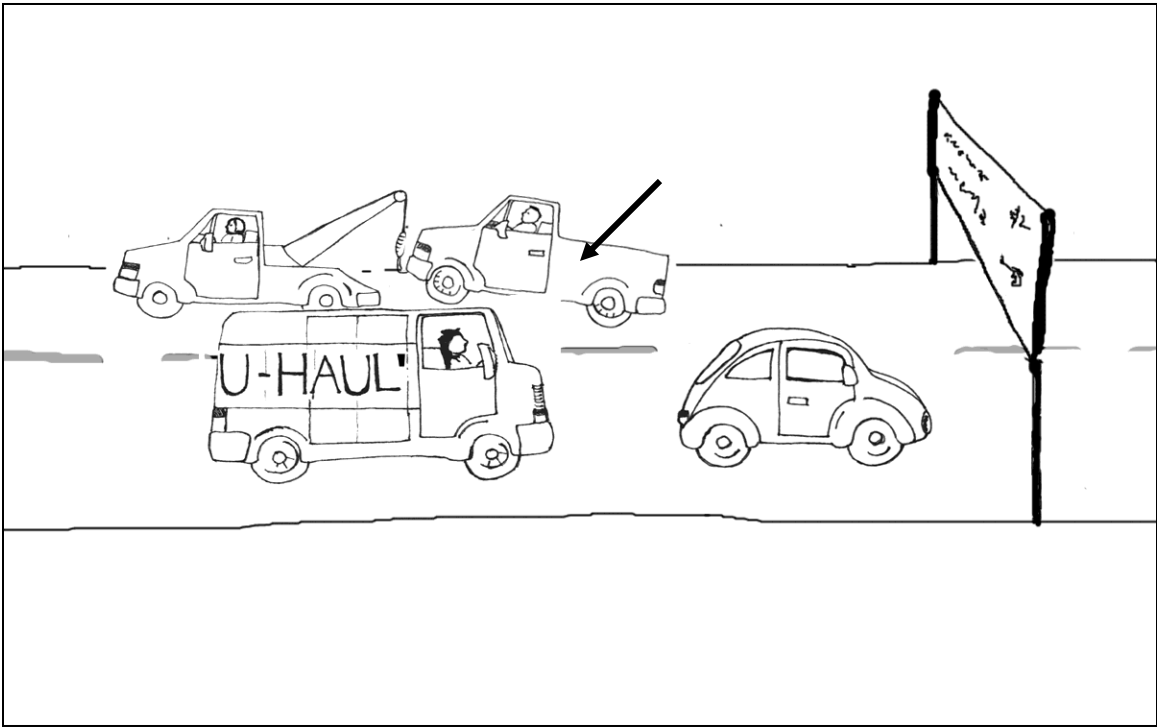

Problem 6-1 b

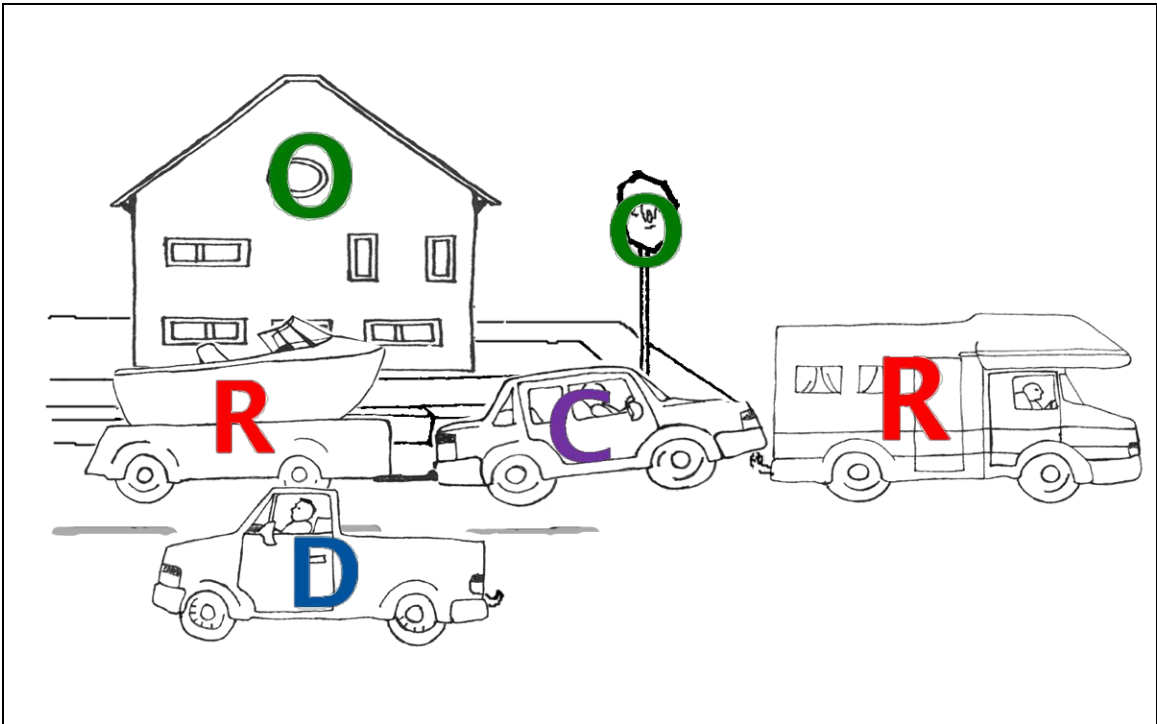
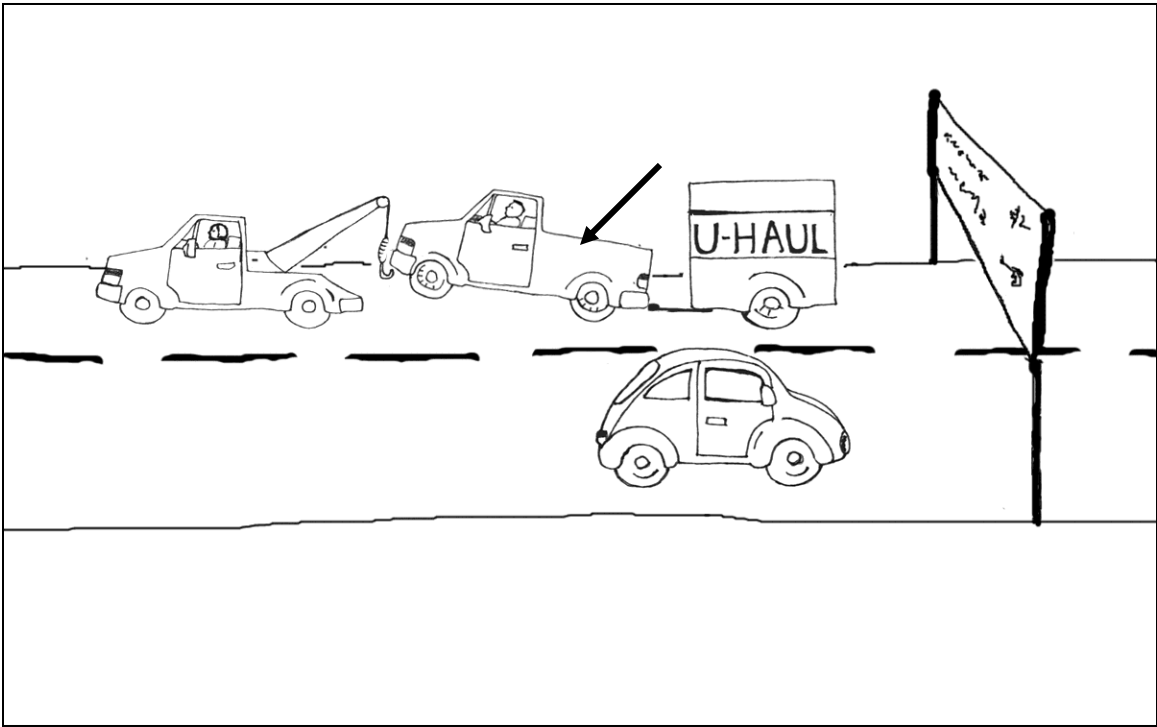

Problem 6-2a

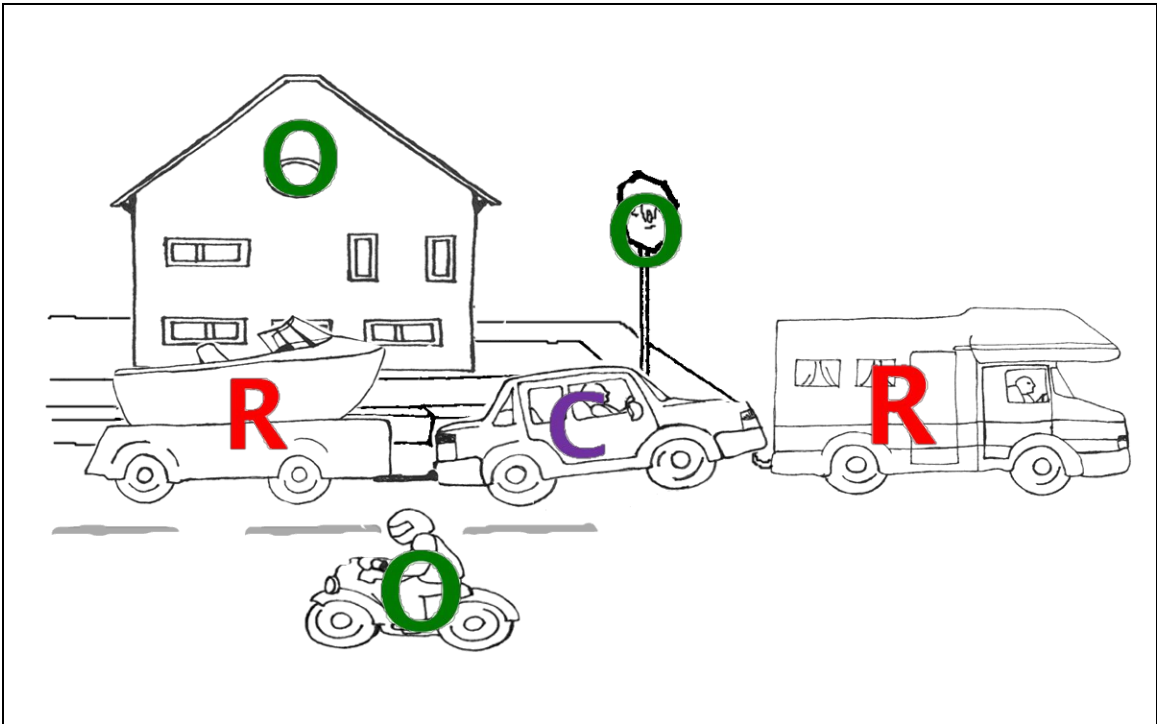
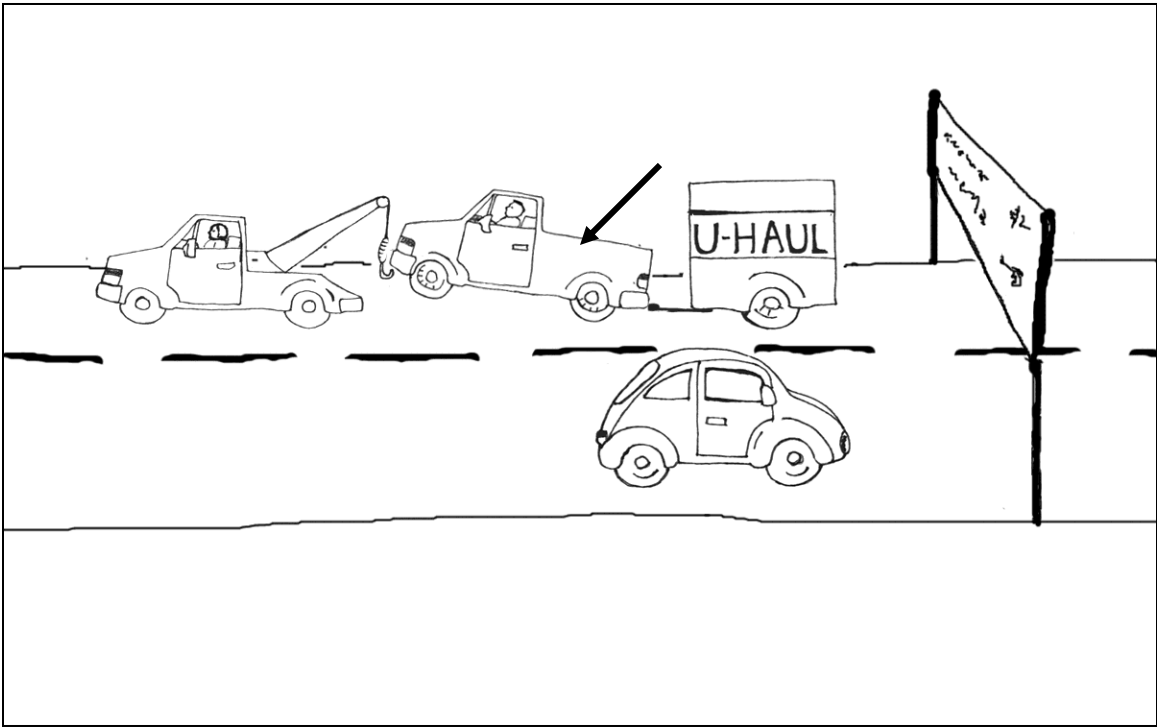

Problem 6-2b

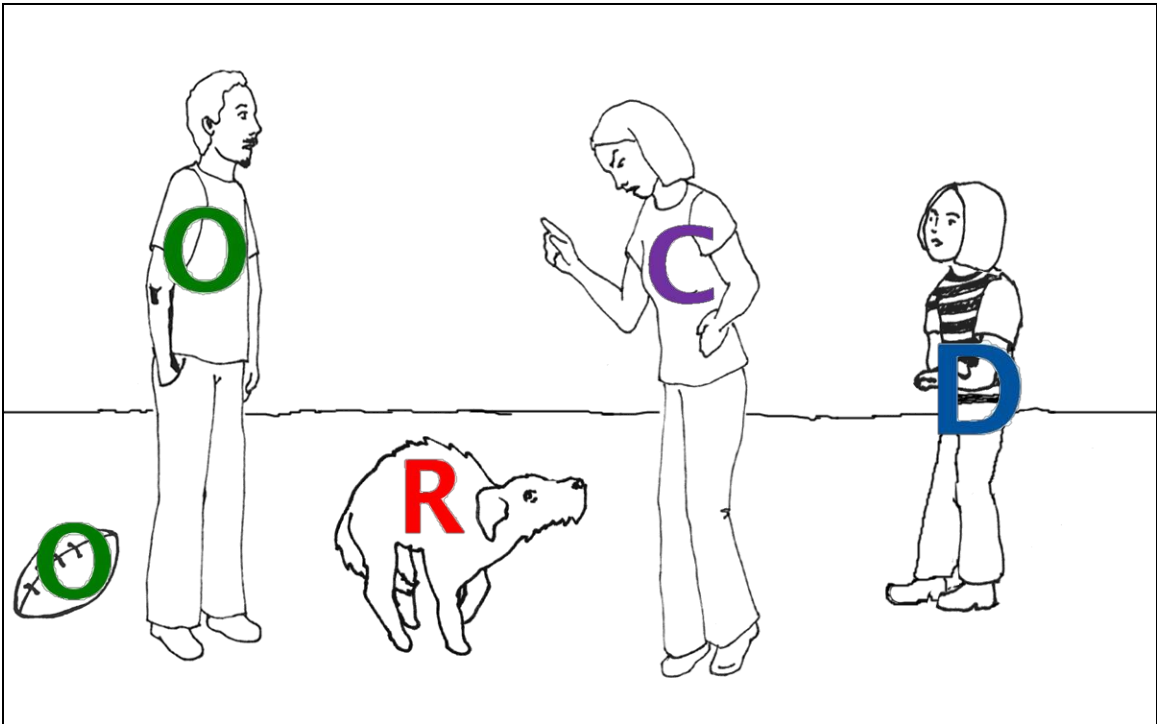
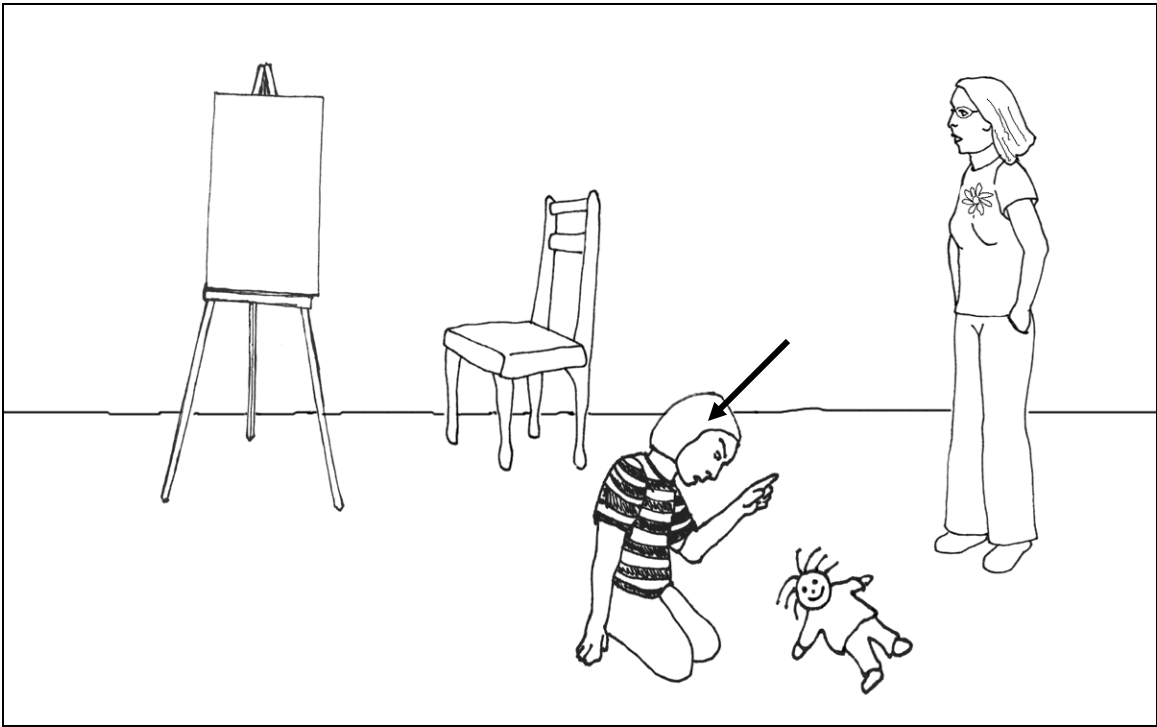

Problem 7-1a

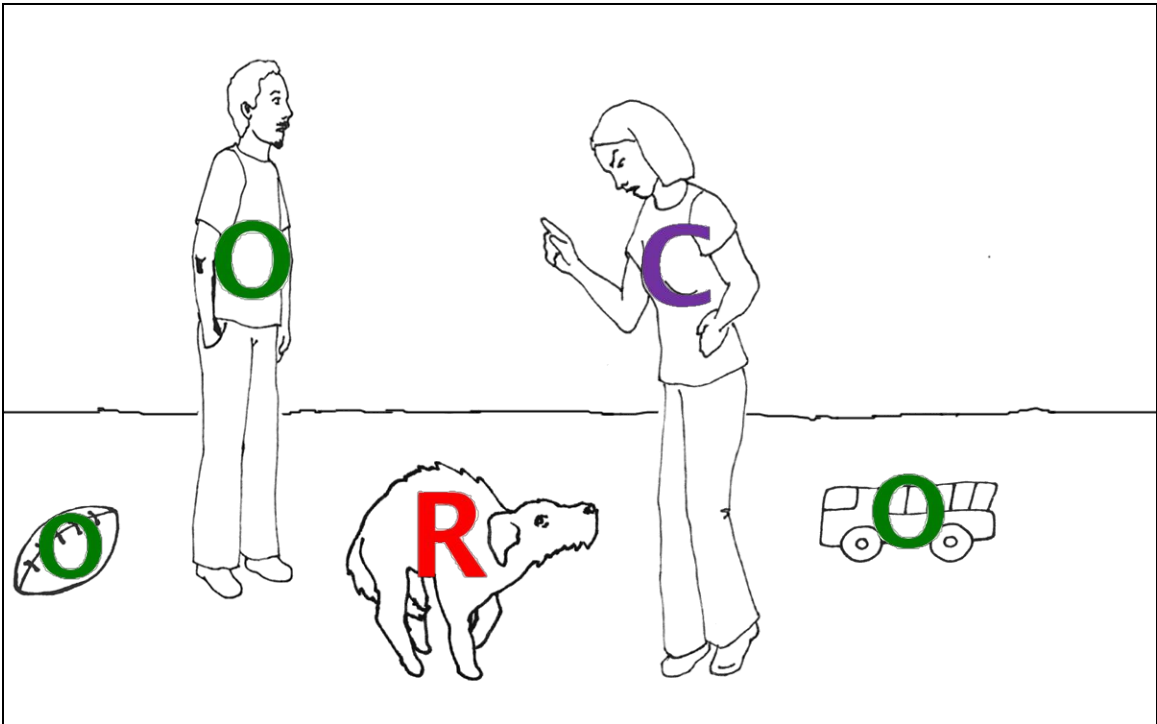
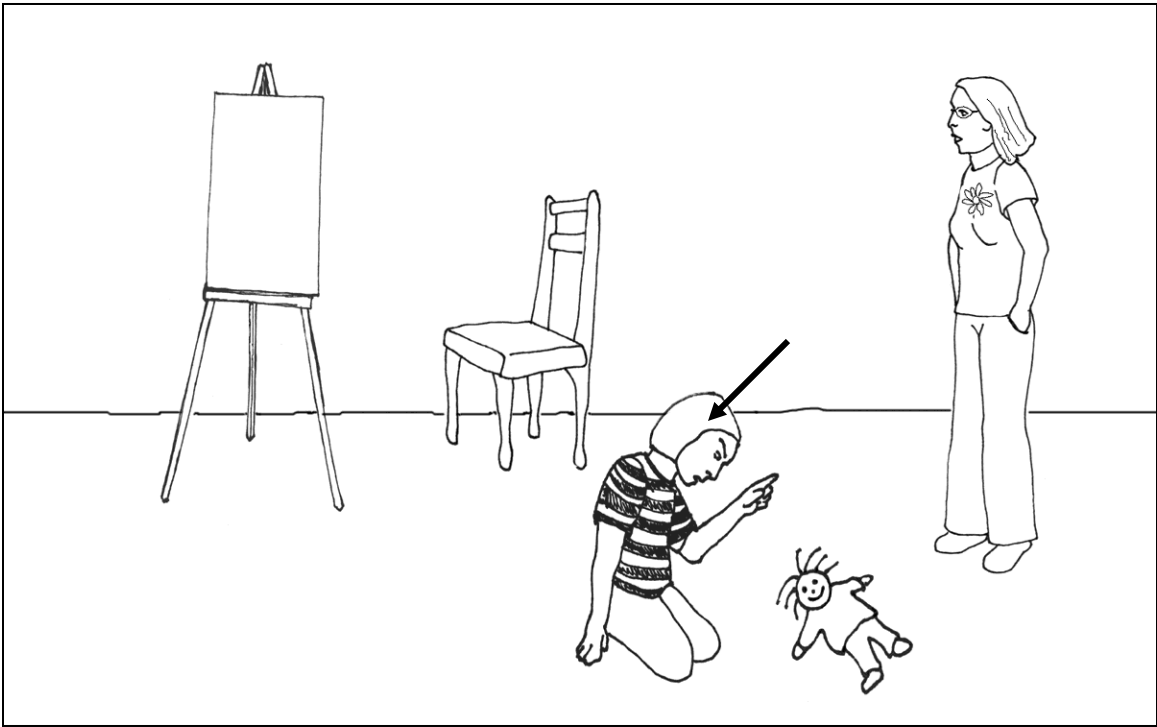

Problem 7-1 b

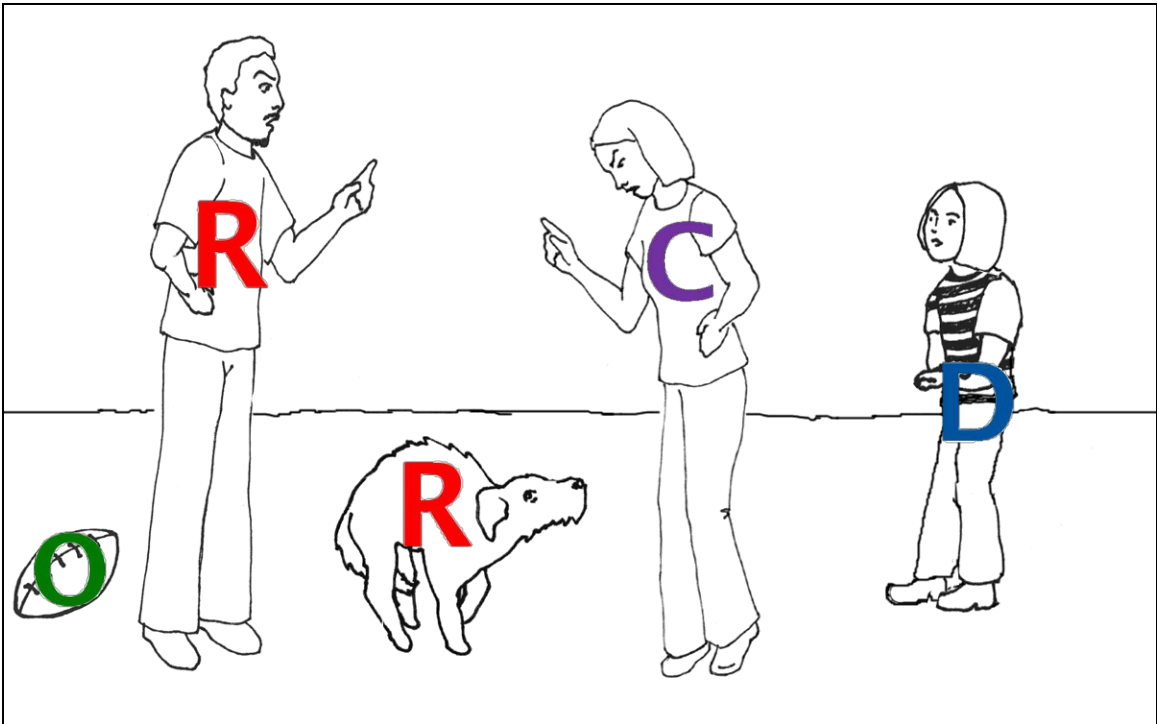
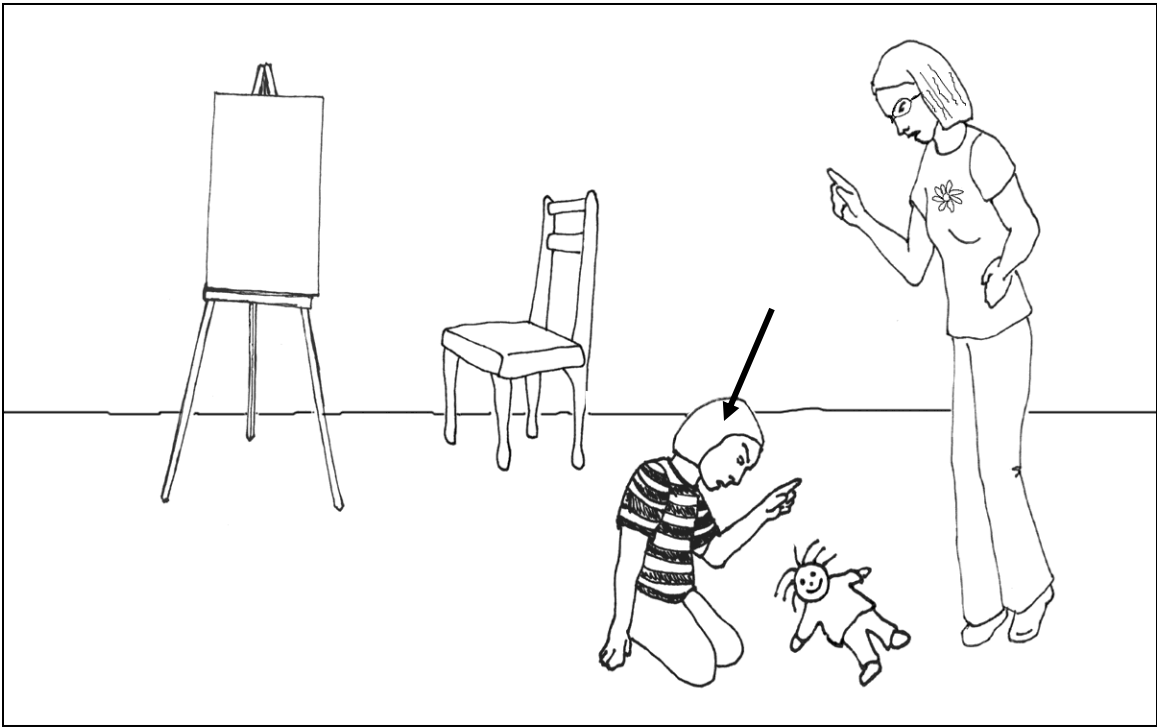

Problem 7-2a

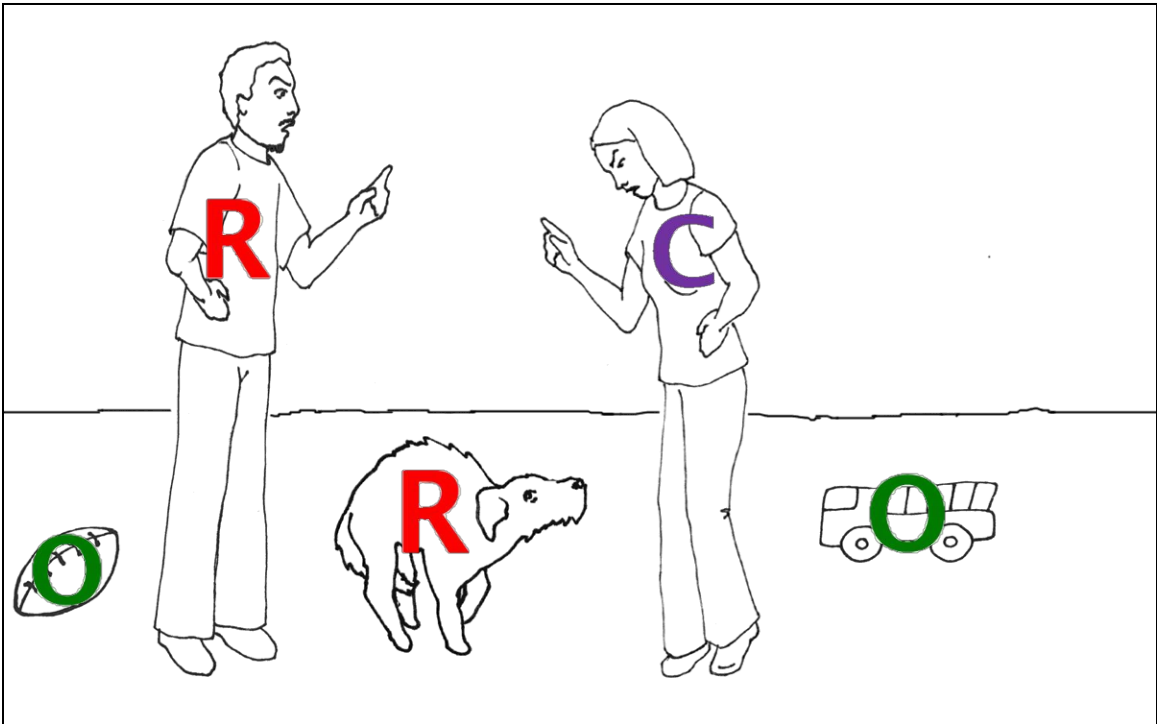
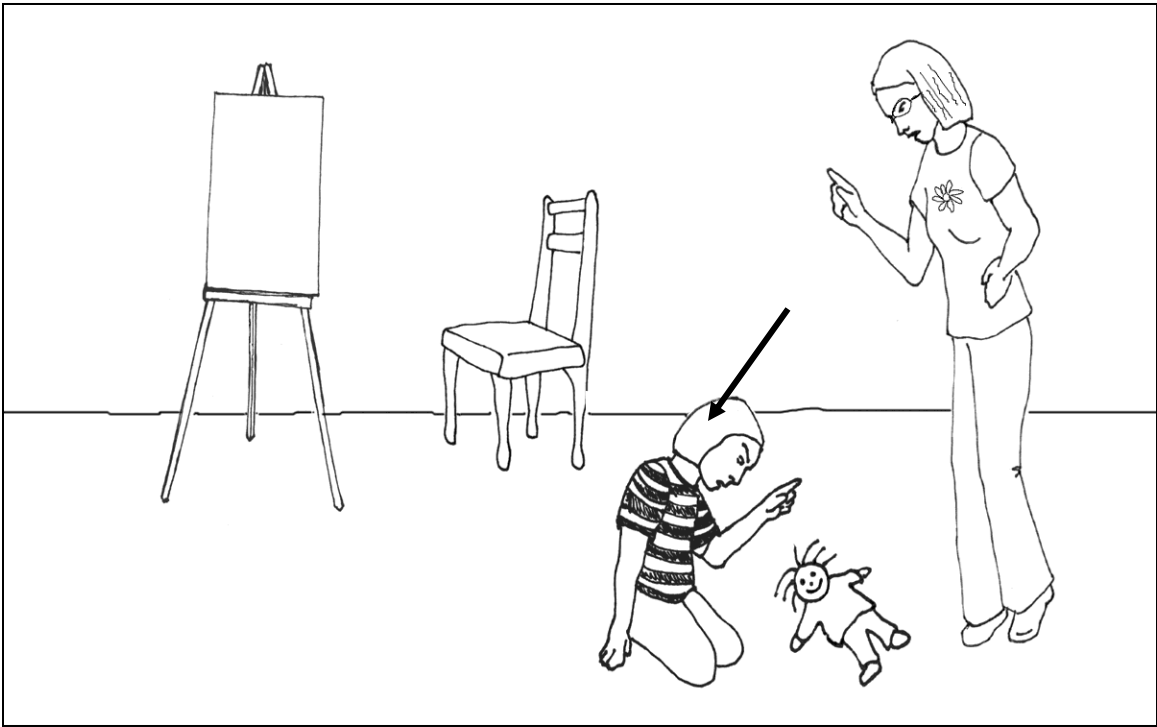

Problem 7-2b

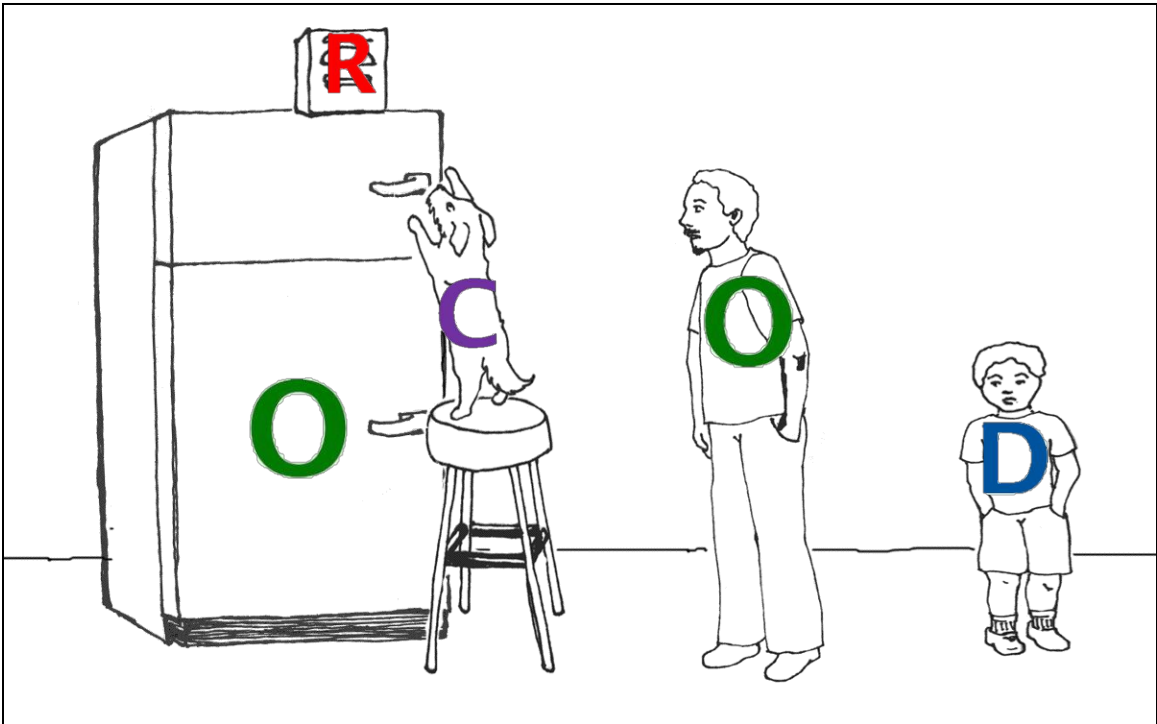
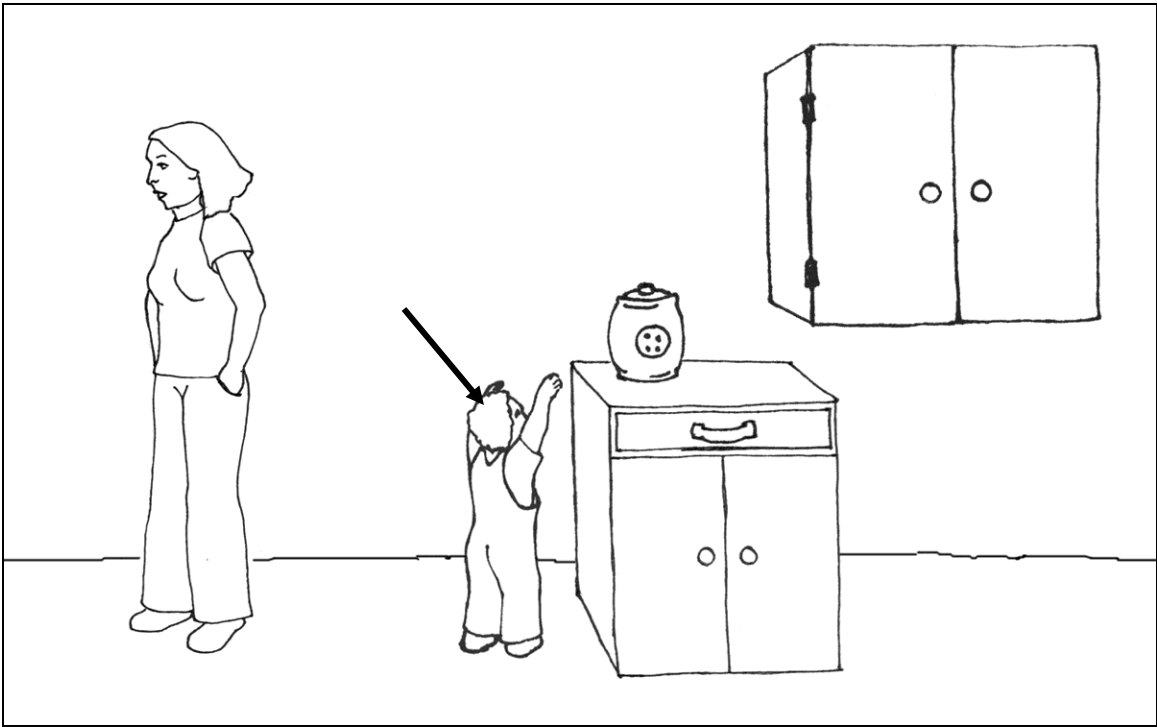

Problem 8-1a

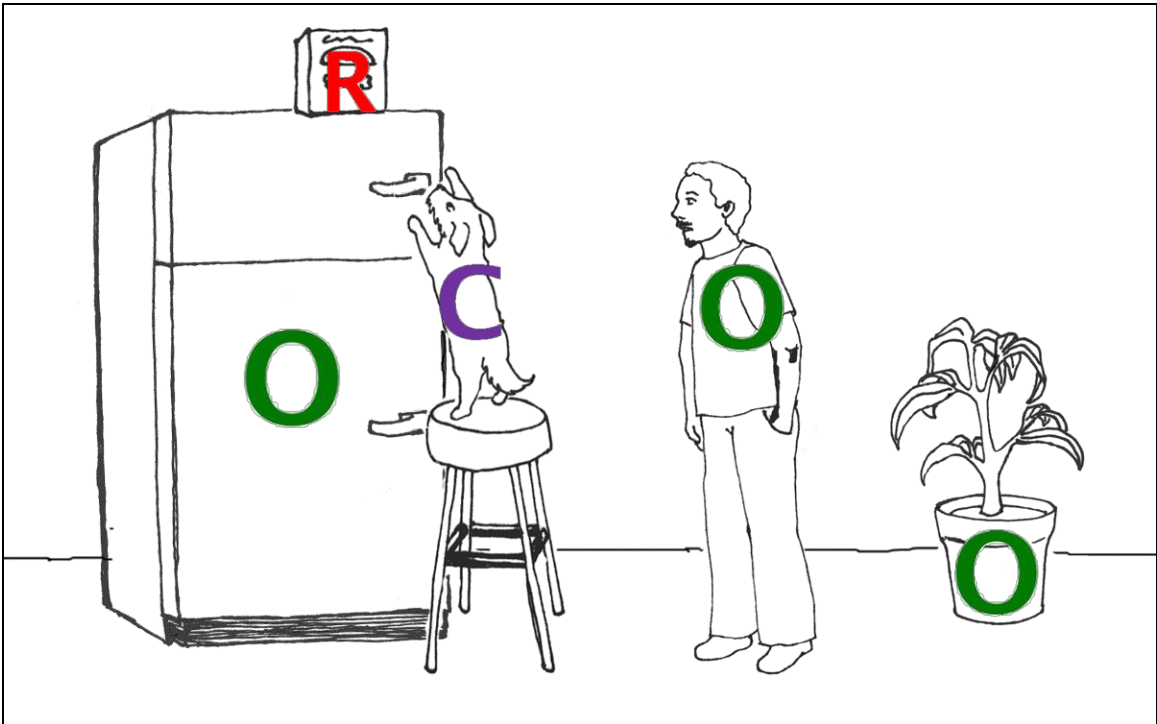
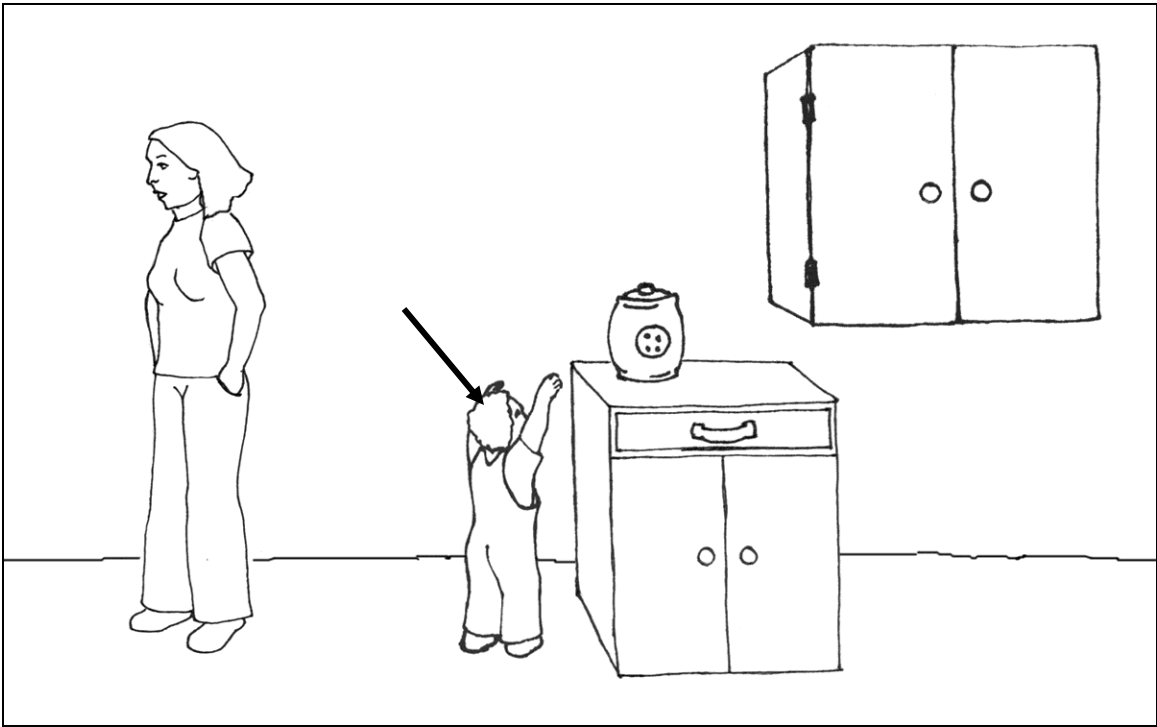

Problem 8-1 b

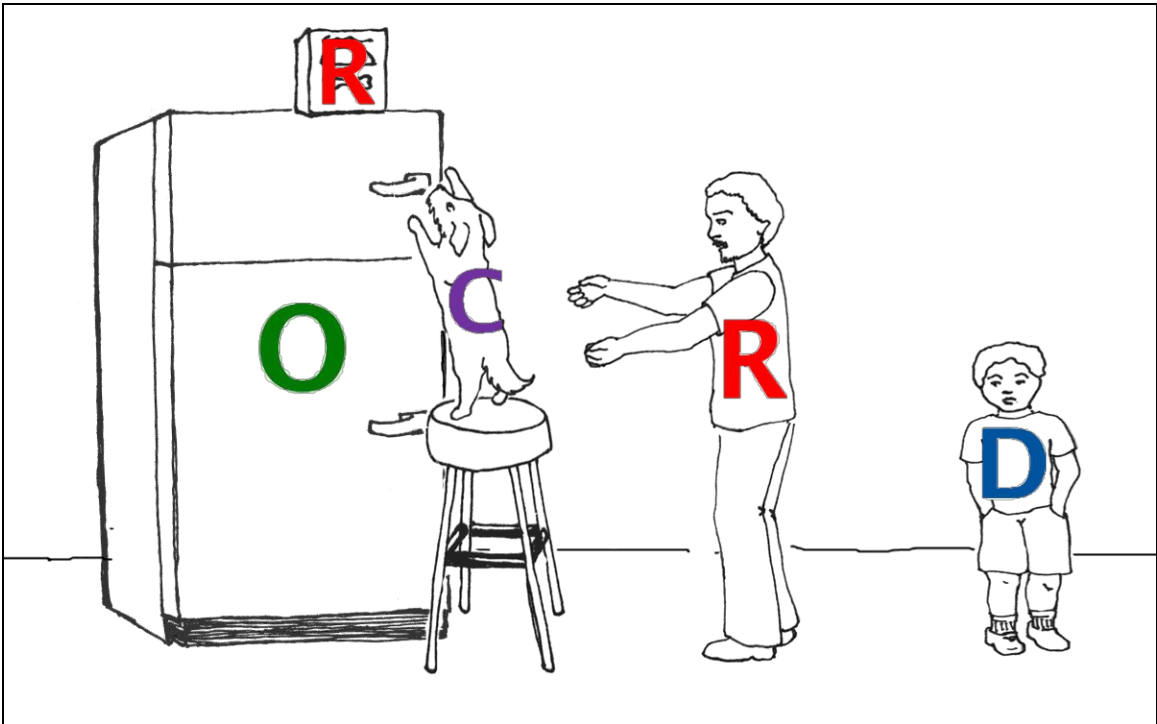
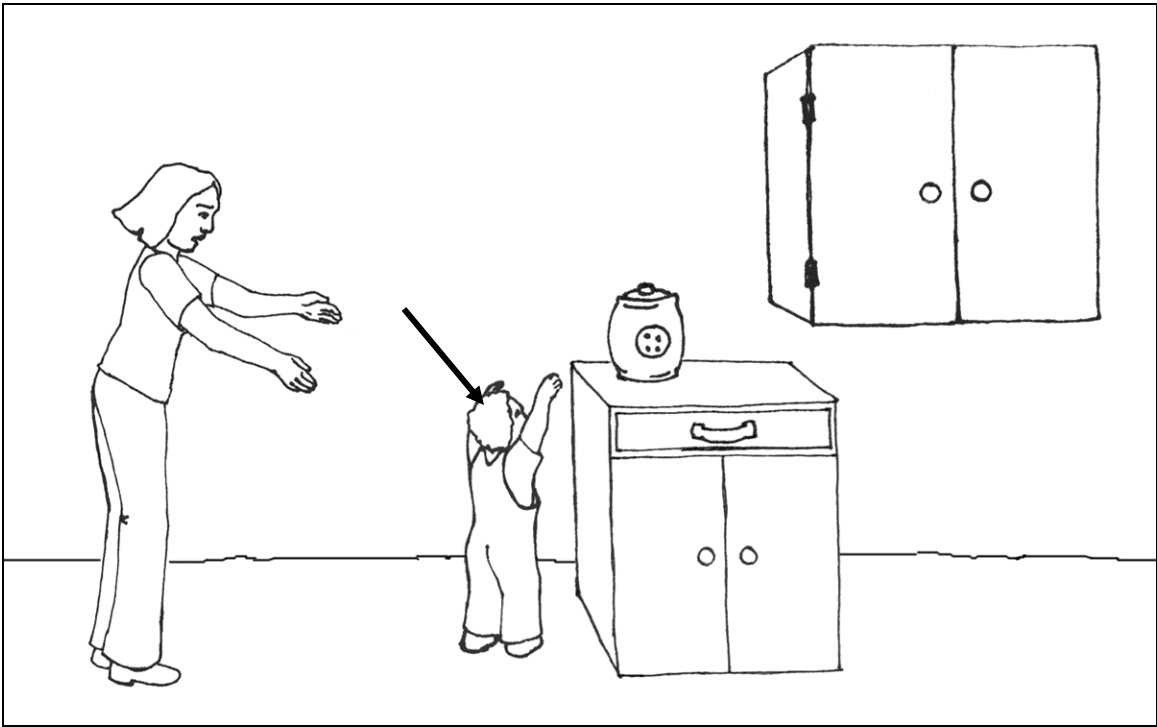

Problem 8-2a

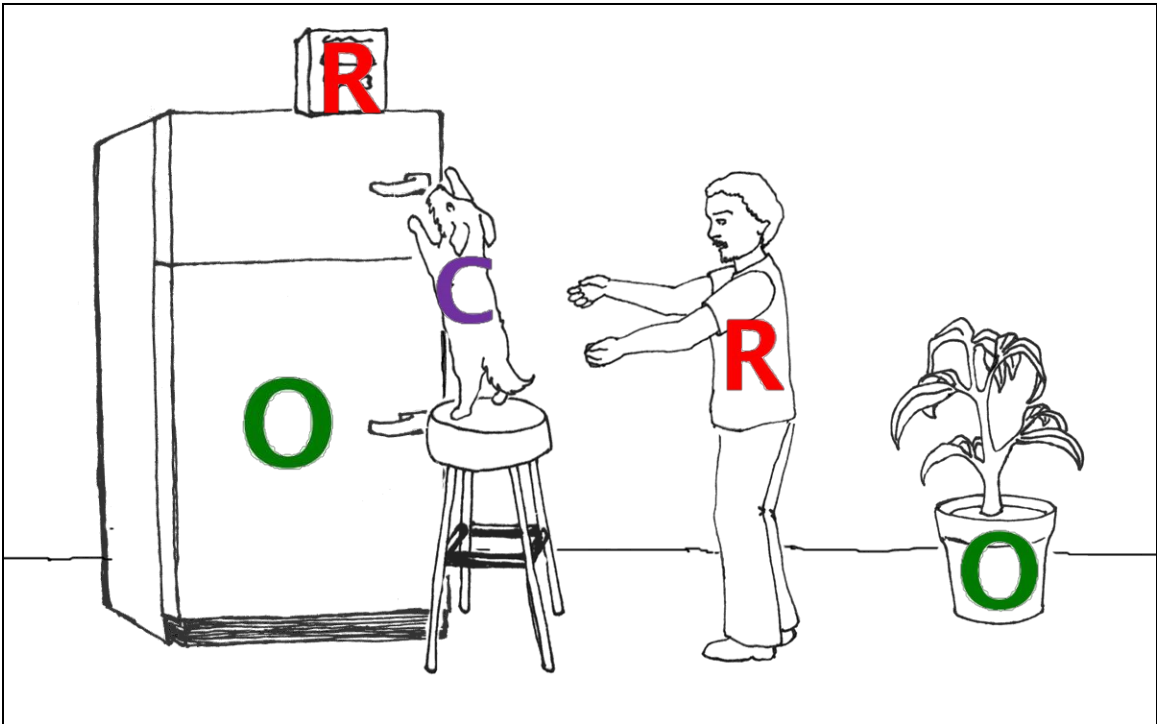
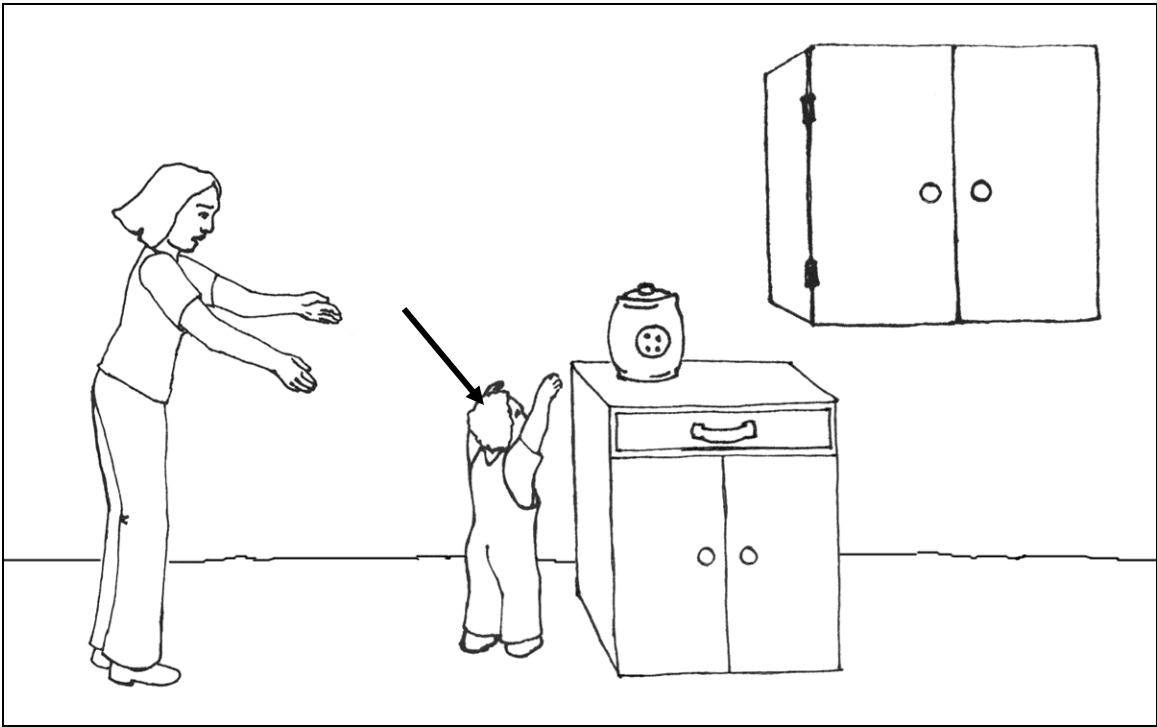

Problem 8-2b

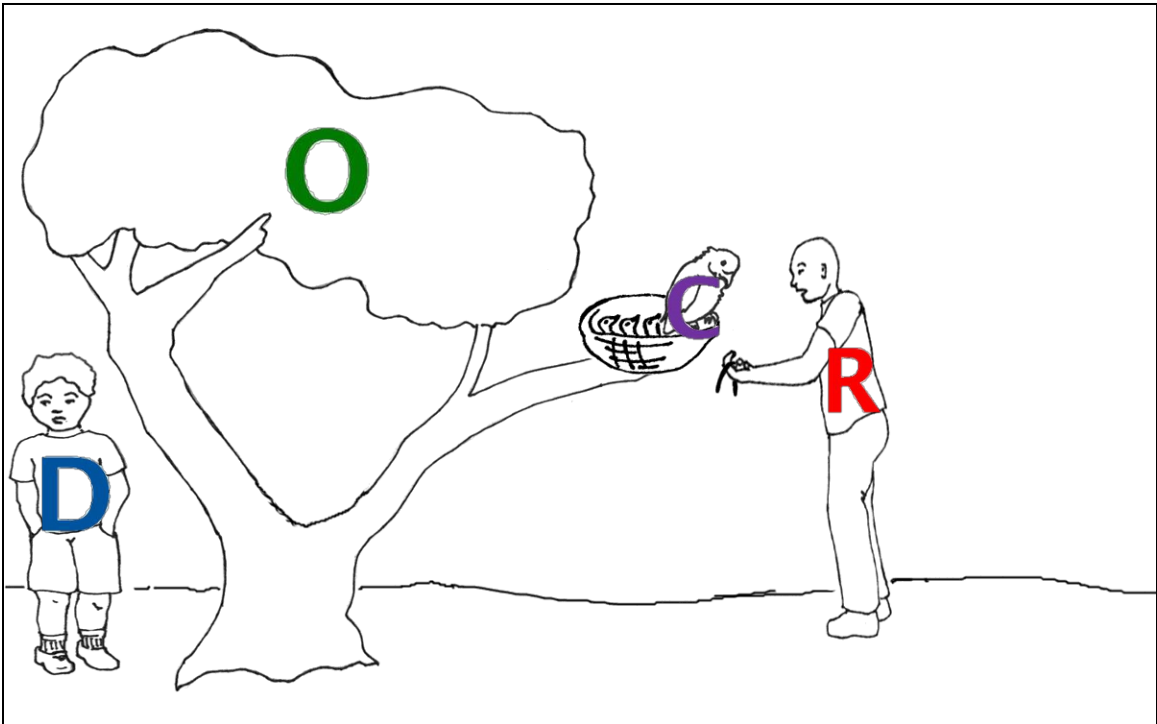
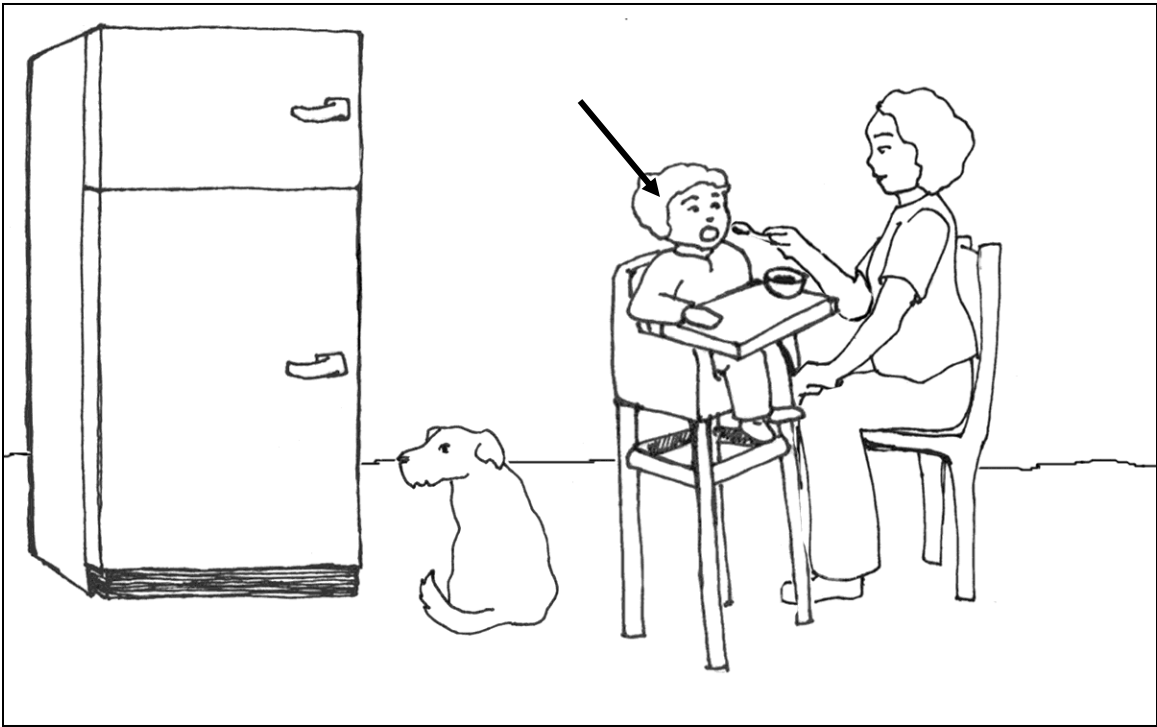

Problem 9-1a

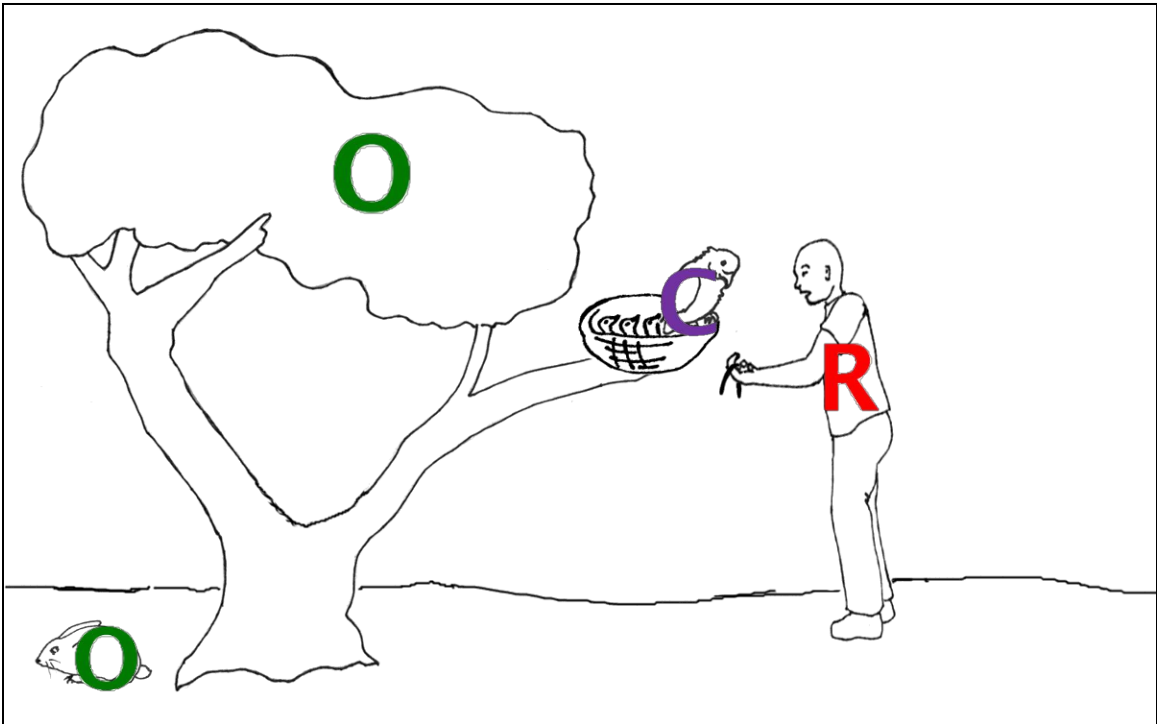
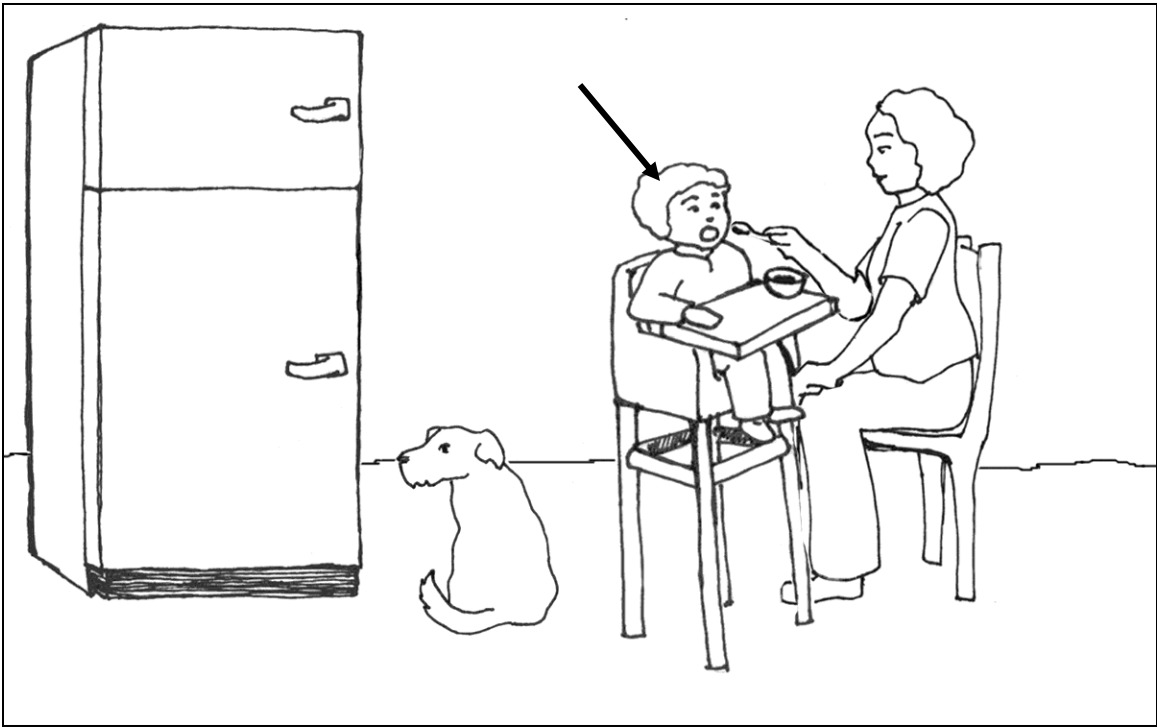

Problem 9-1 b

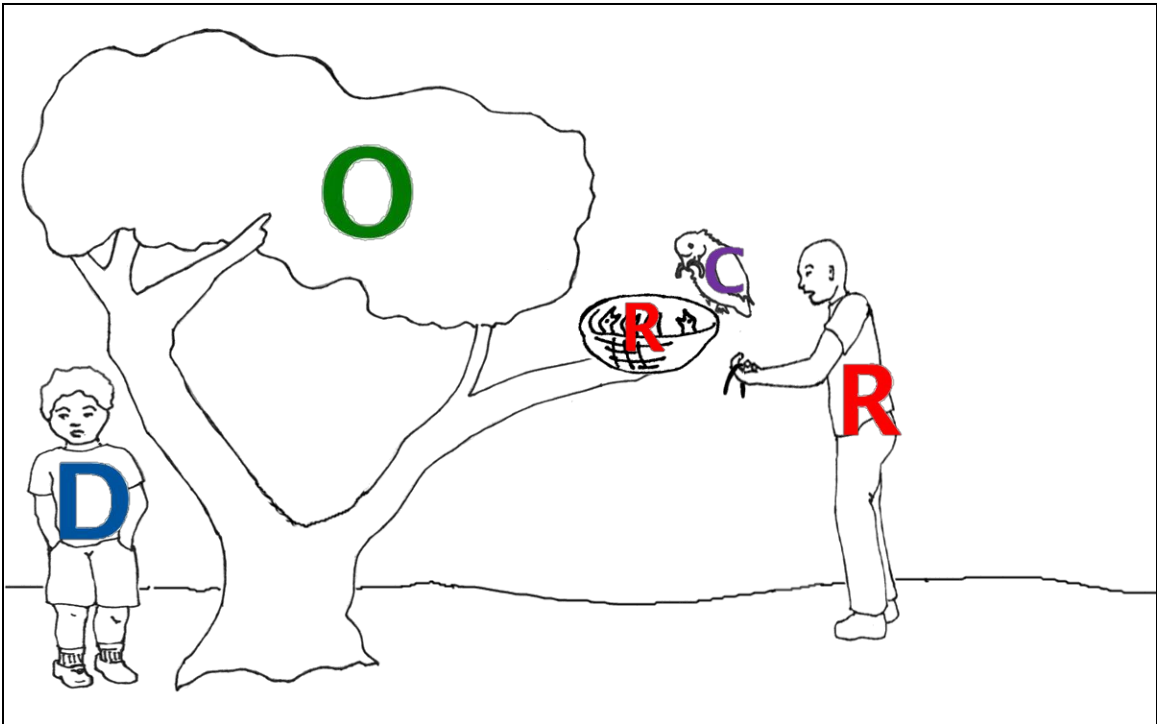
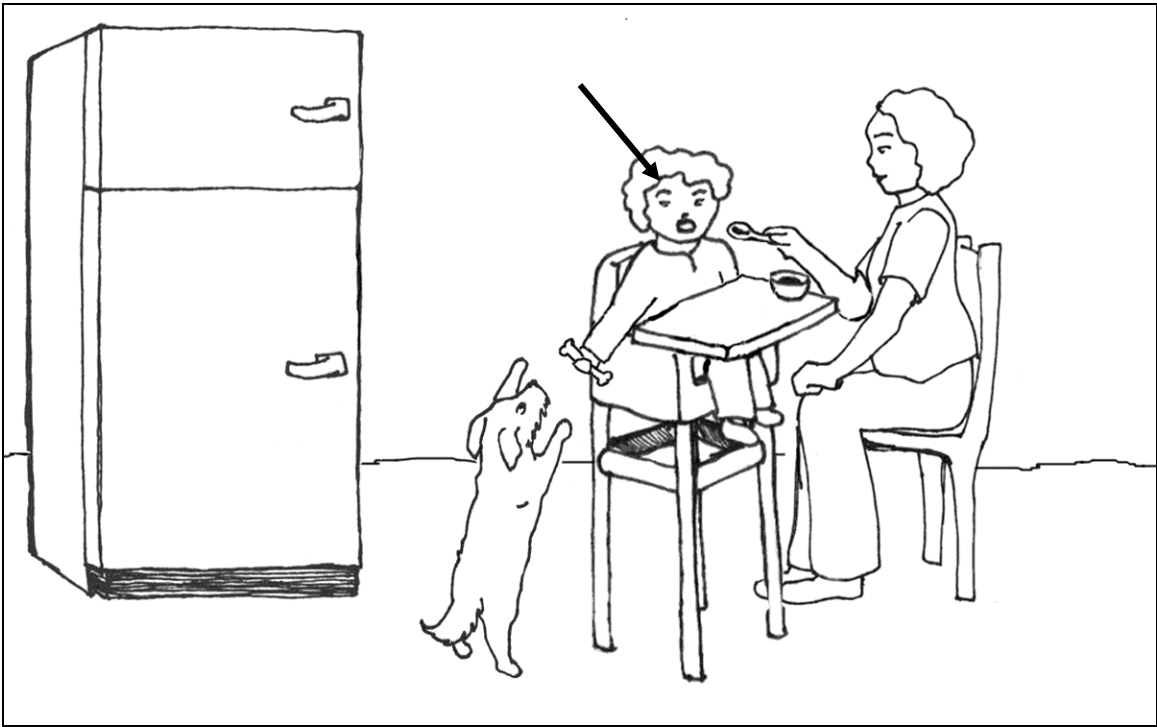

Problem 9-2a

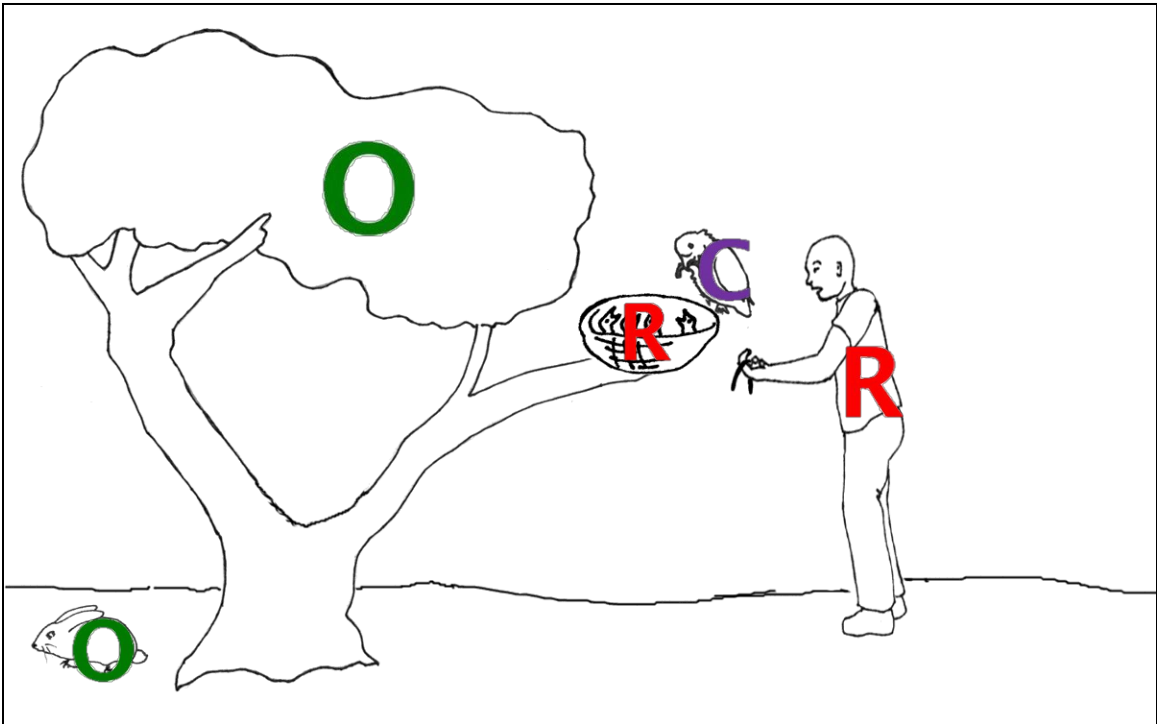
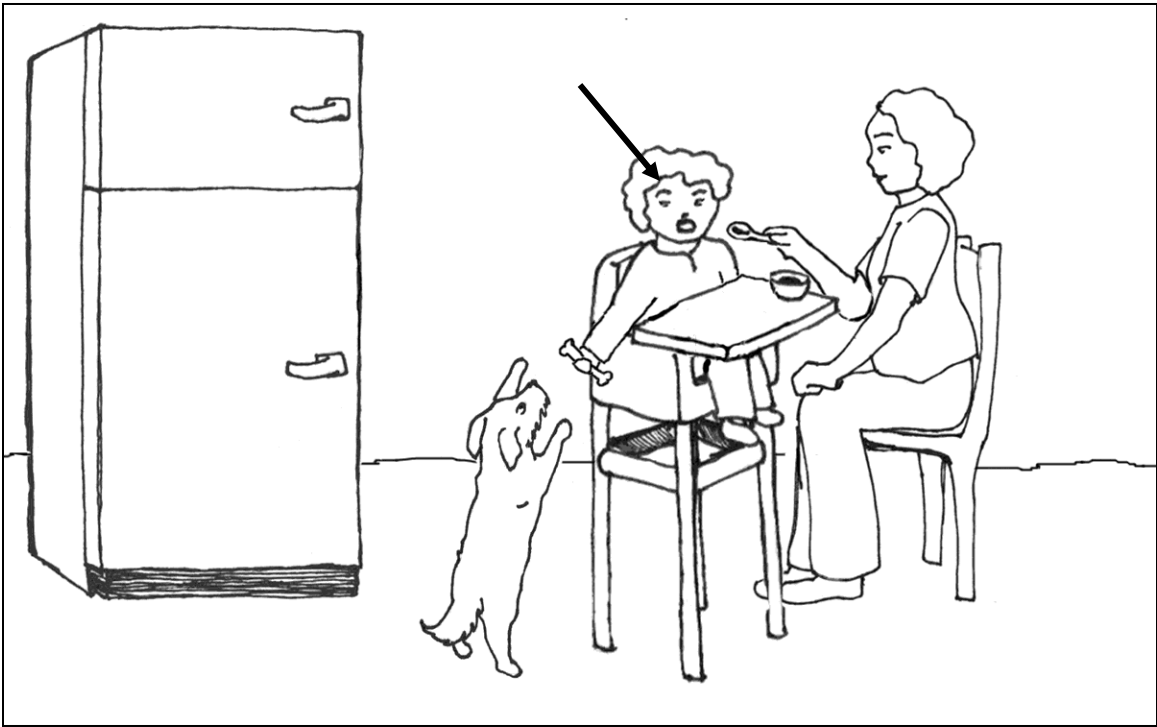

Problem 9-2b

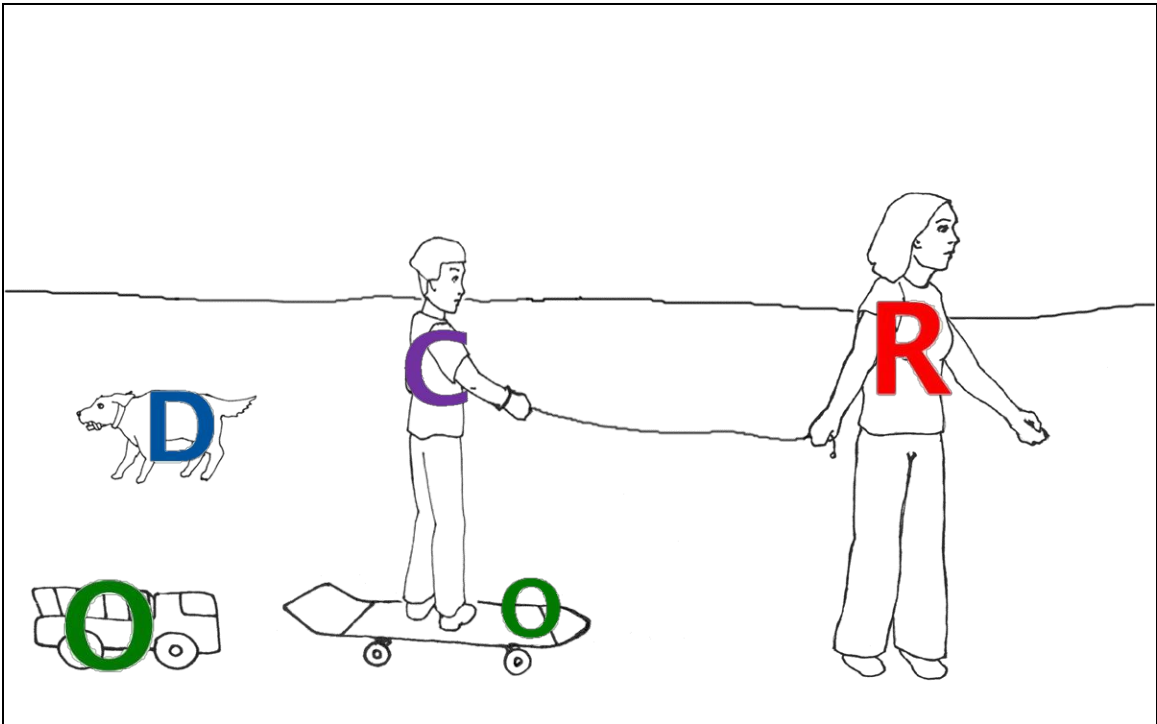
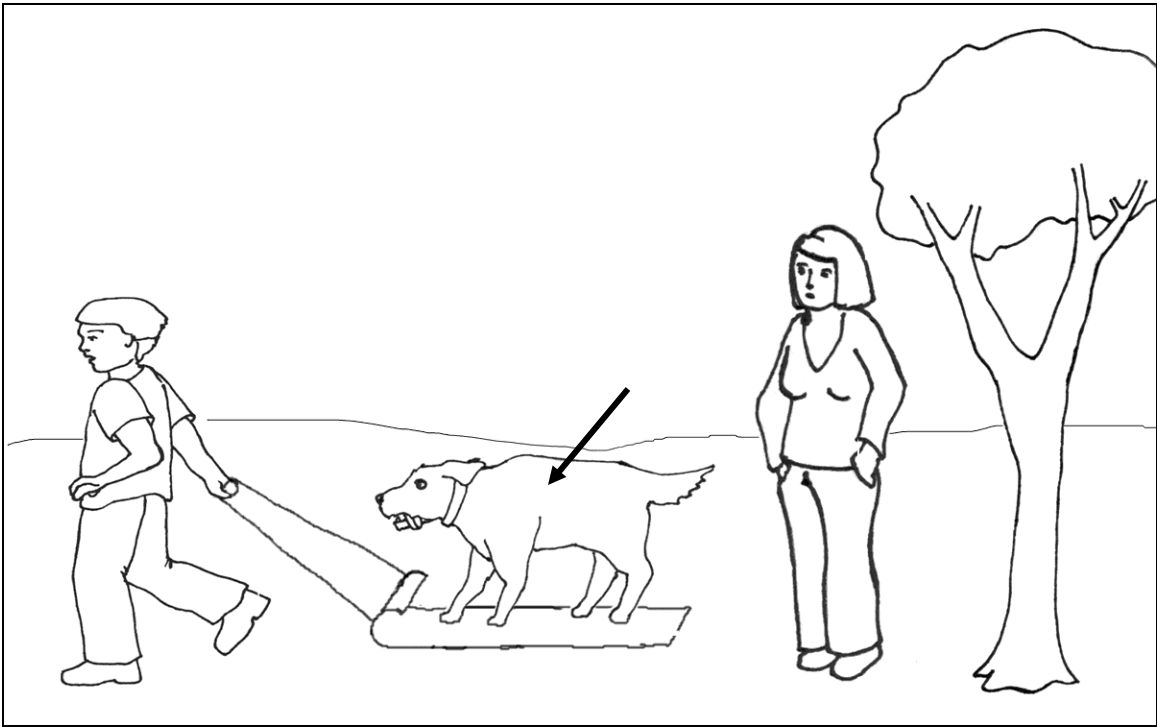

Problem 10-1a

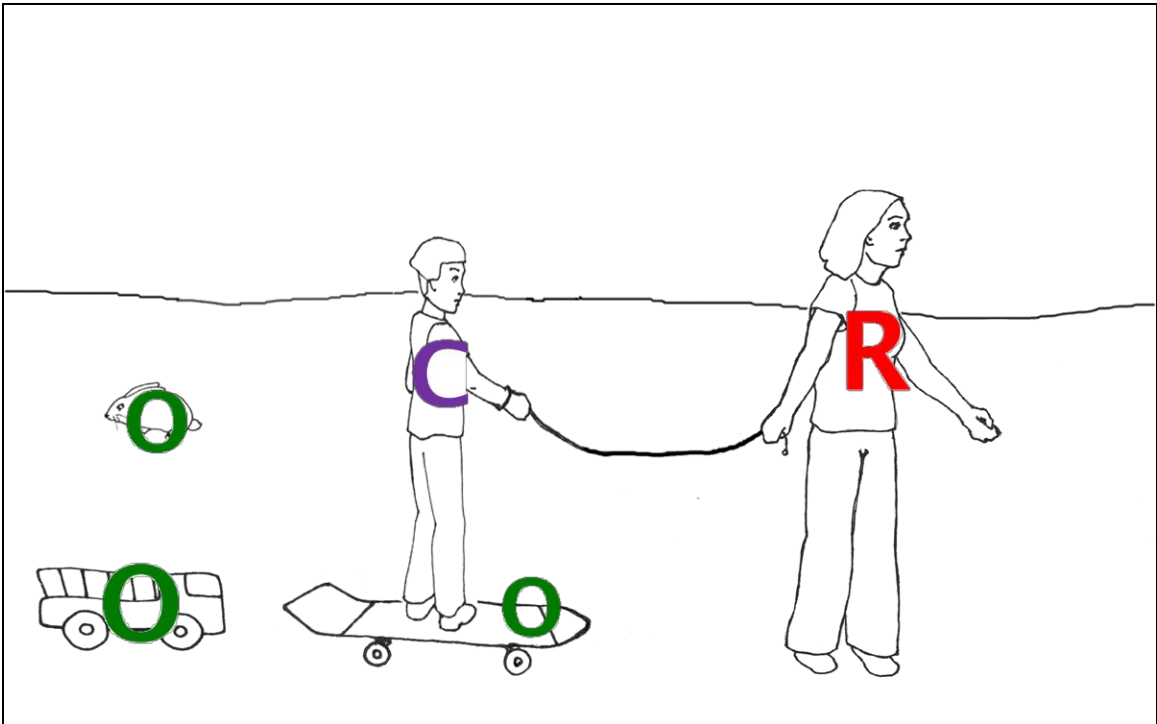
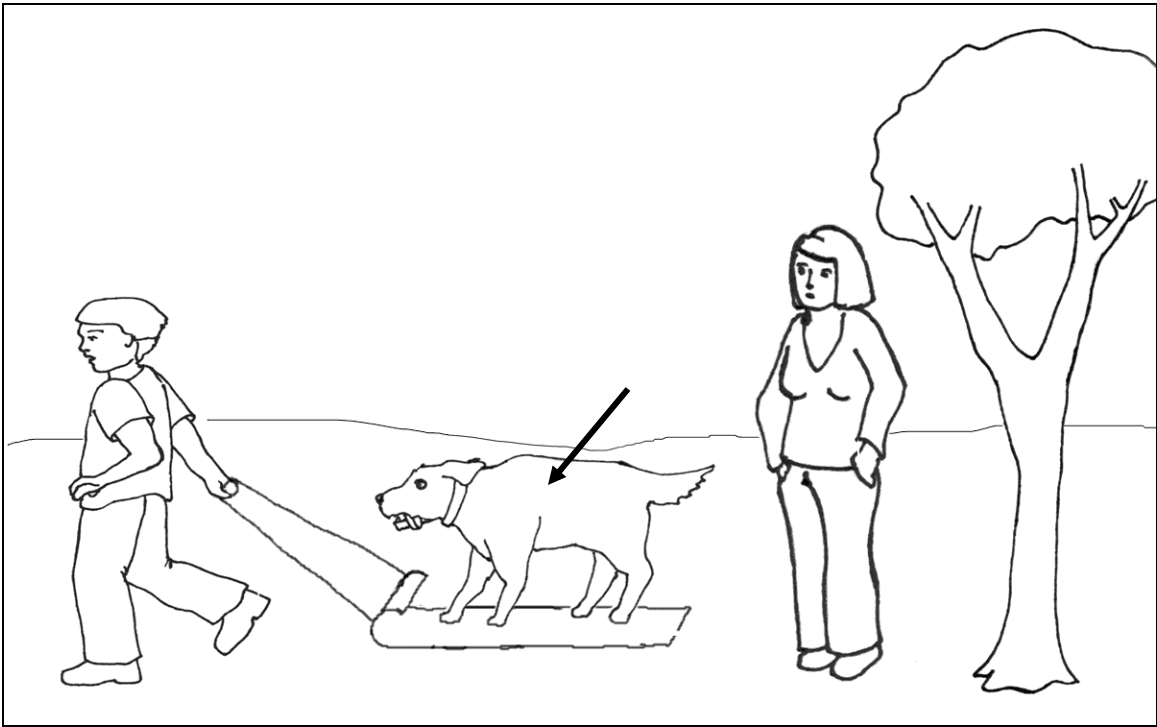

Problem 10-1b

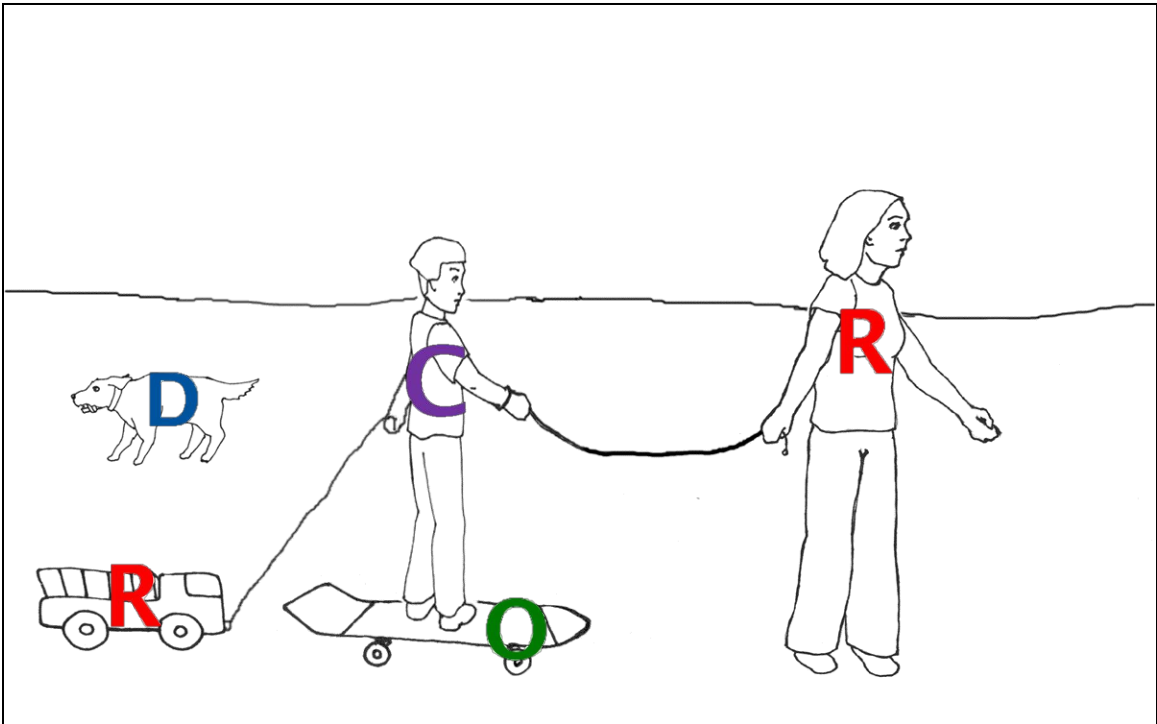
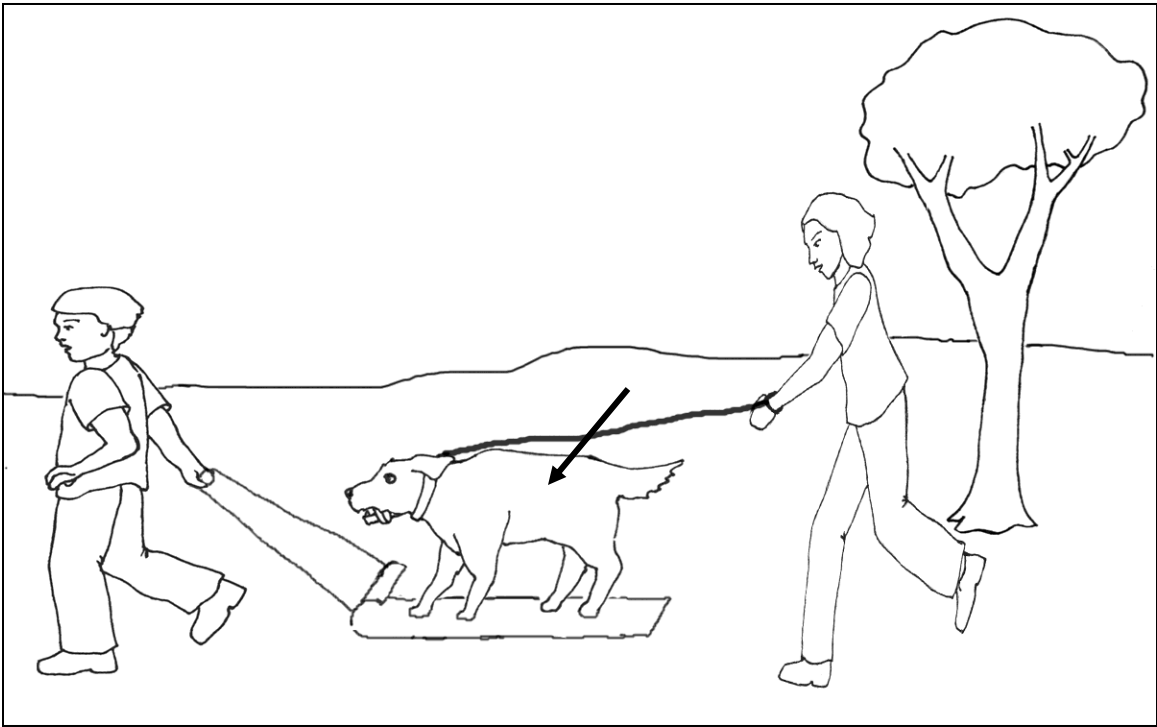

Problem 10-
2a

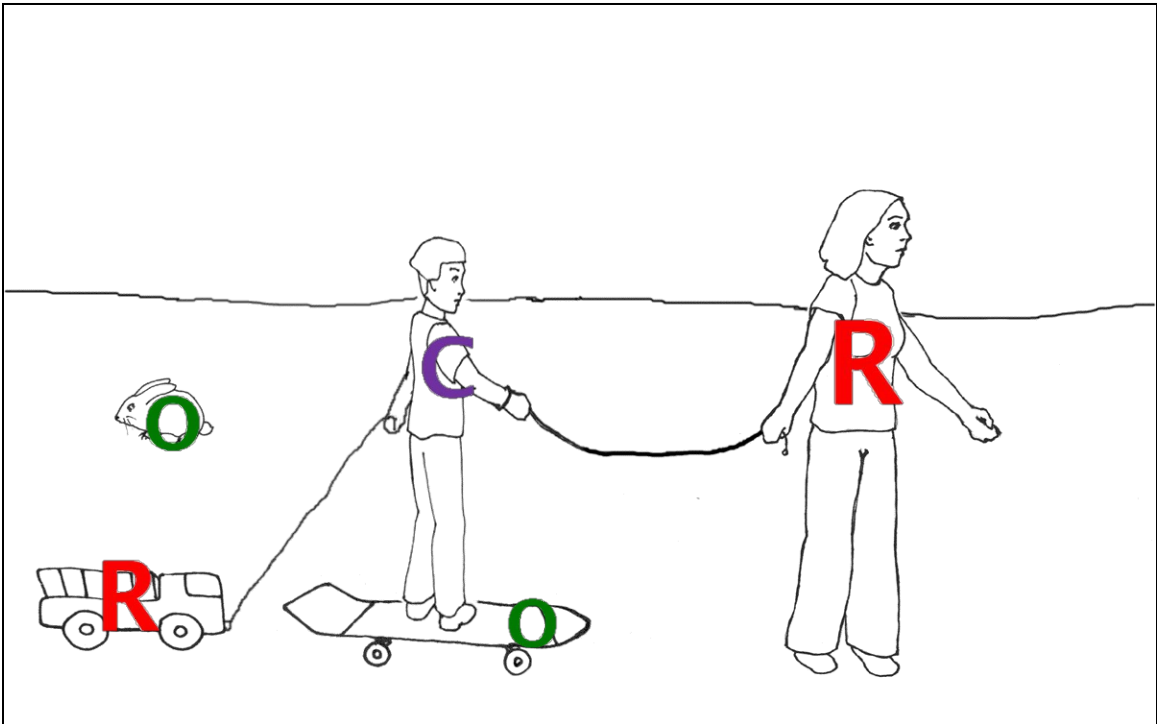
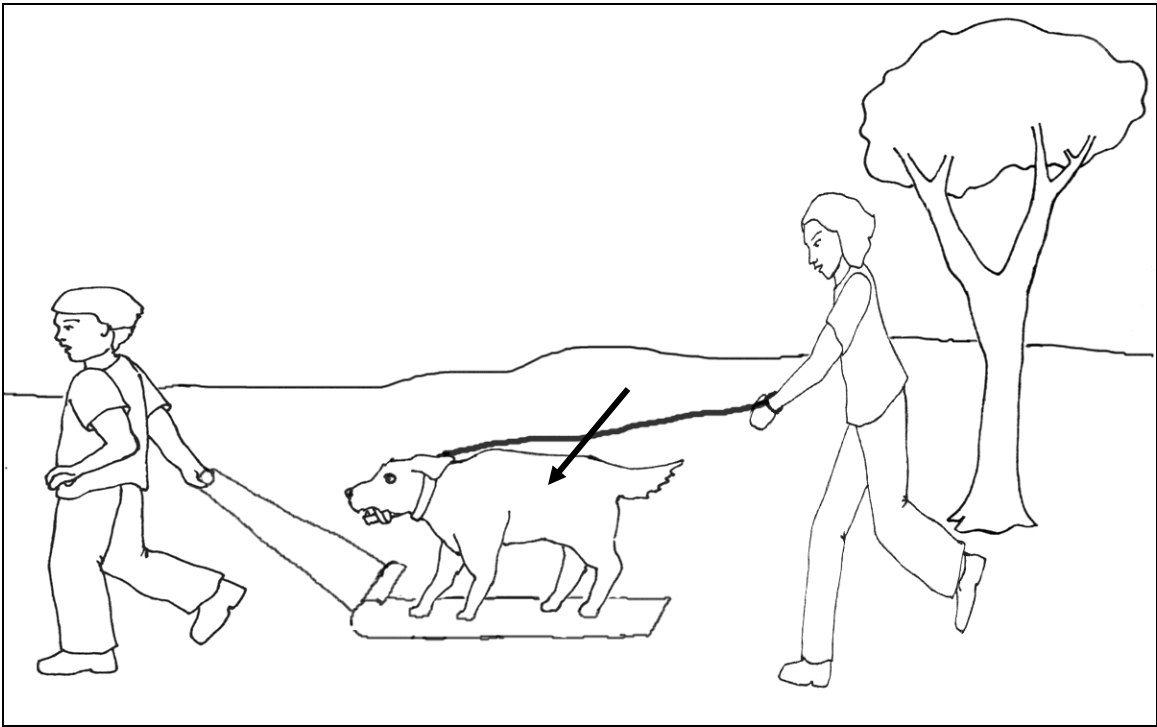

Problem 10-
2b

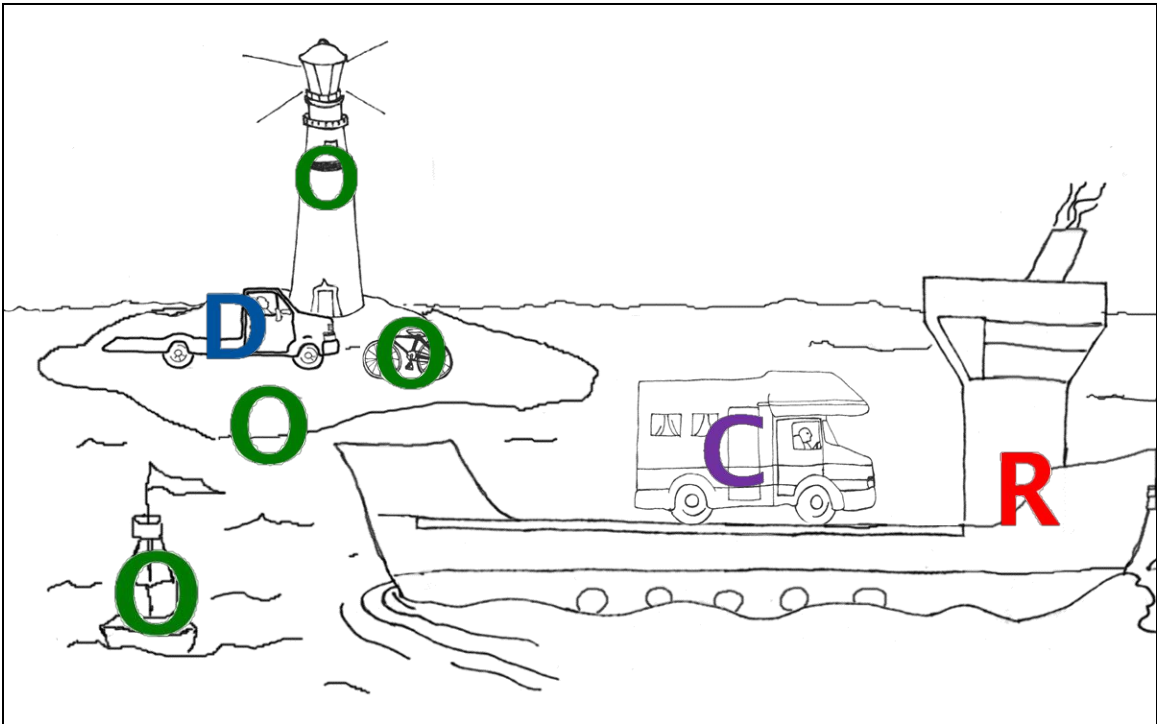
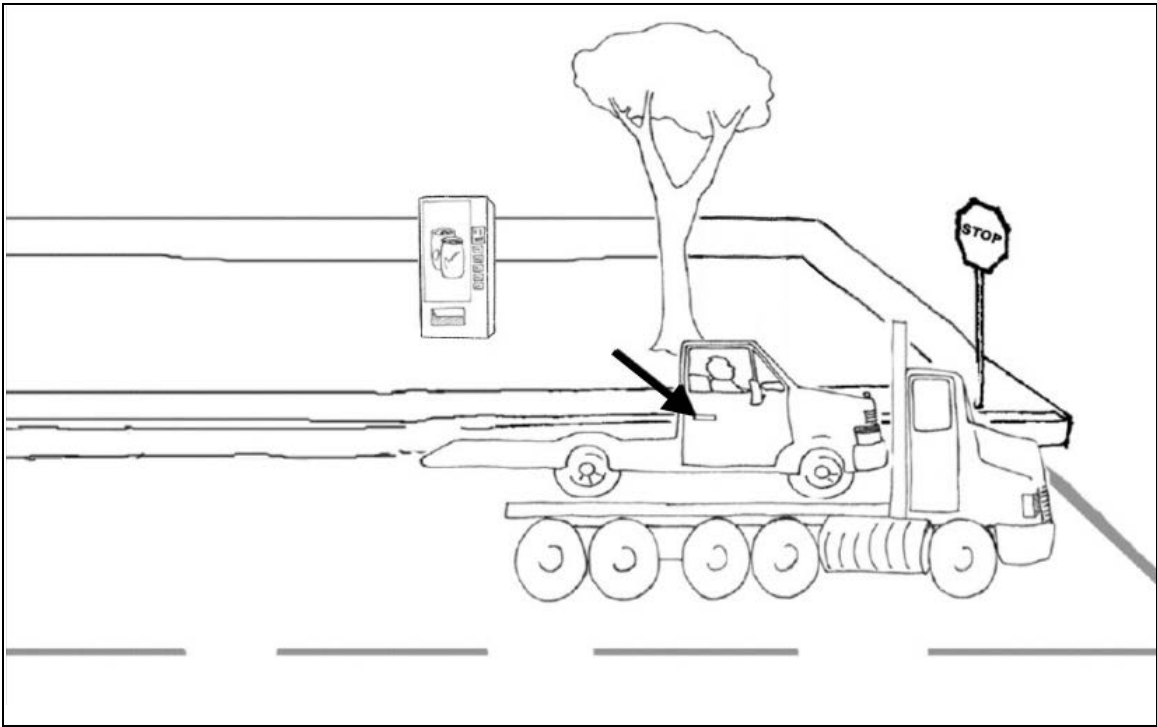

Problem 11-
1a

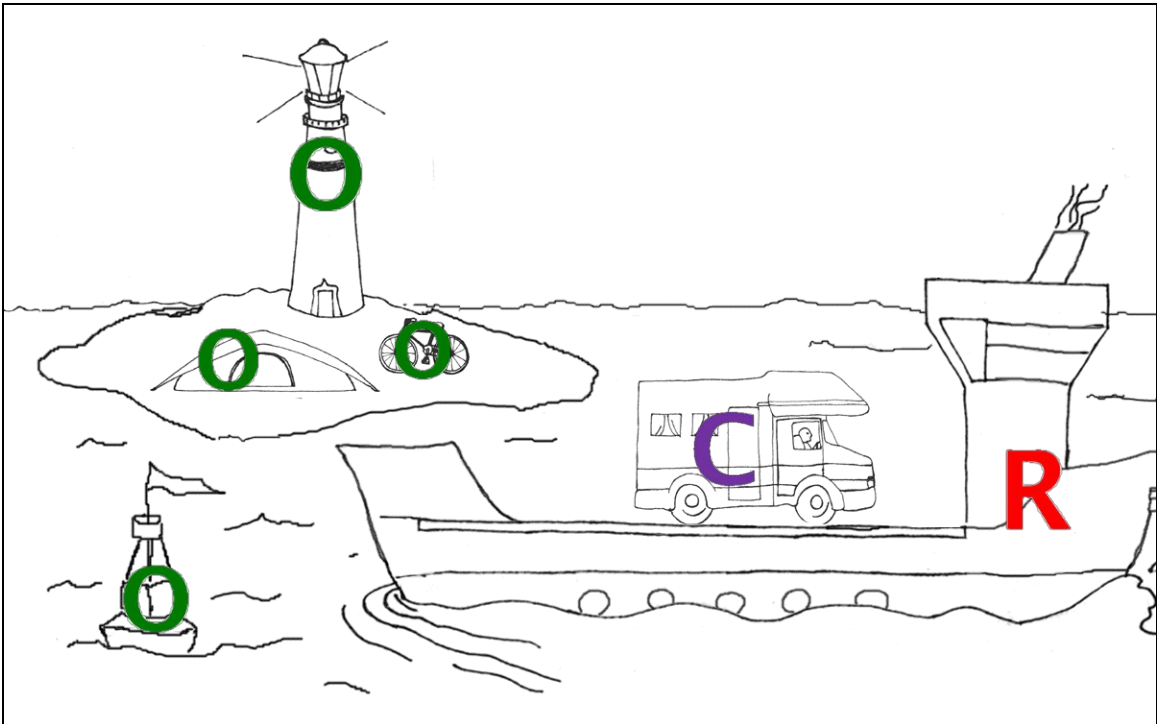
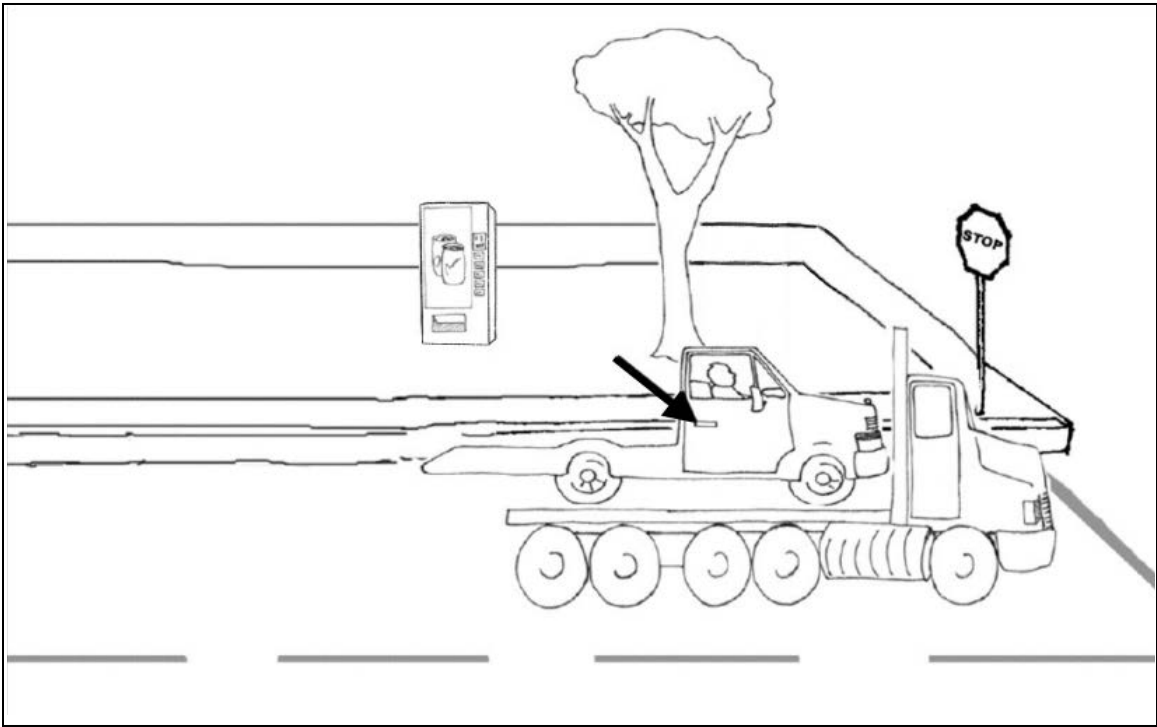

Problem 11-
1b

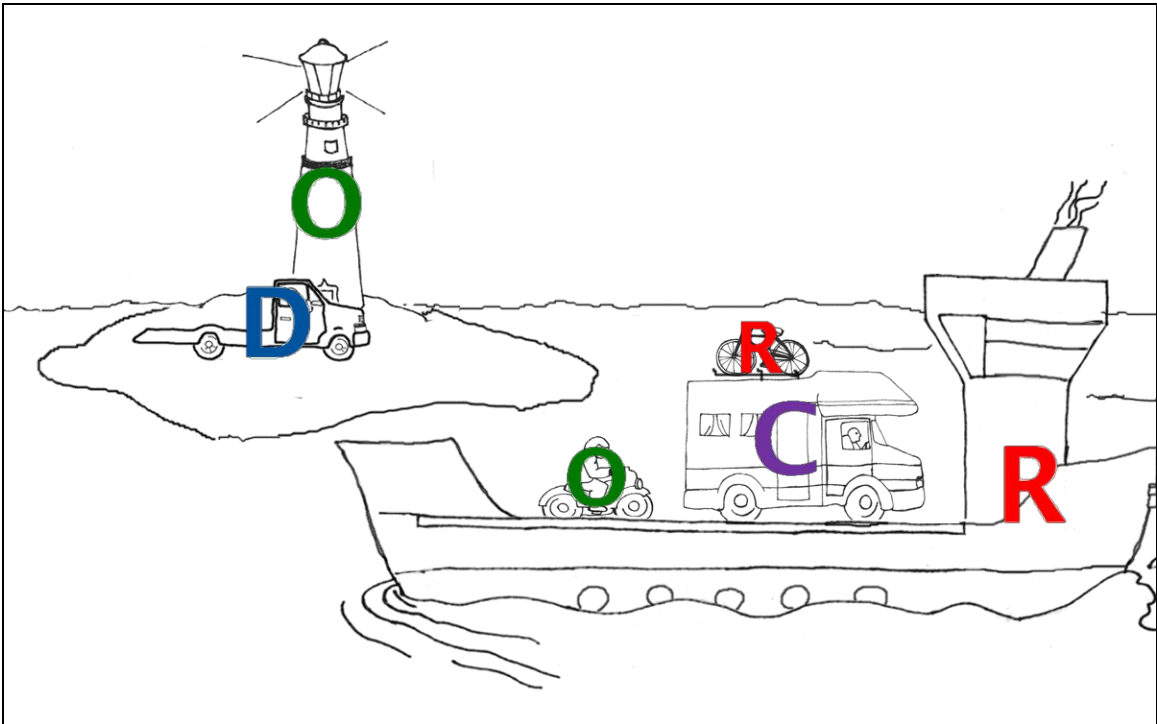
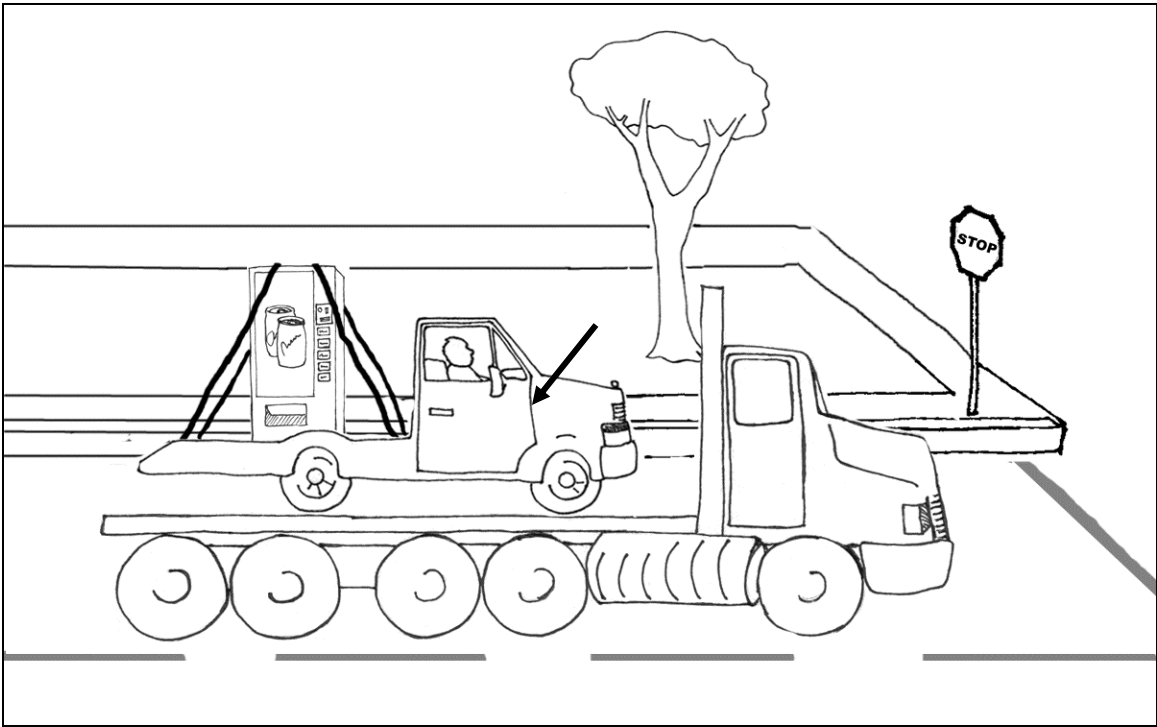

Problem 11-
2a

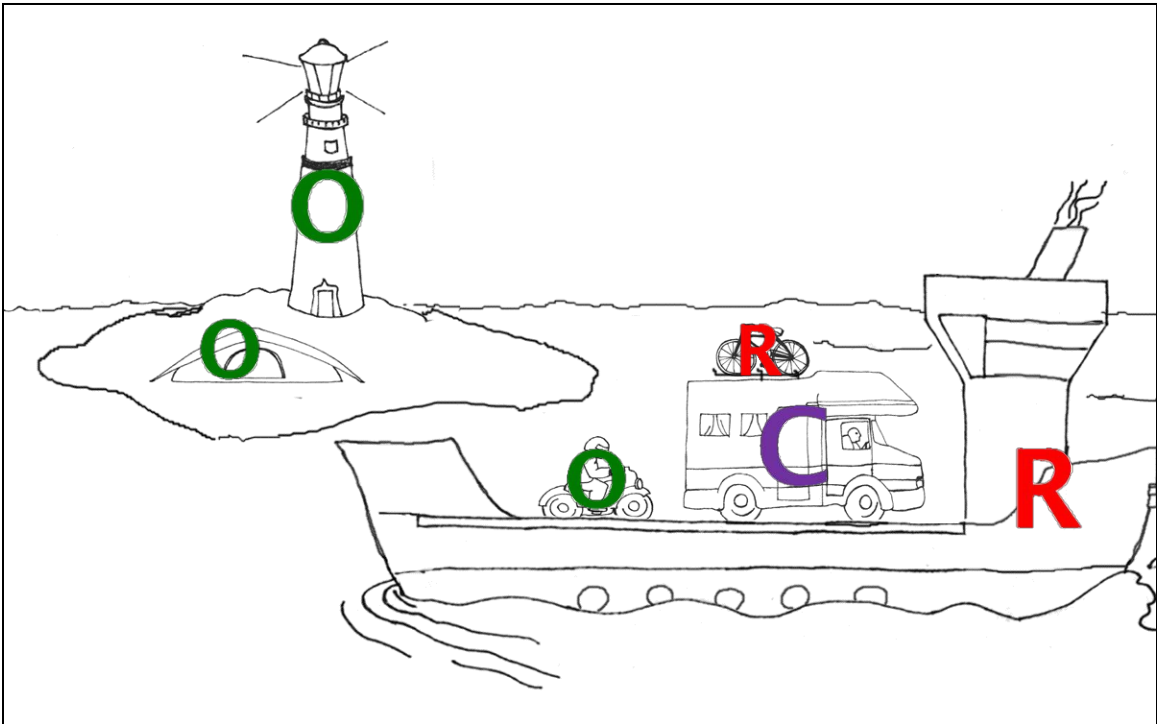
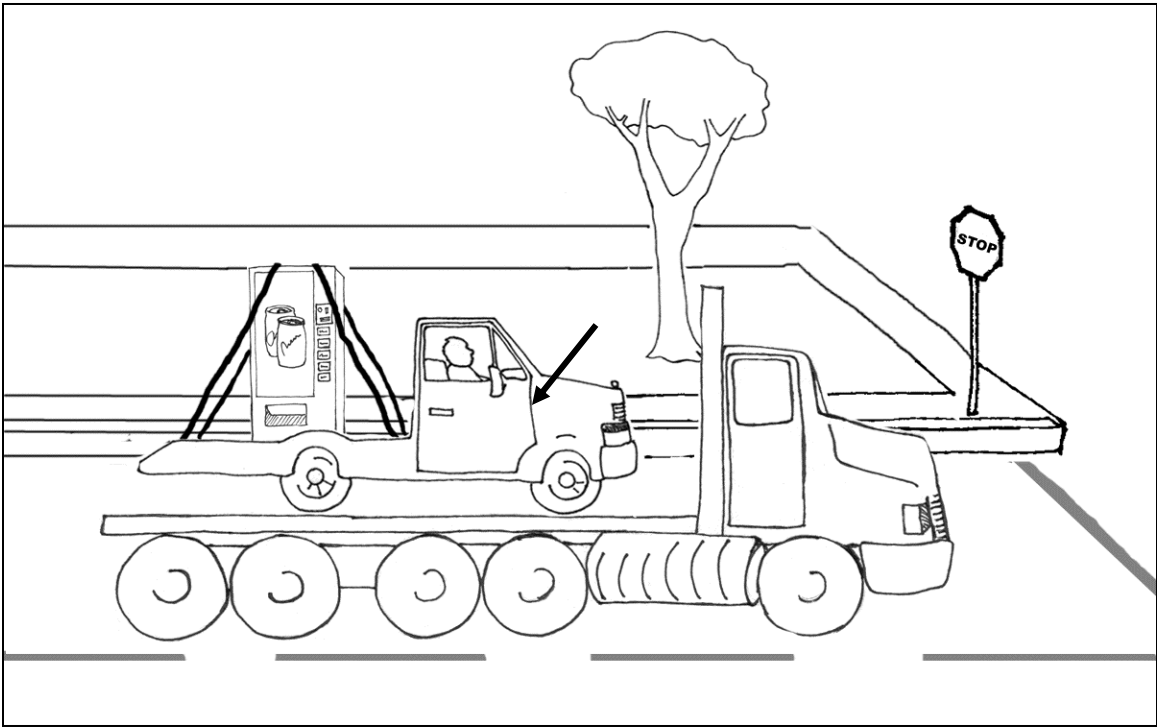

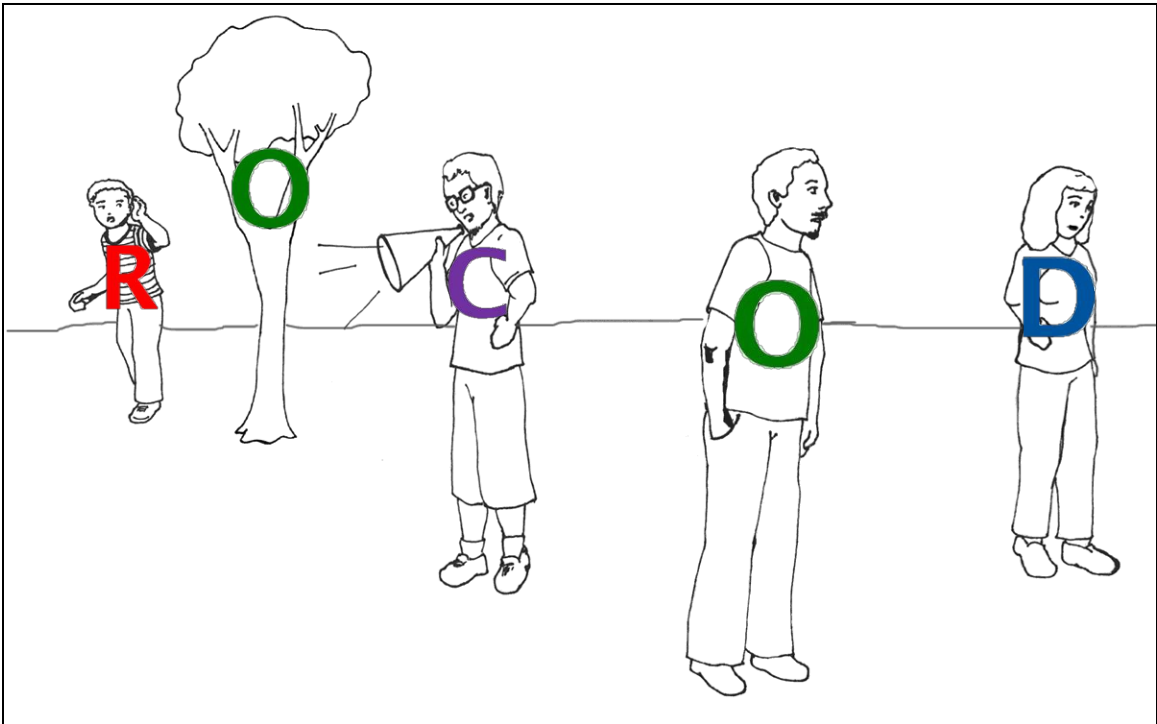

Problem 12-
1a

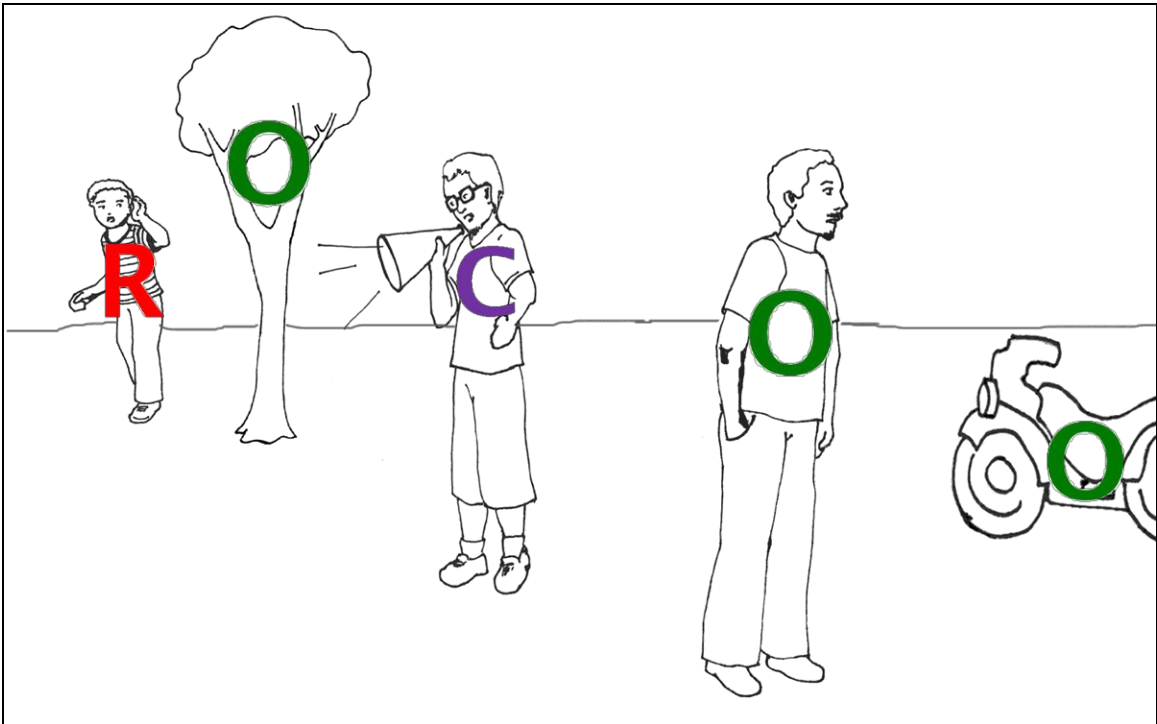

Problem 12-1b

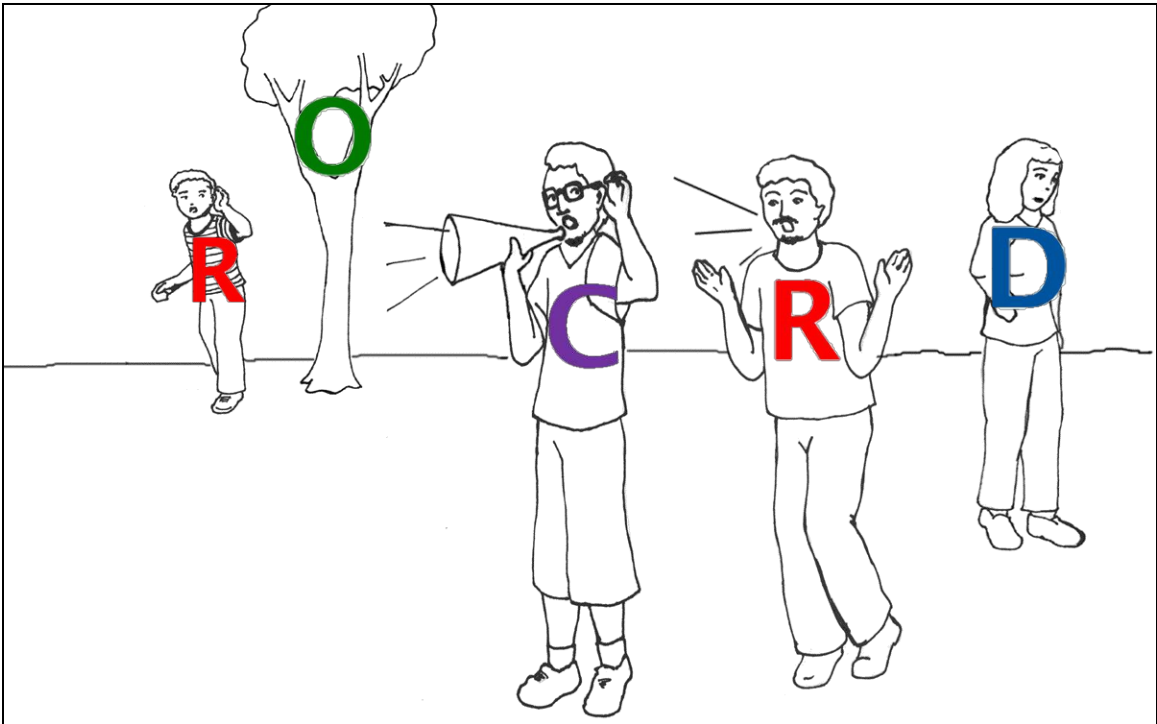

Problem 12-2a

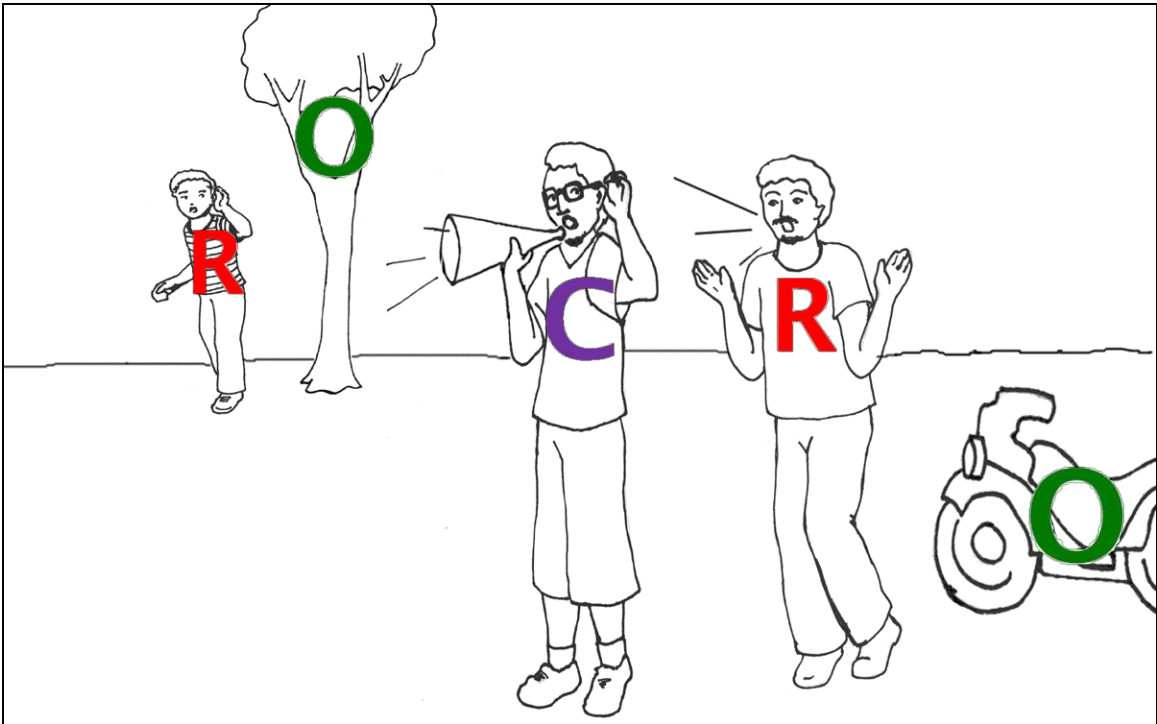

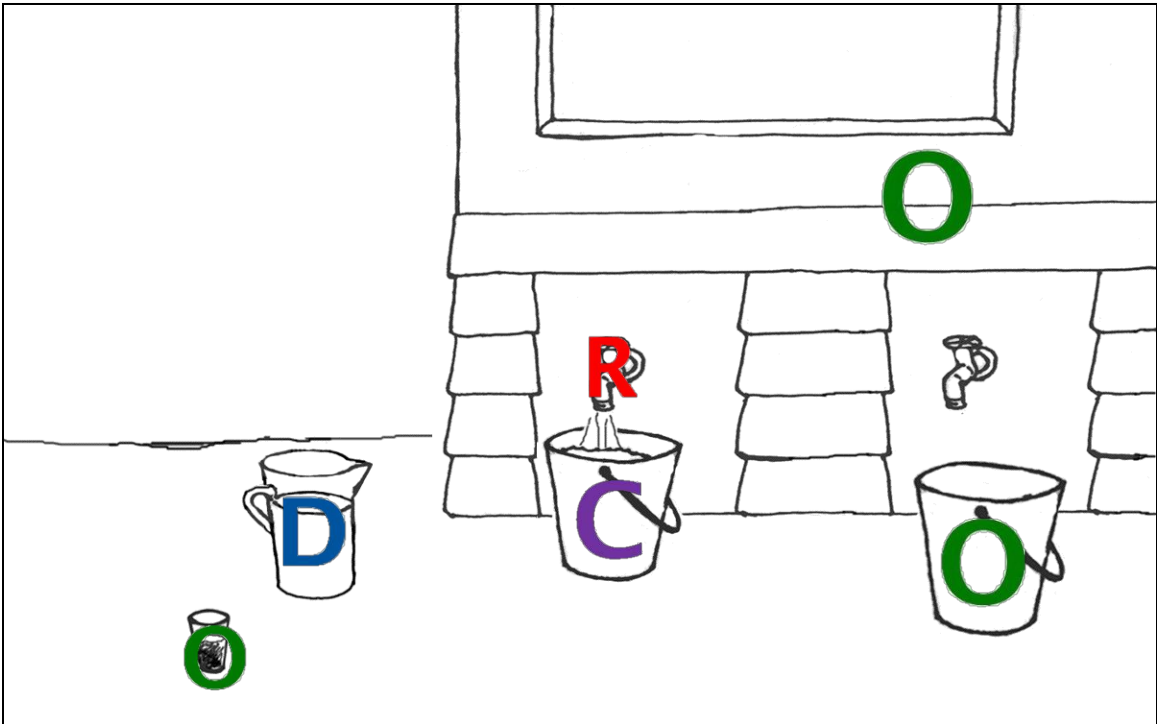
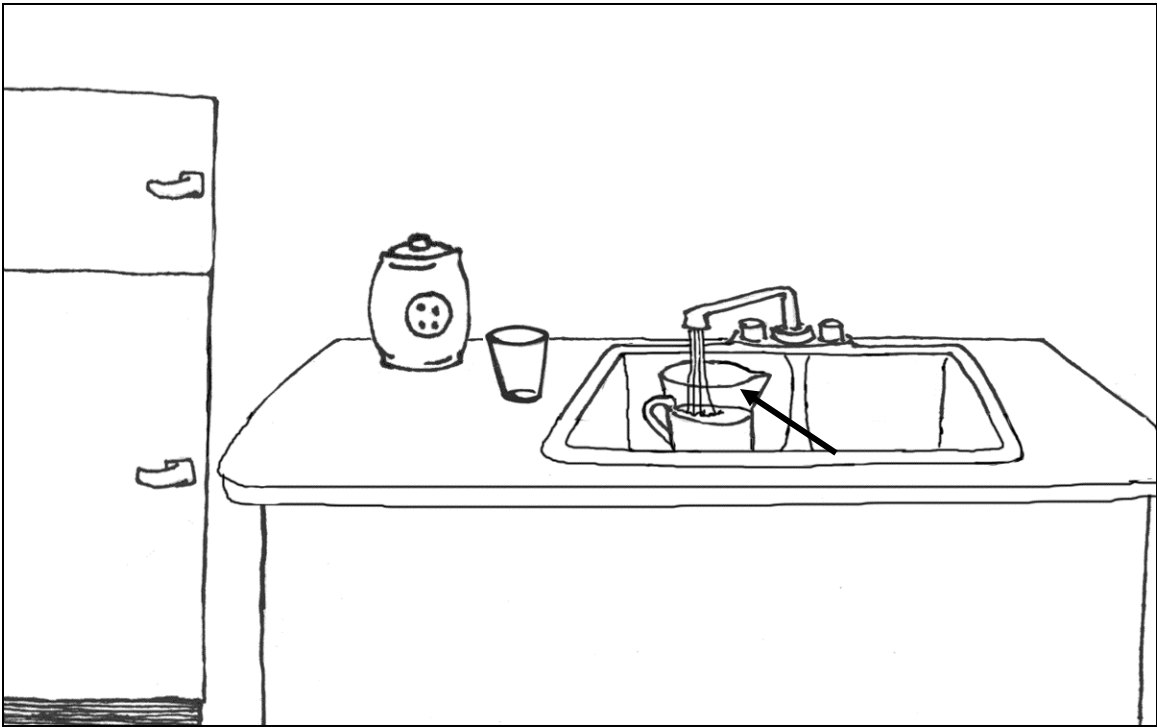

Problem 13-
1a

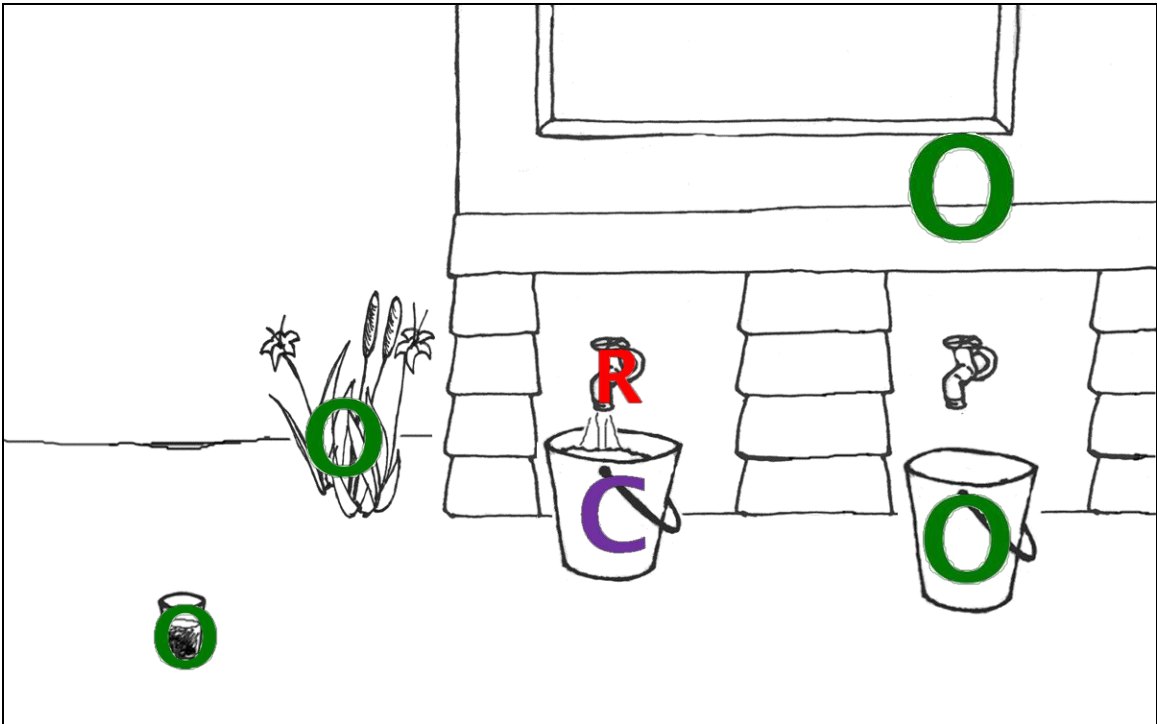
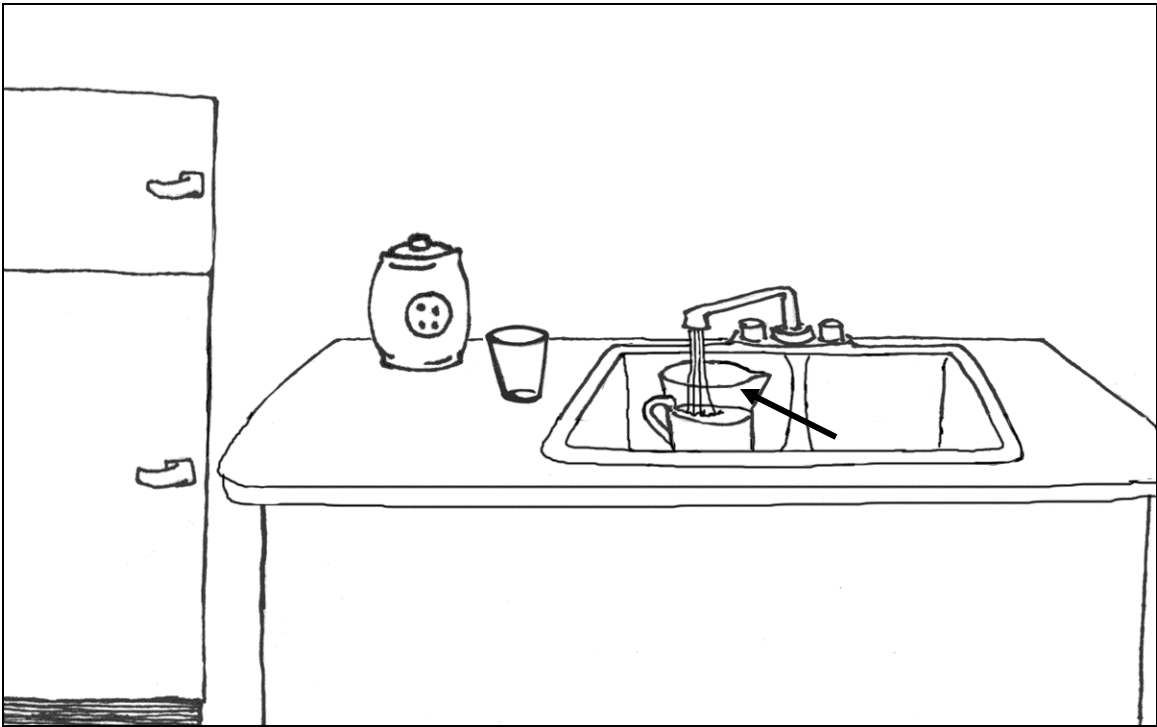

Problem 13-
1b

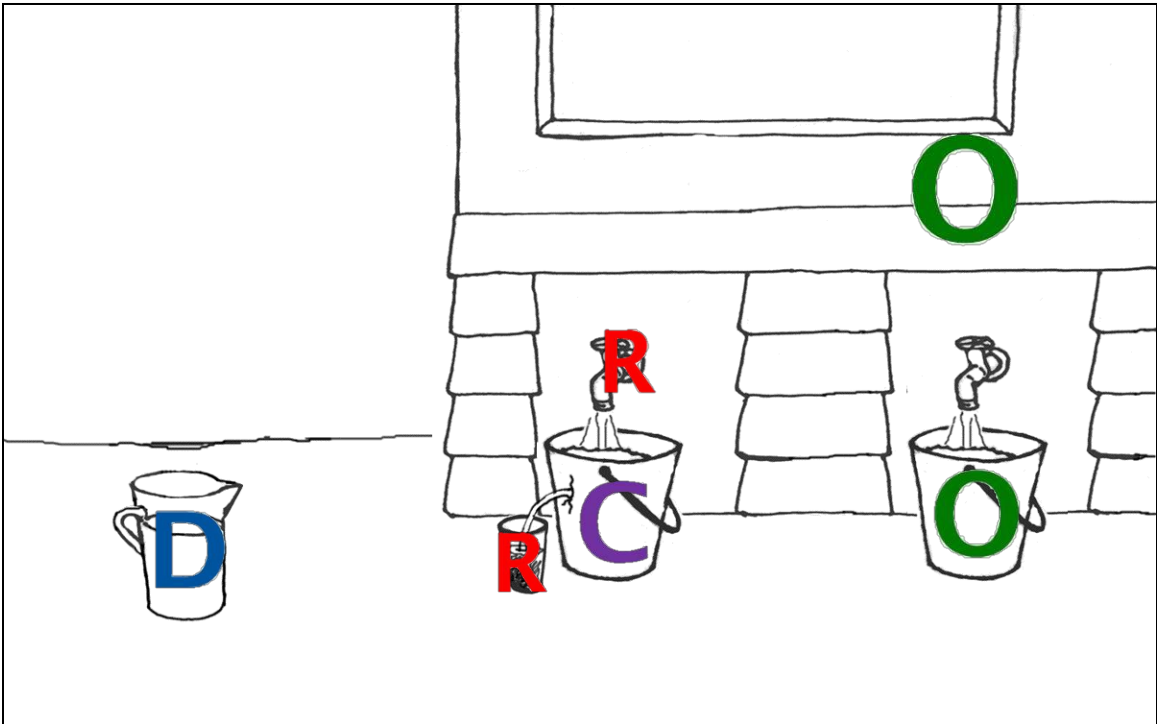
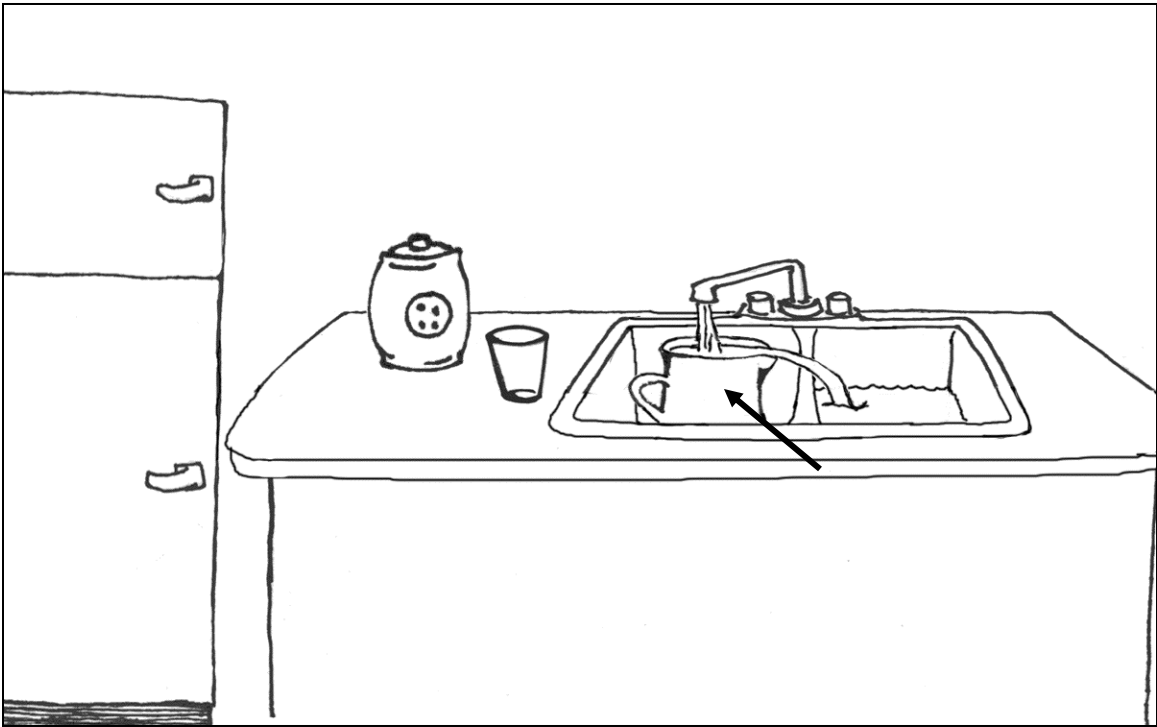

Problem 13-
2a

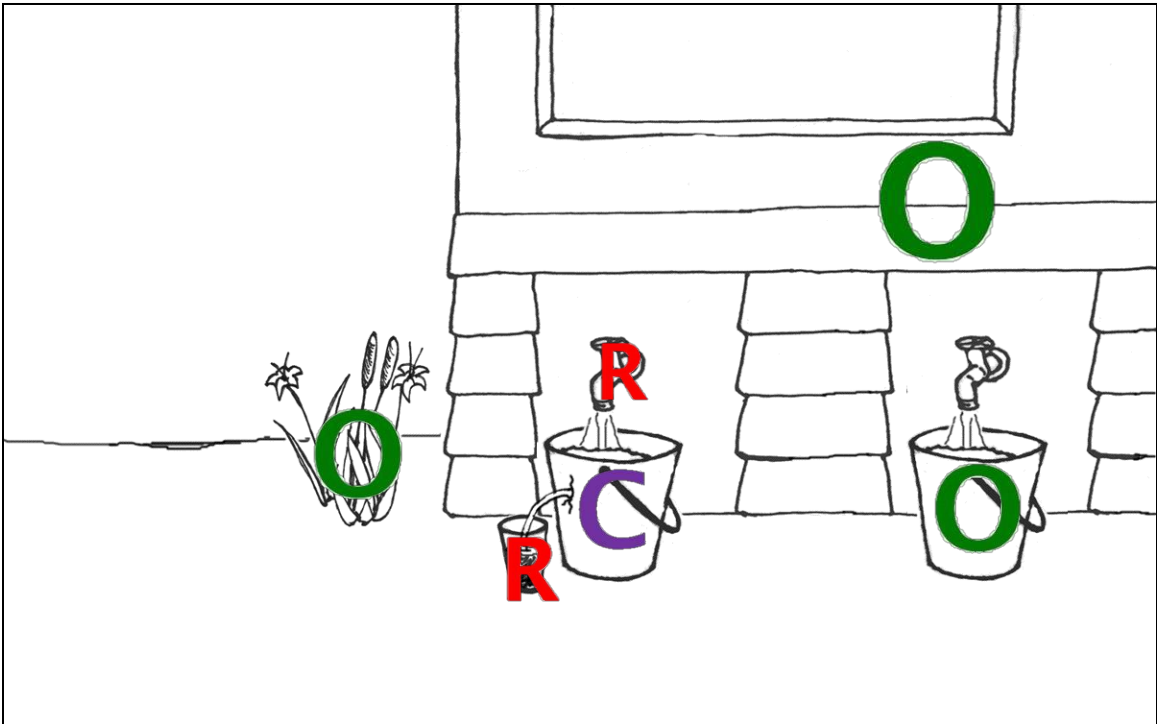
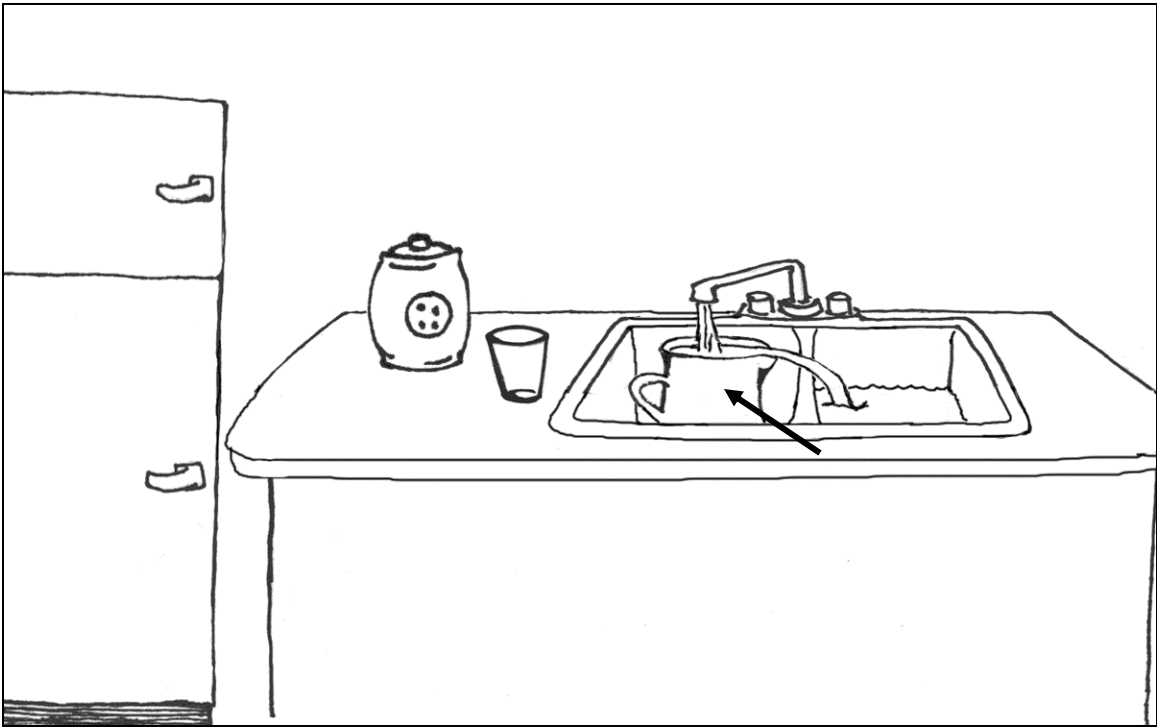

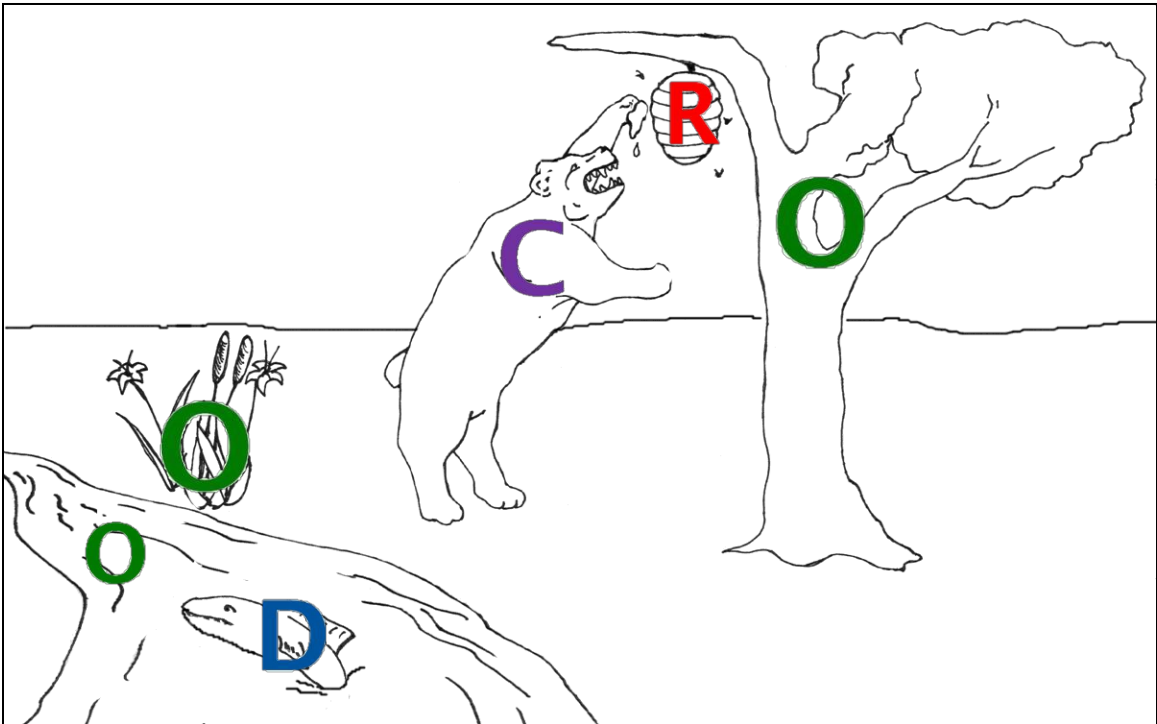
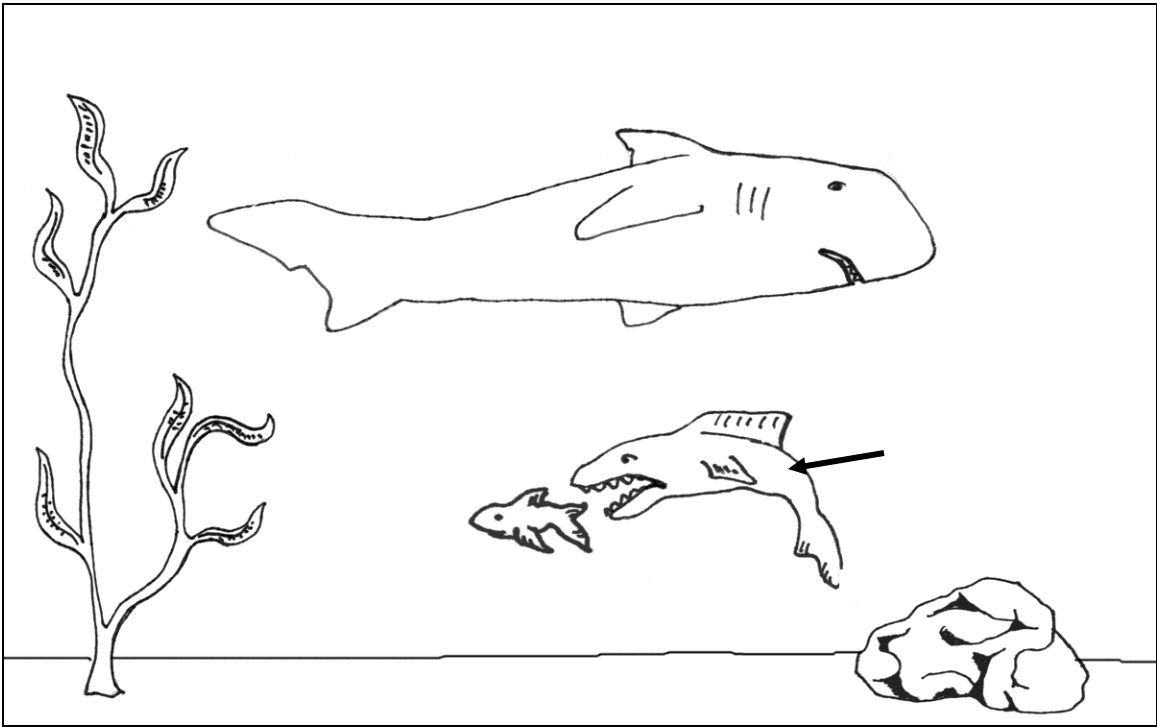

Problem 14-
1a

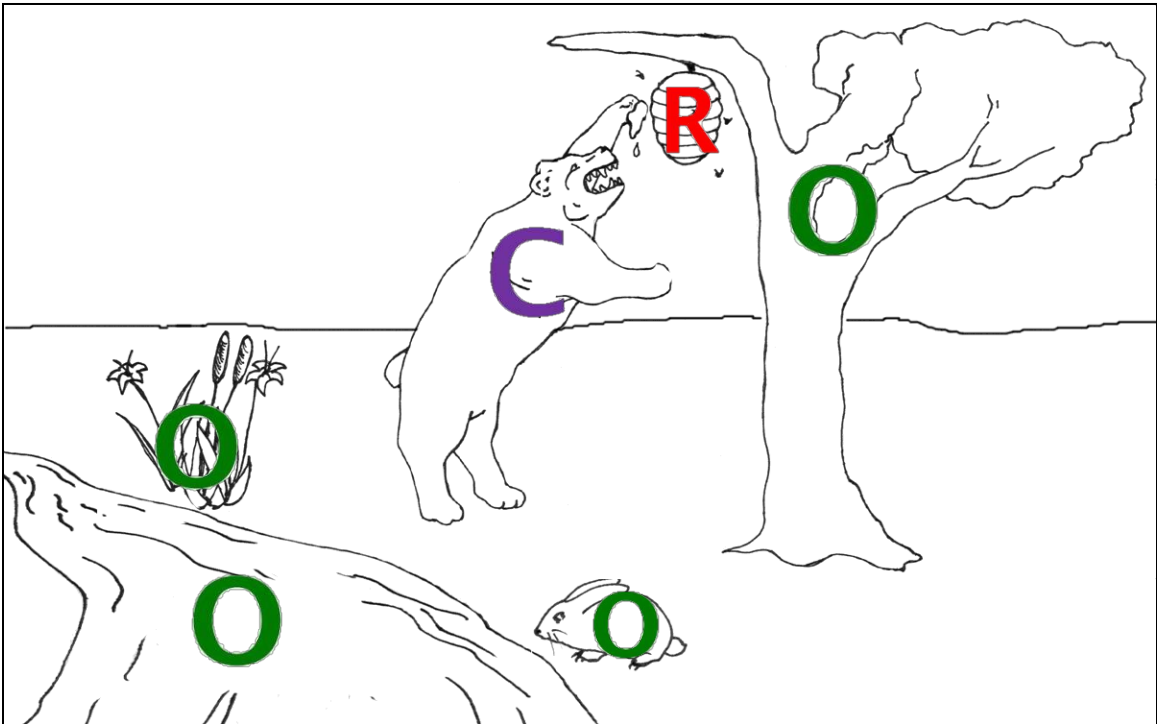
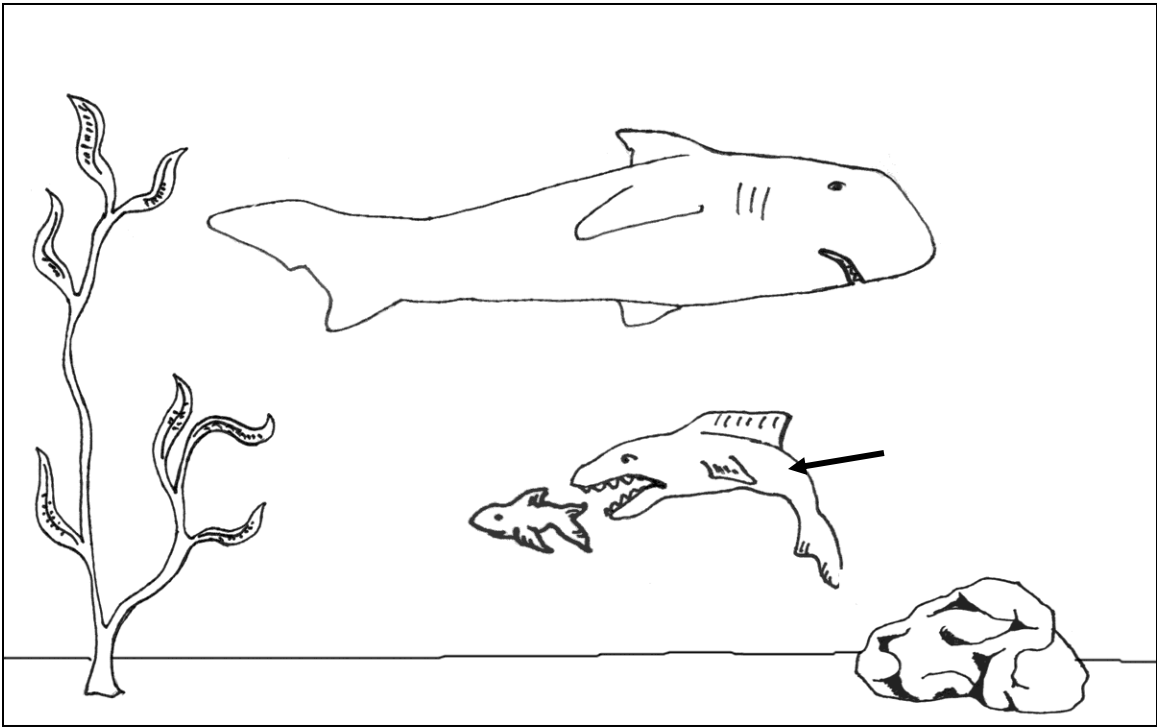

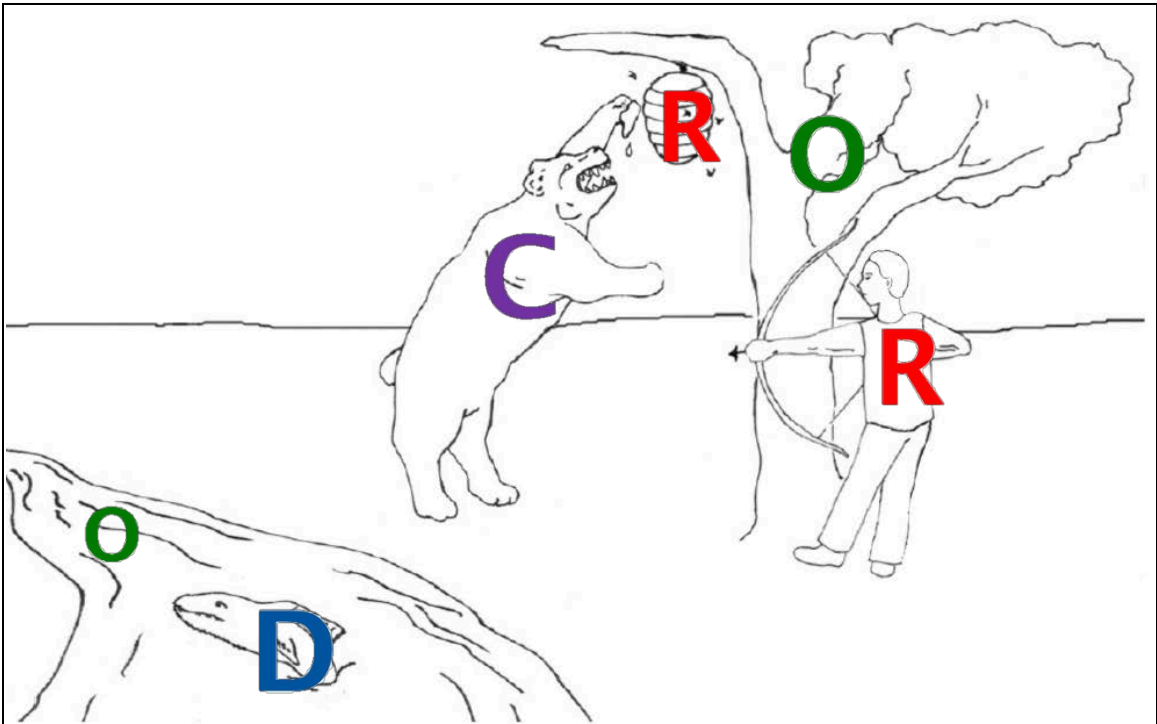
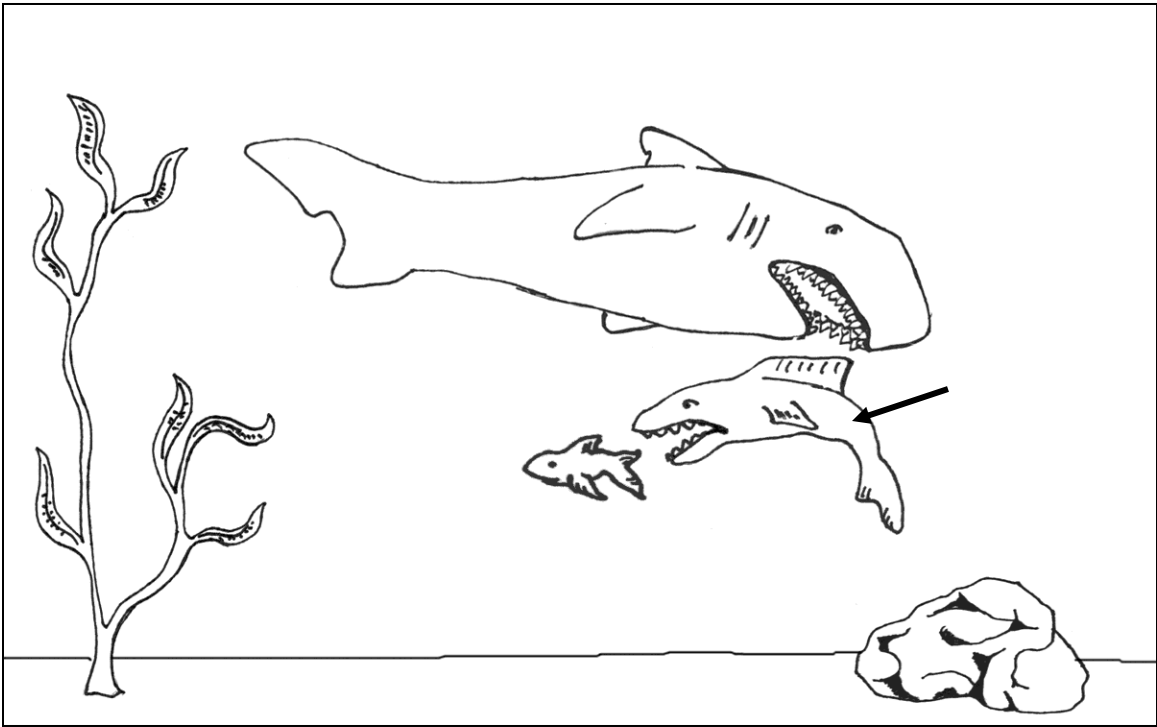

Problem 14-
2a

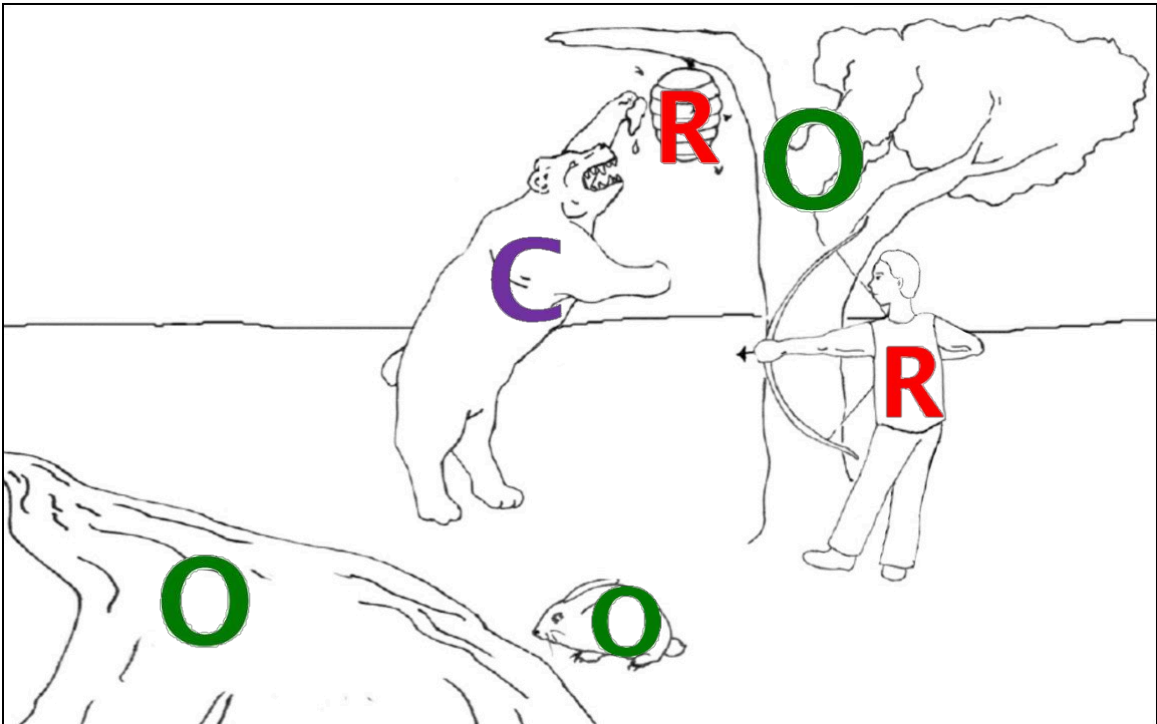
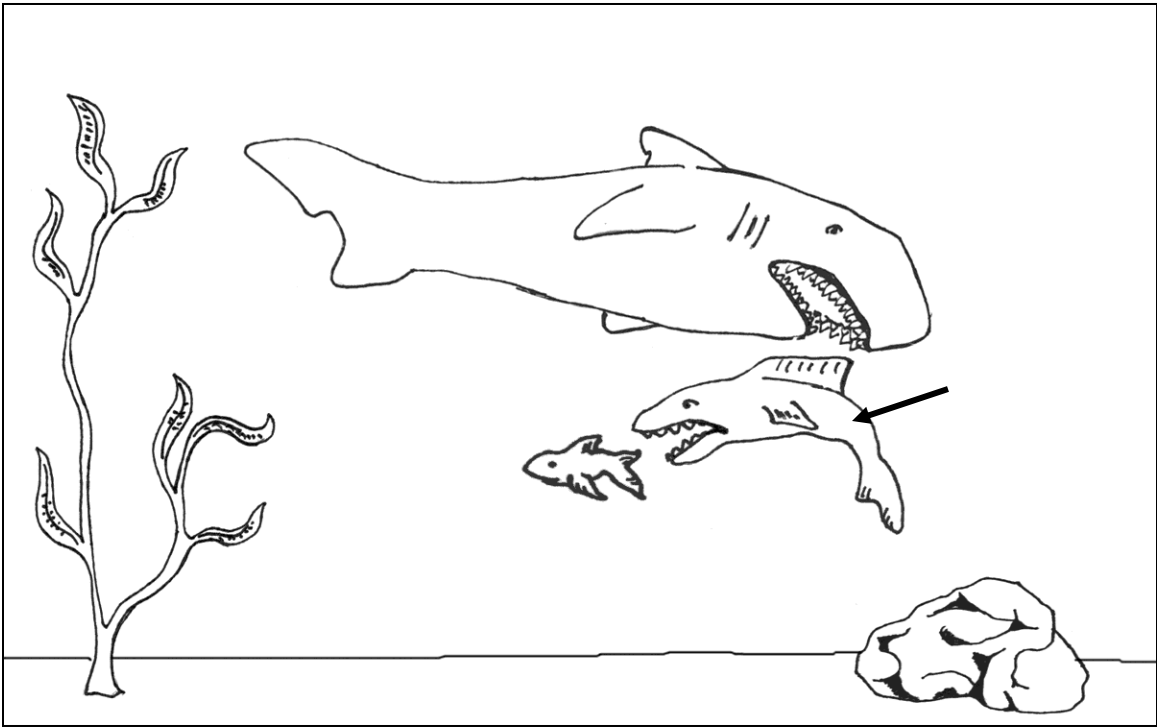

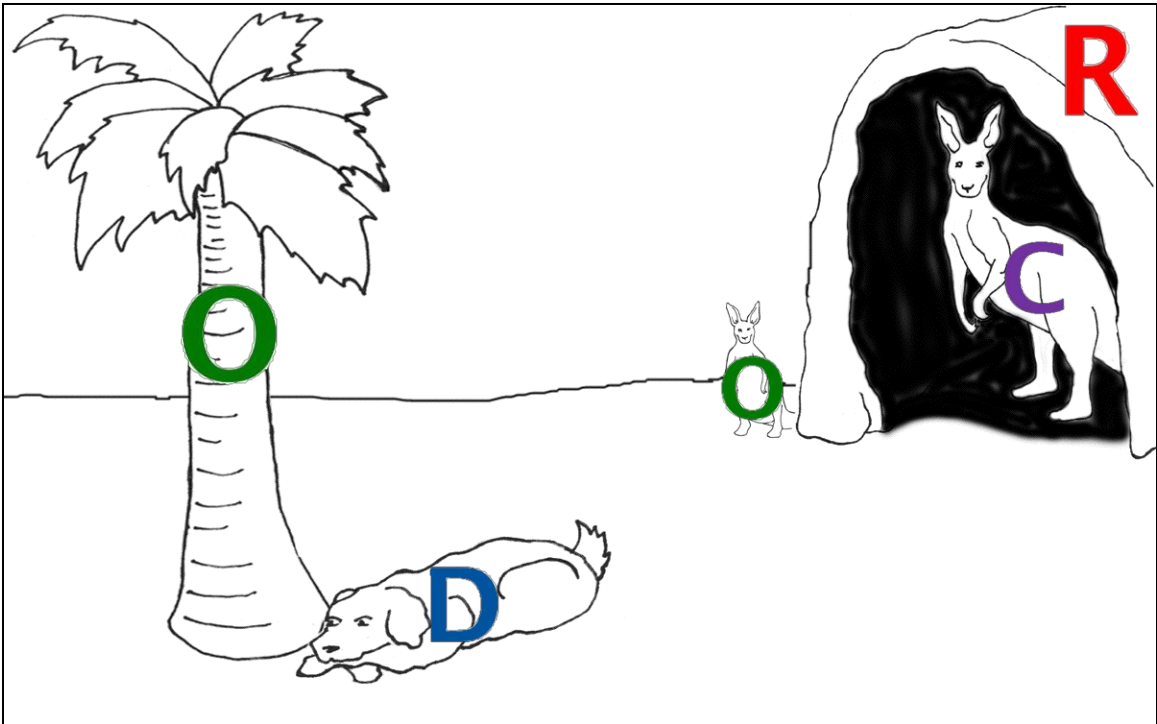
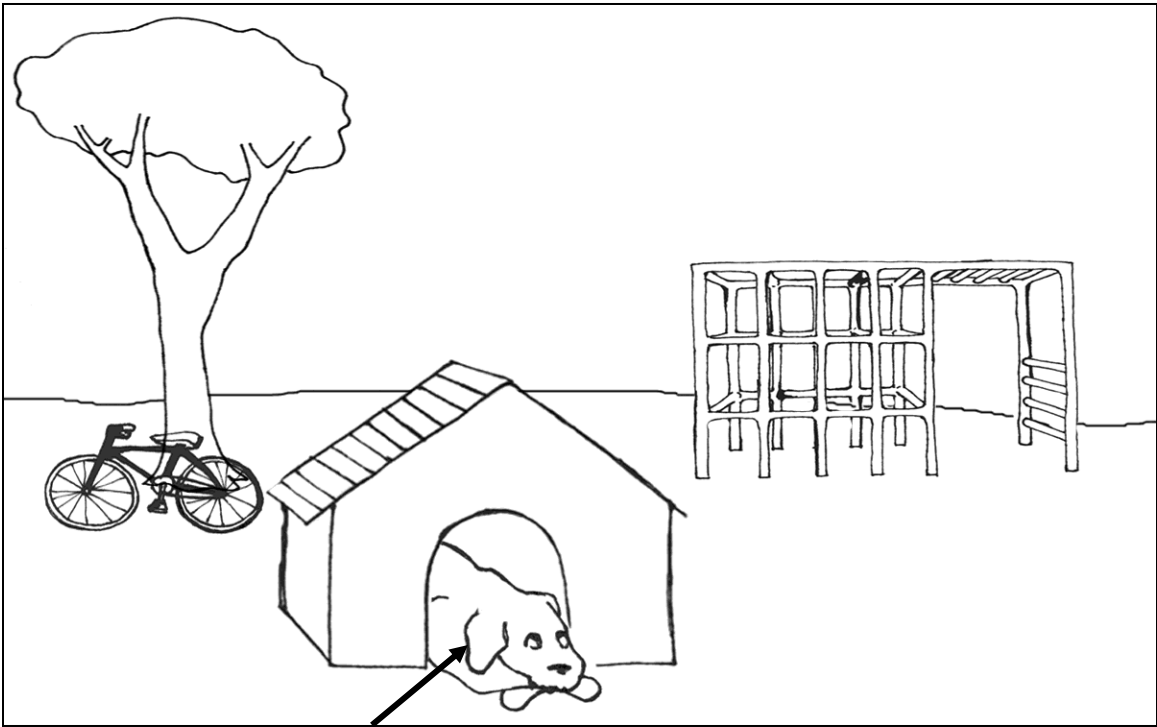

Problem 15-
1a

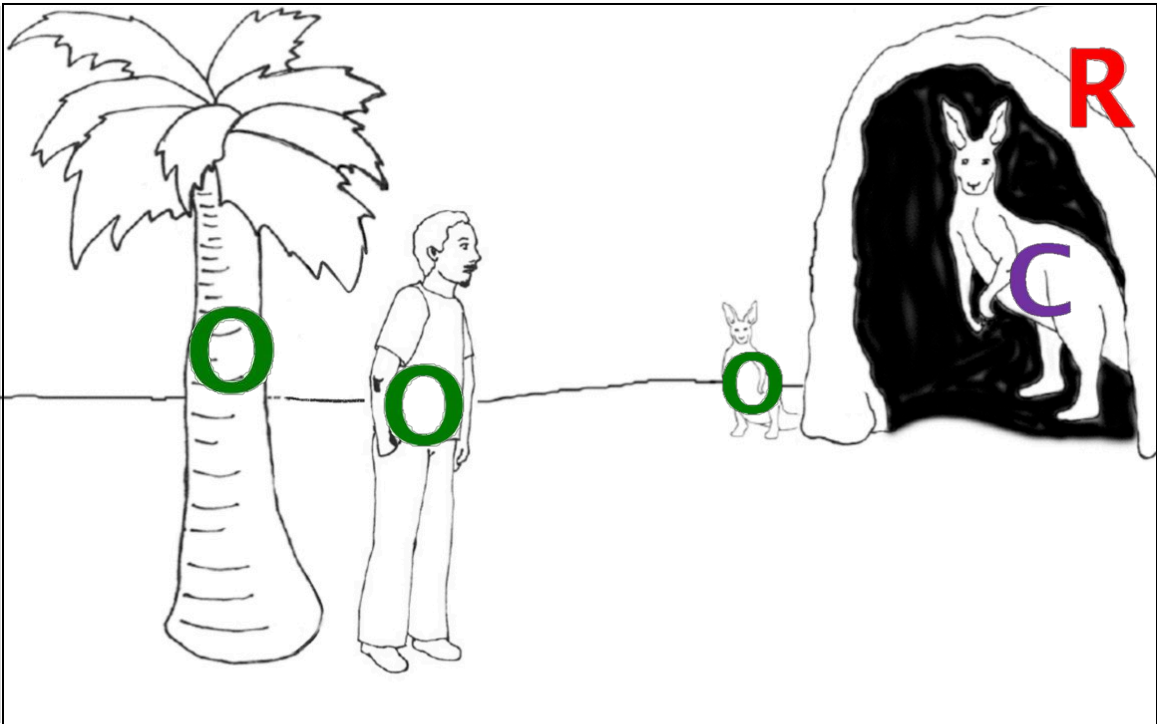
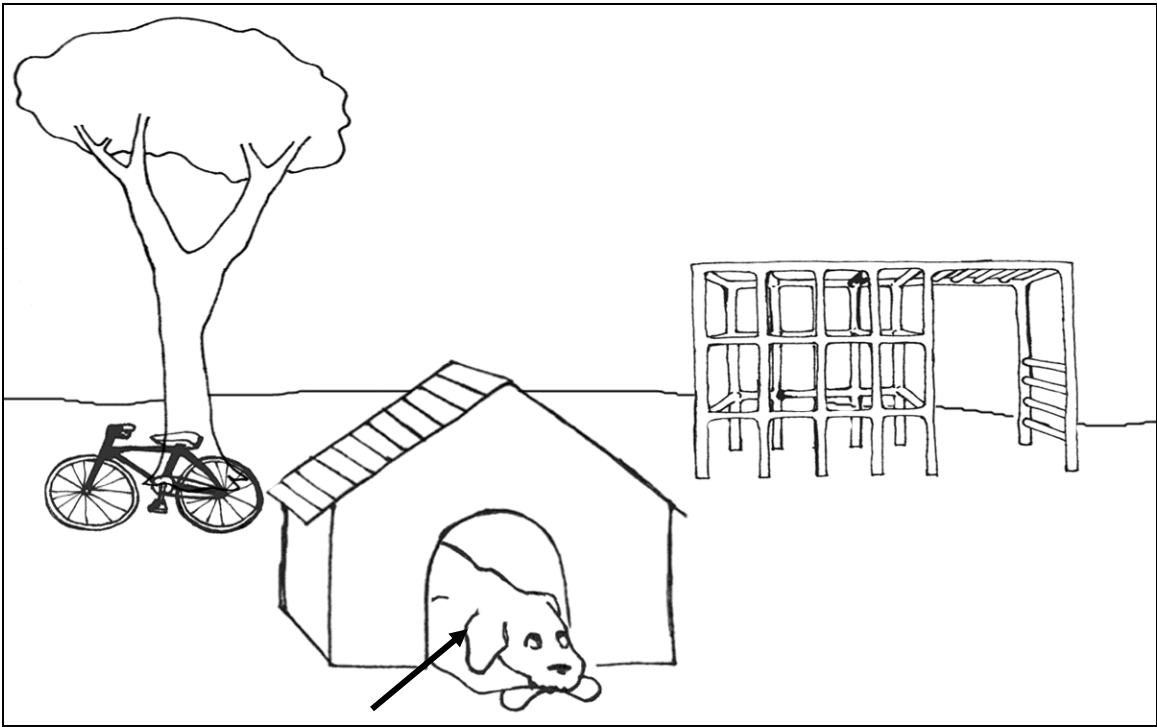

Problem 15-
1b

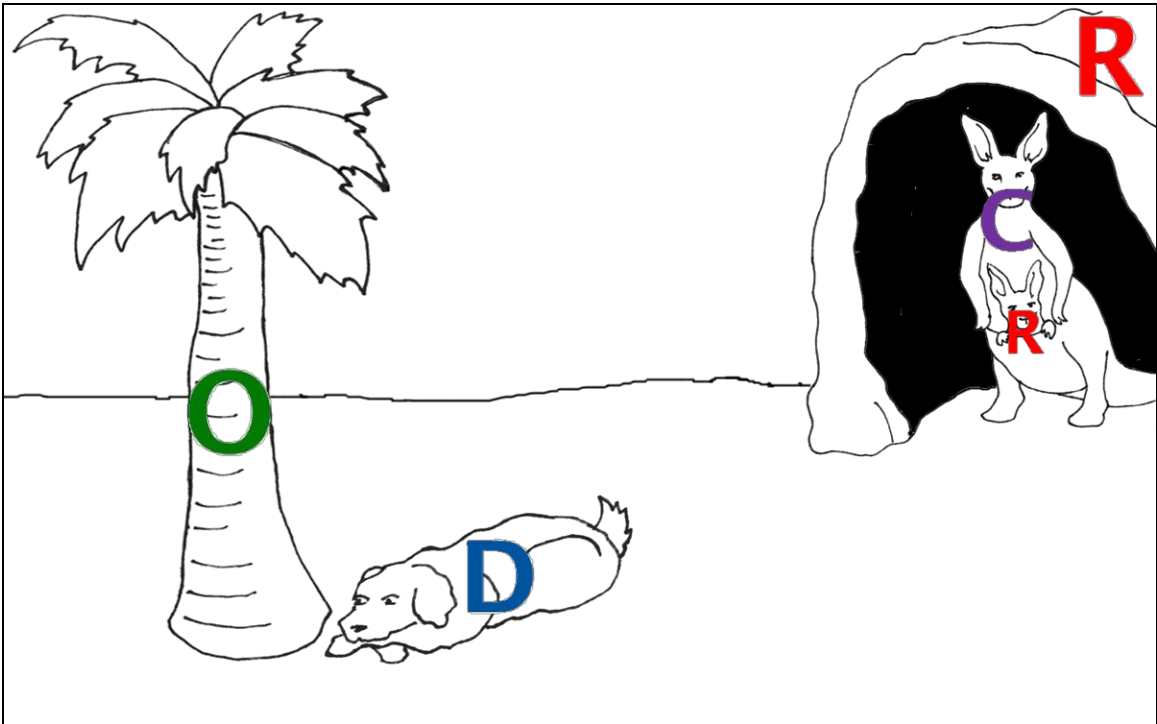
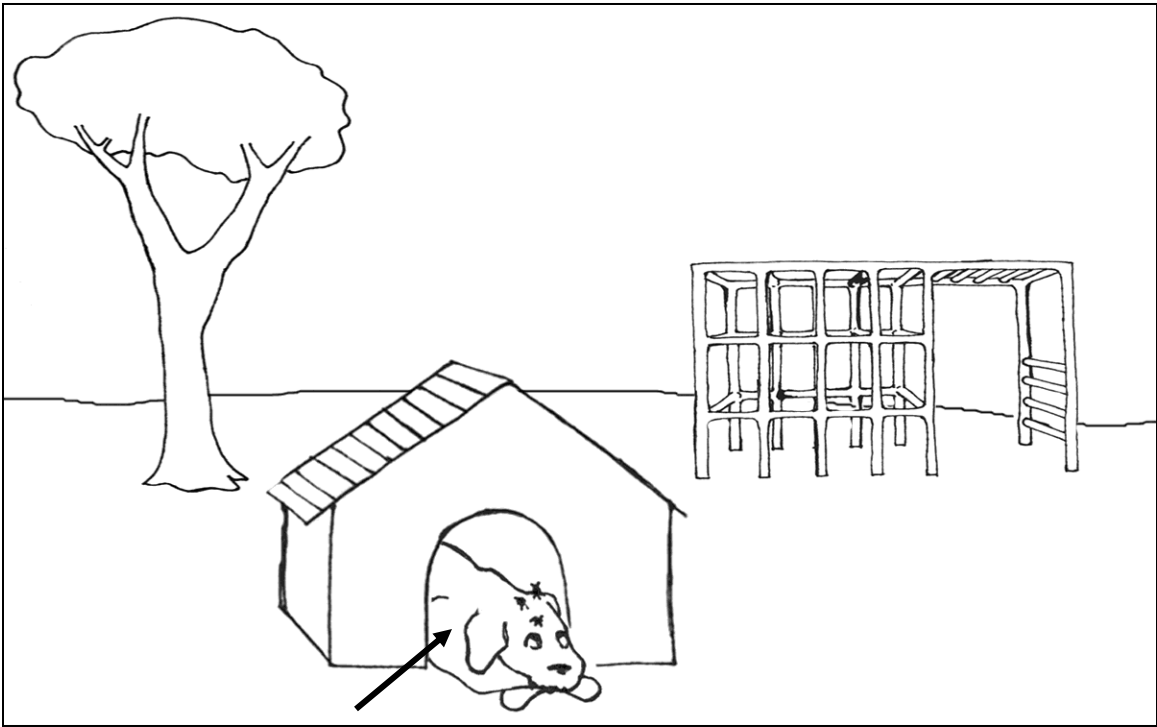

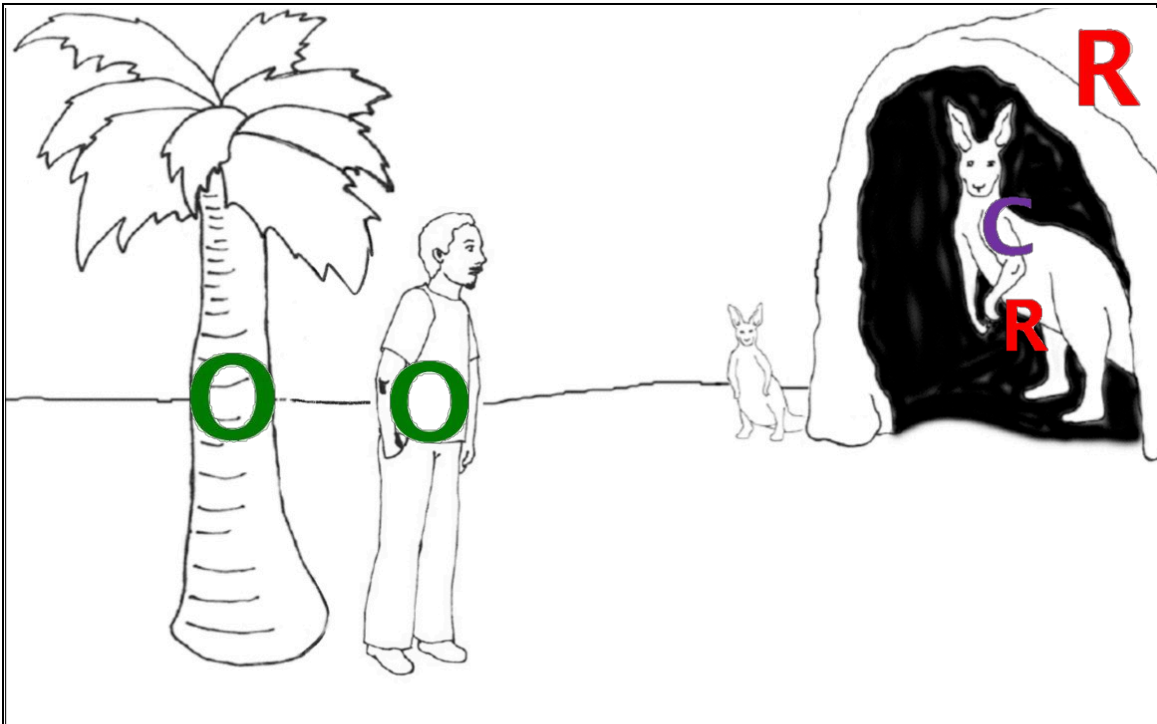
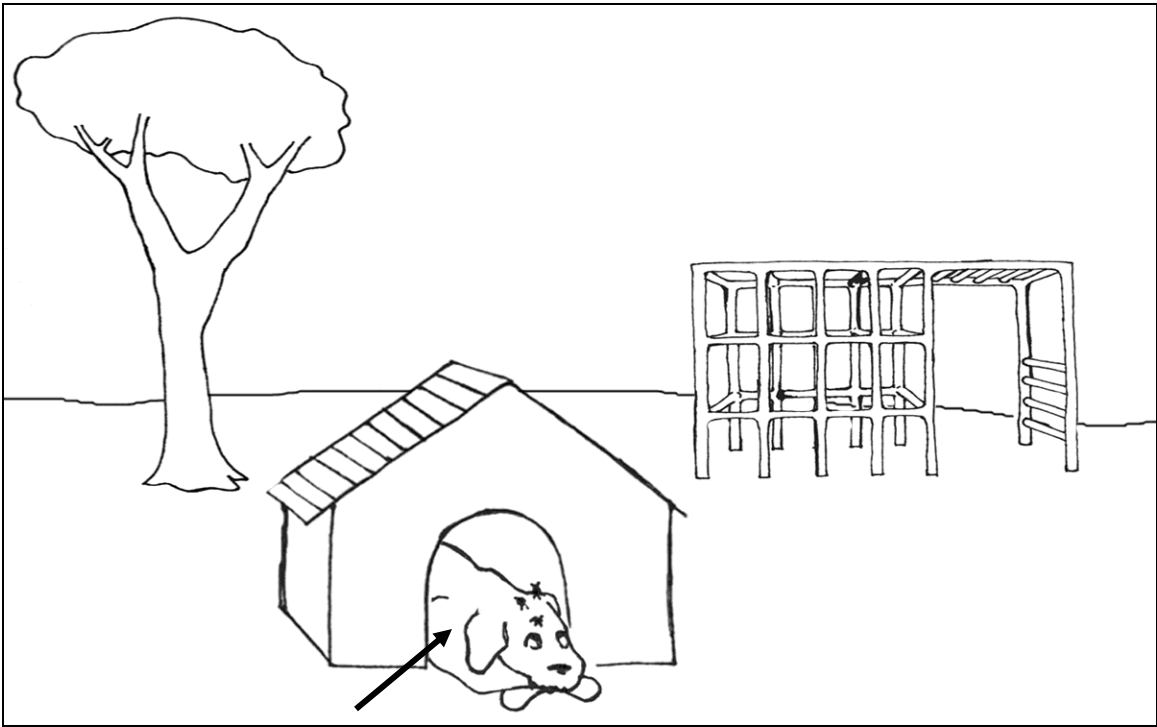

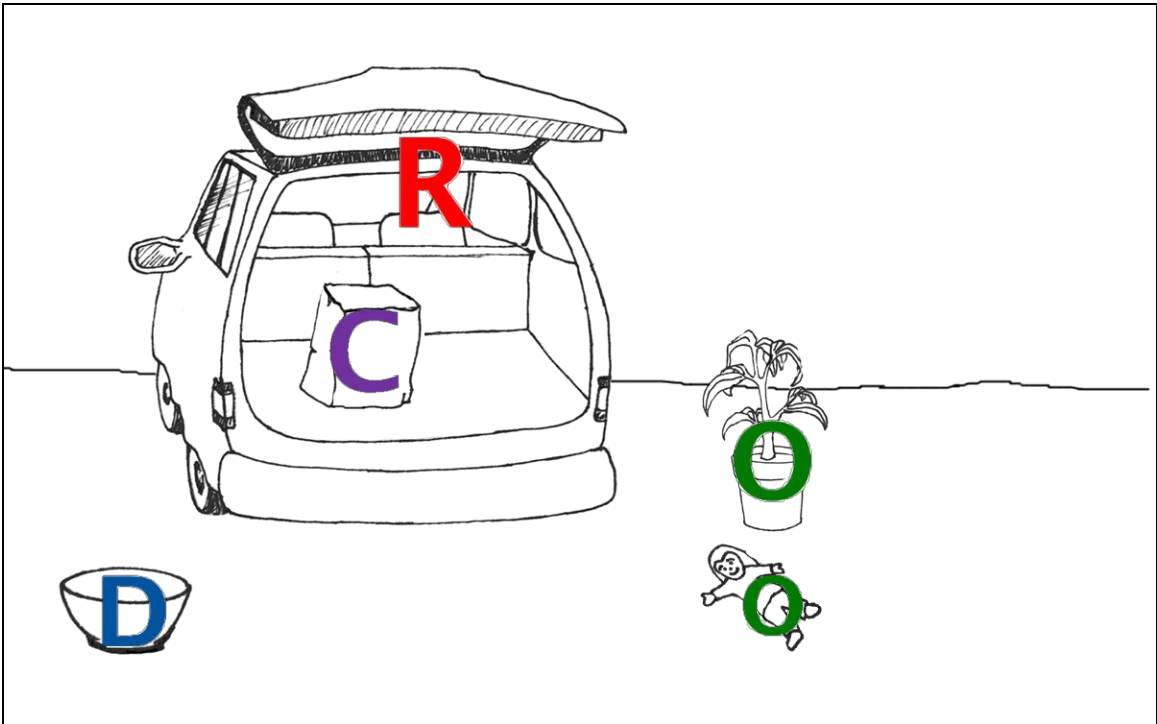
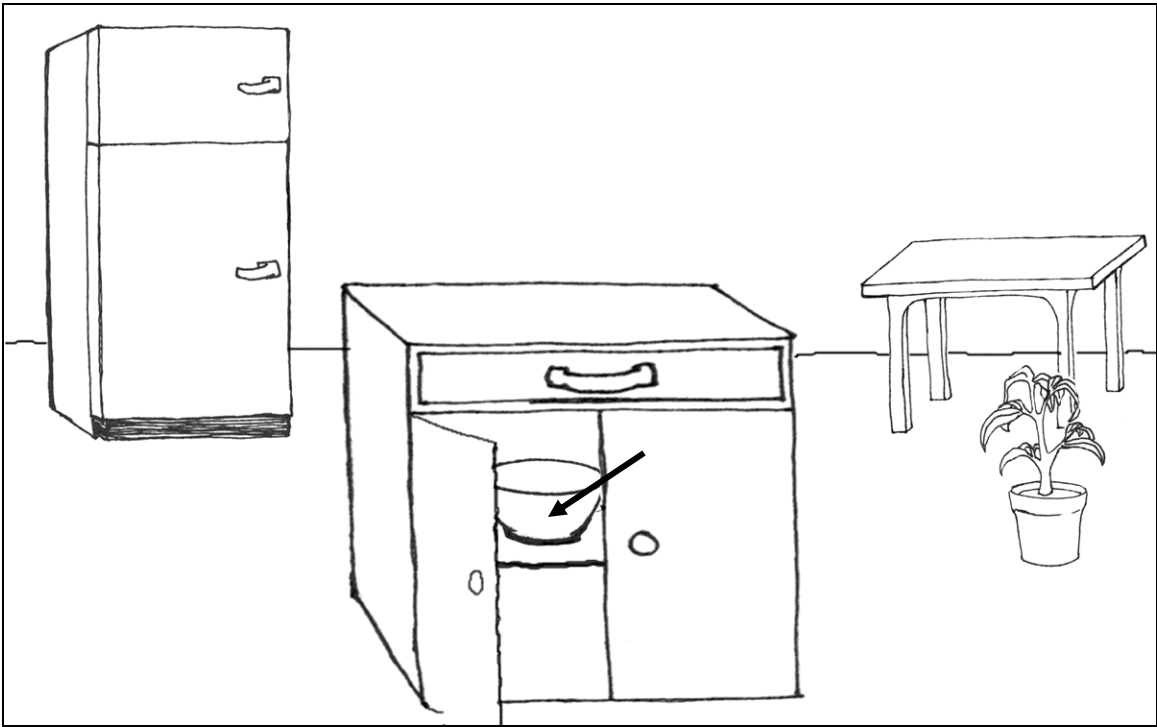

Problem 16-1a

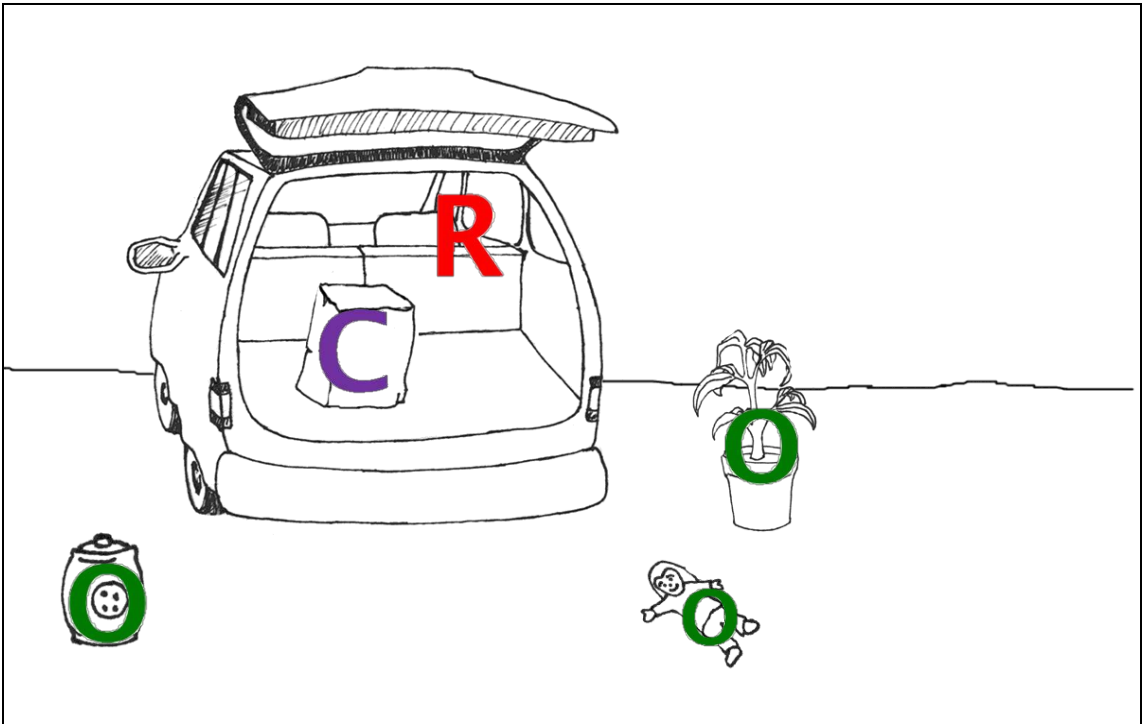
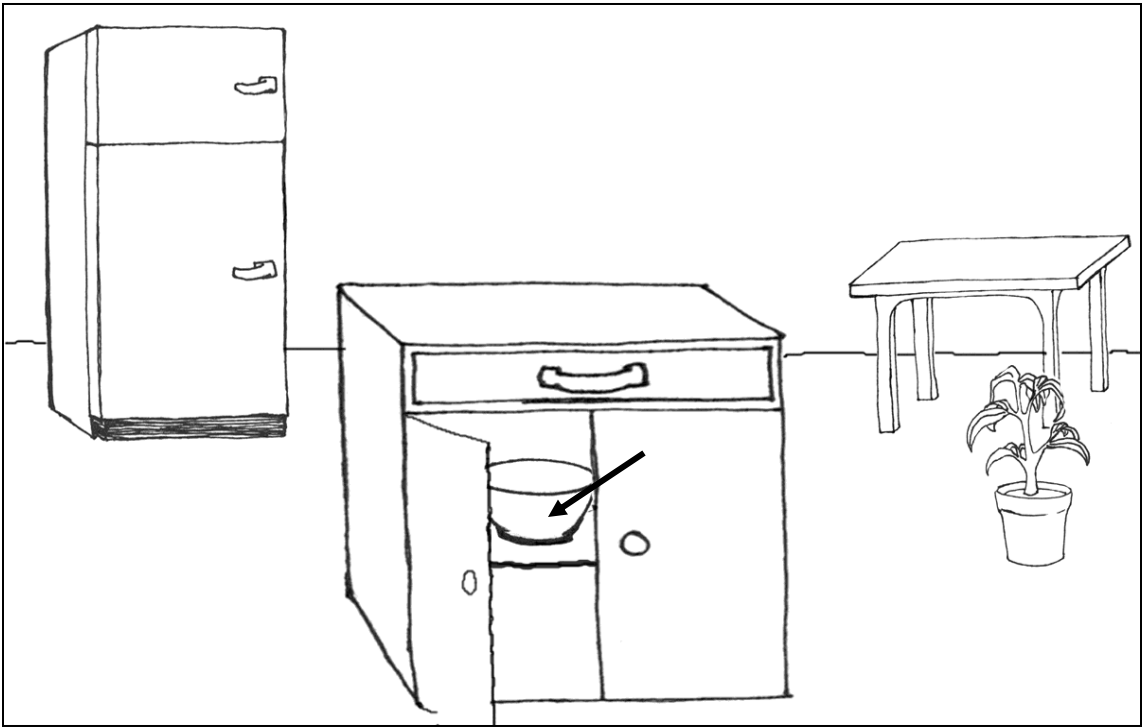

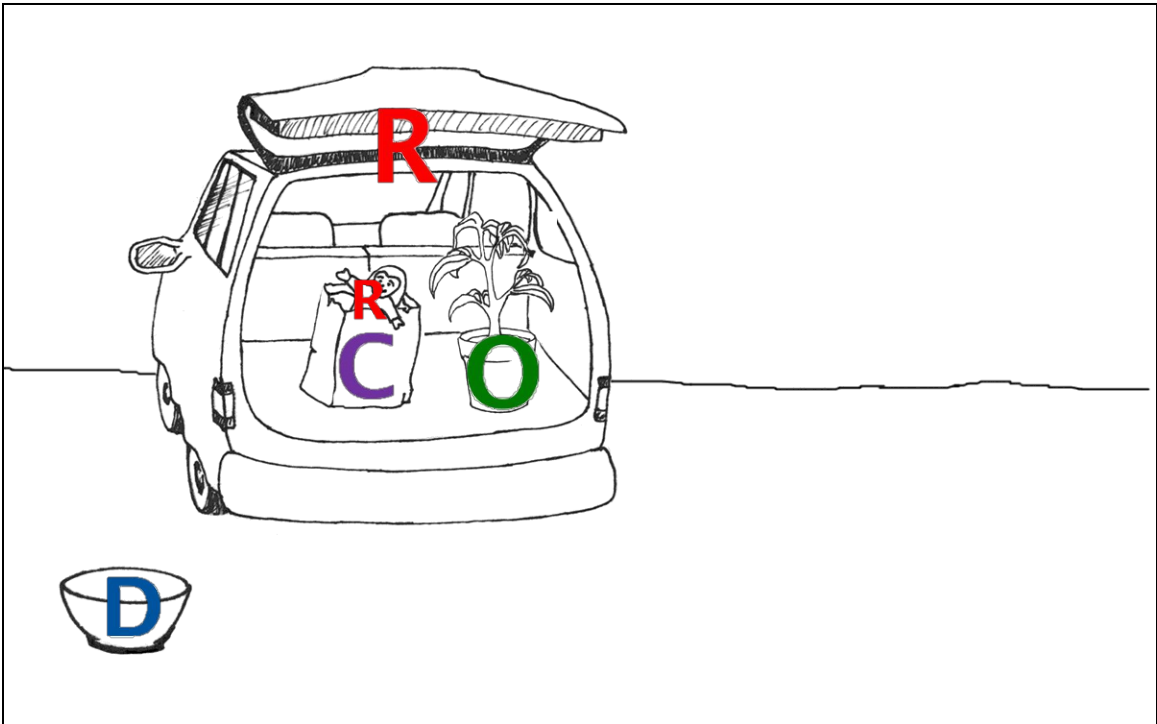
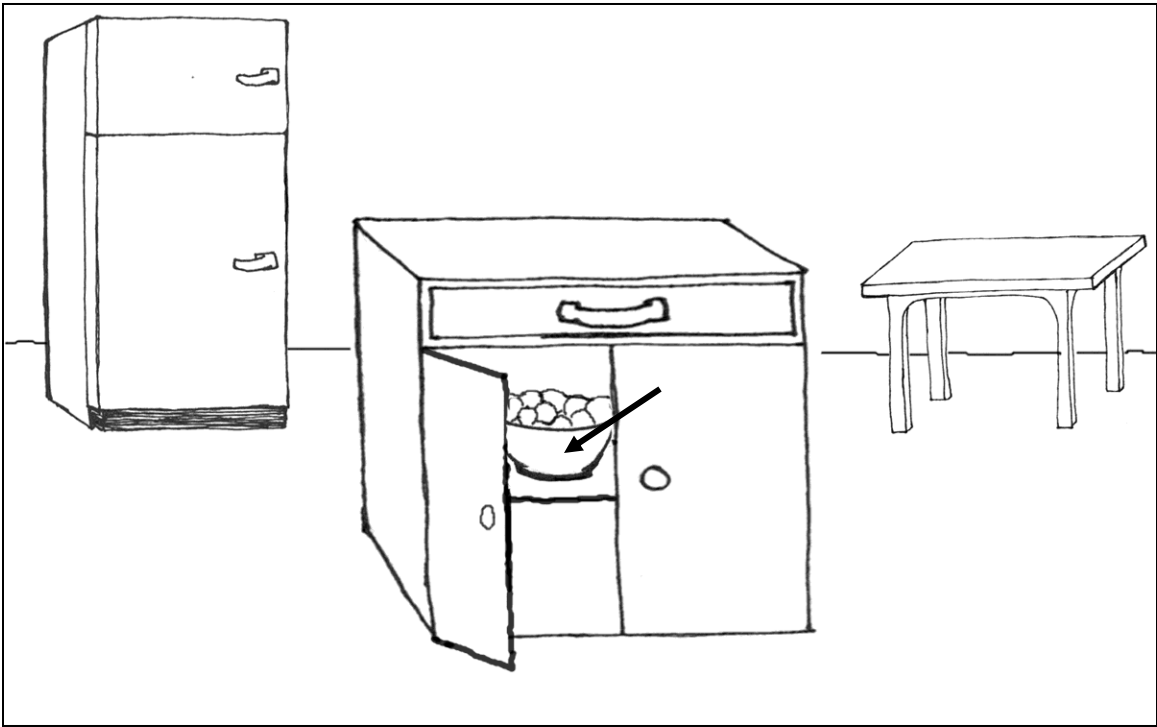

Problem 16-
2a

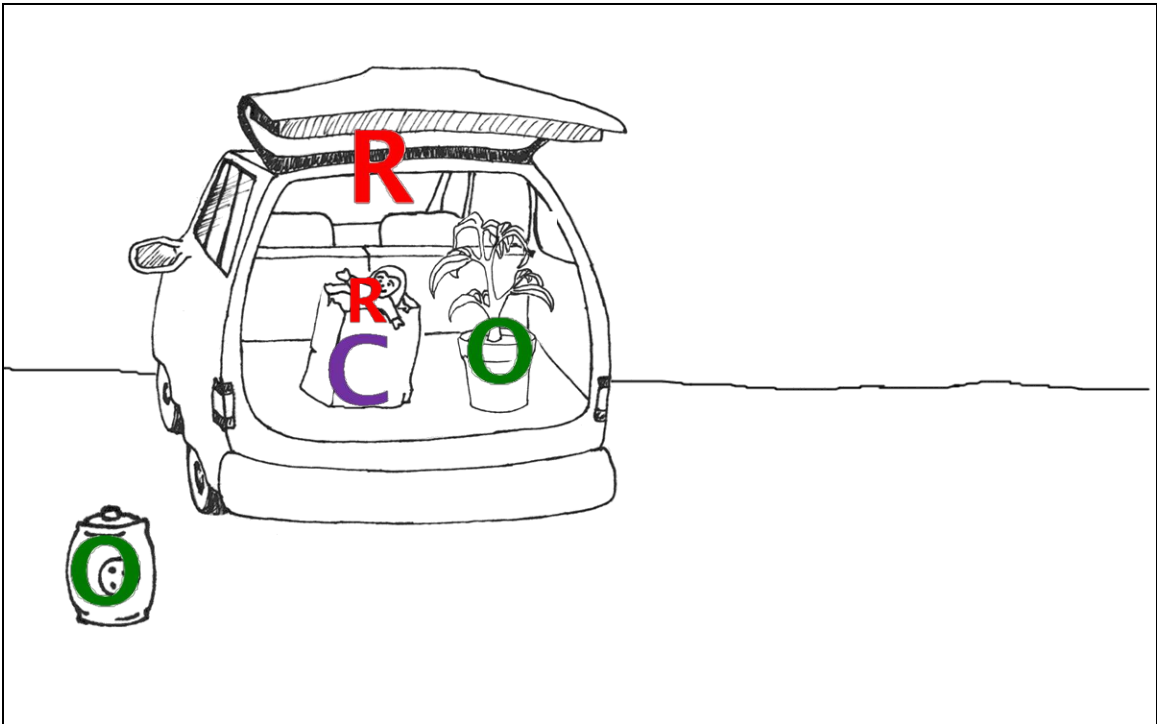
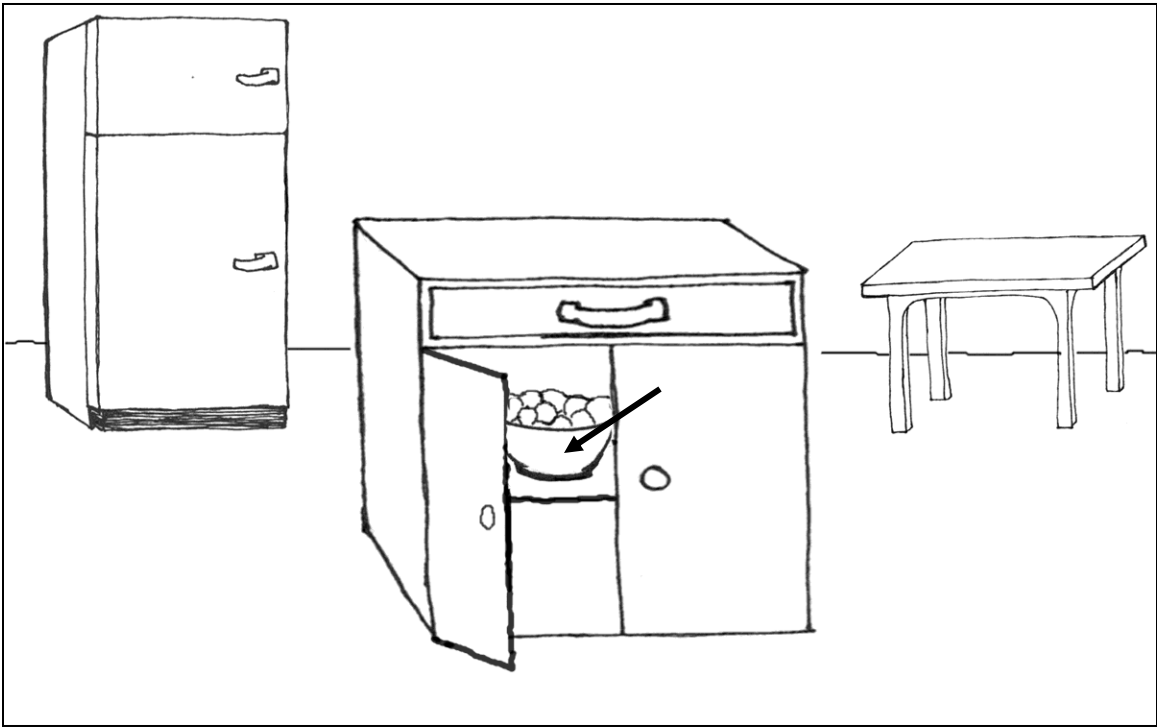

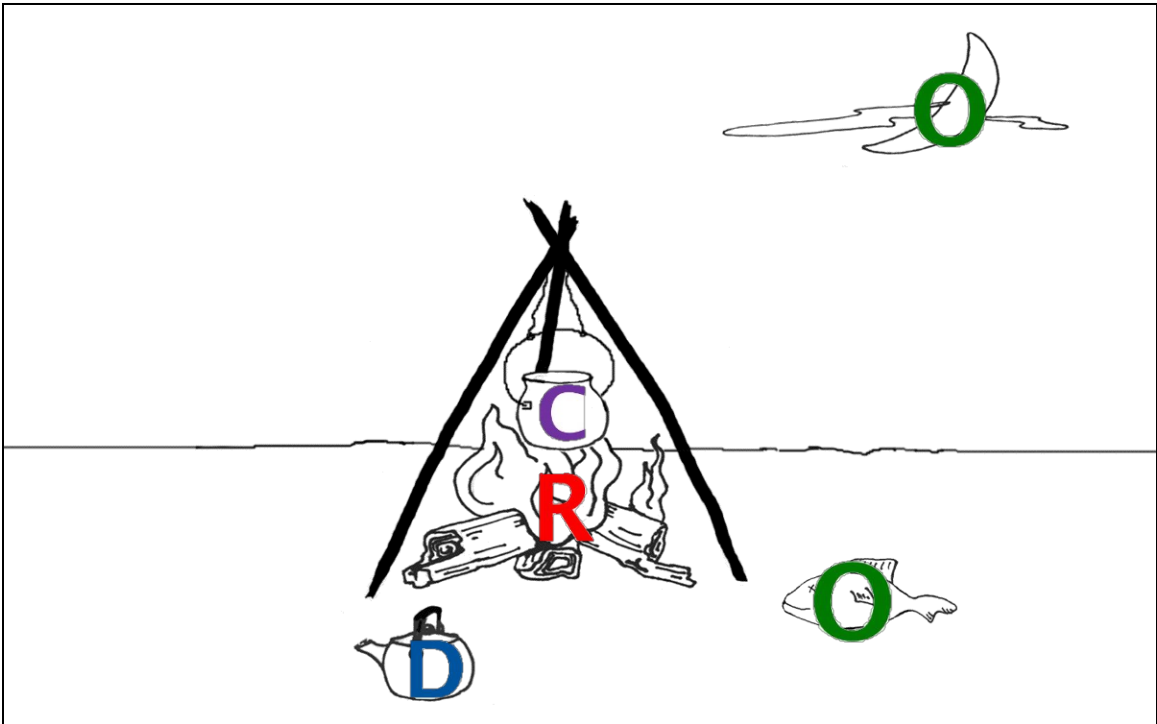
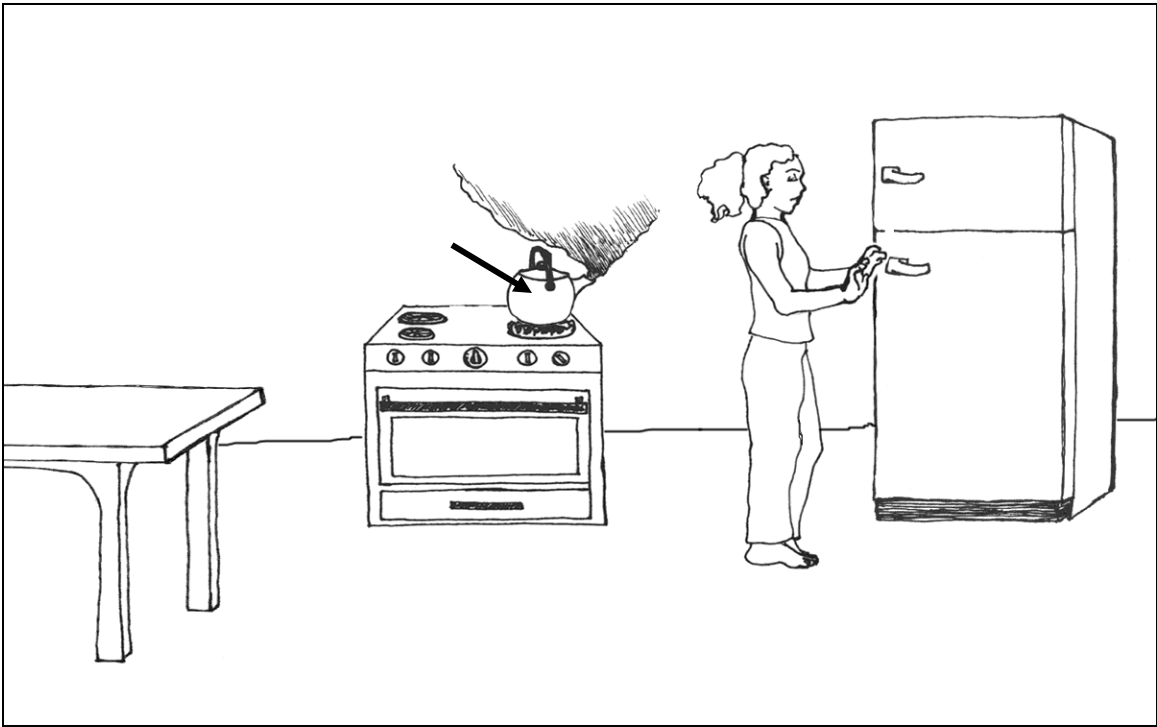

Problem 17-
1a

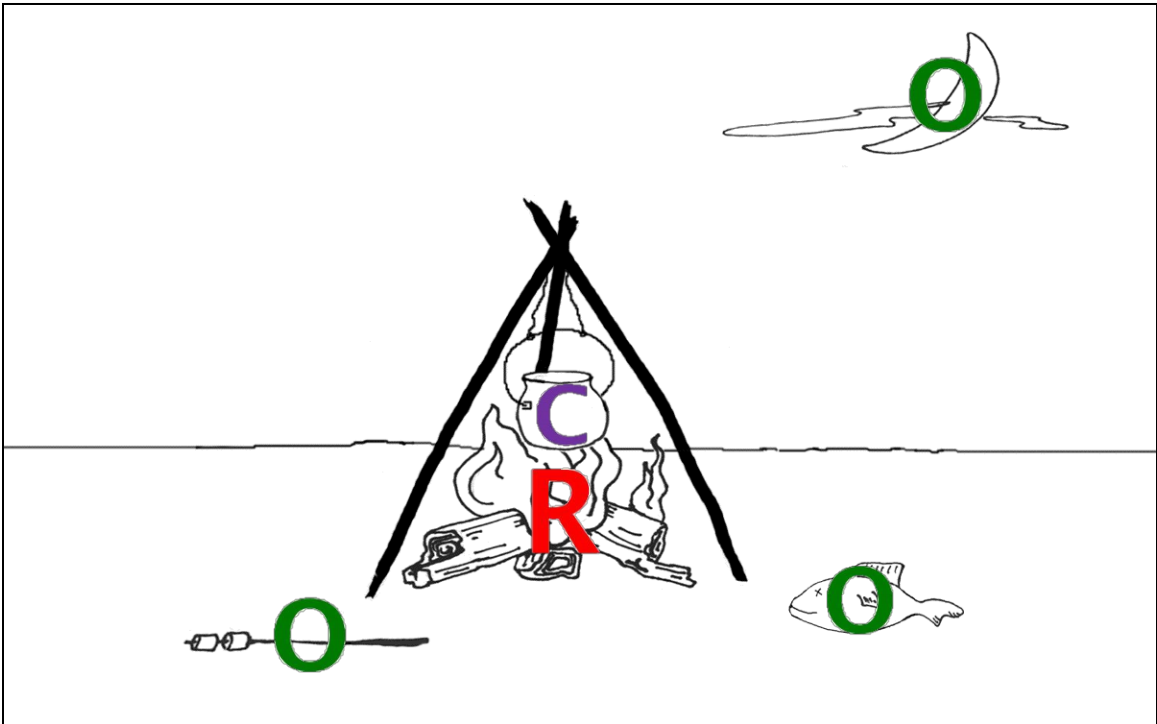
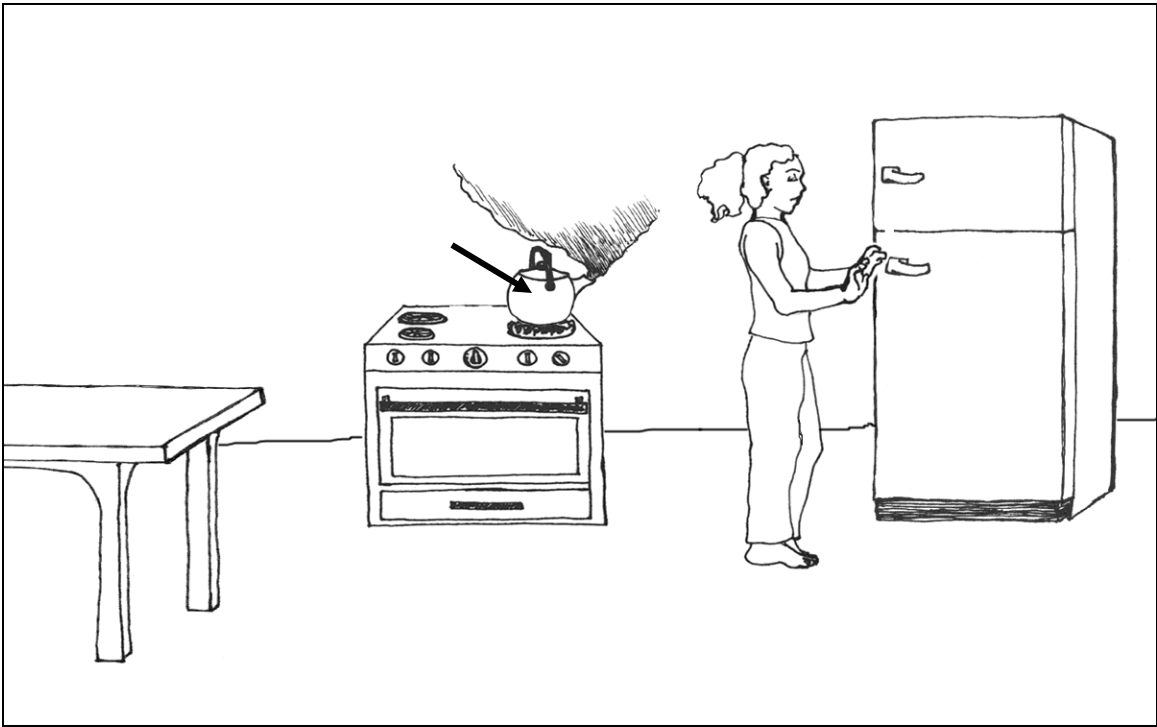

Problem 17-
1b

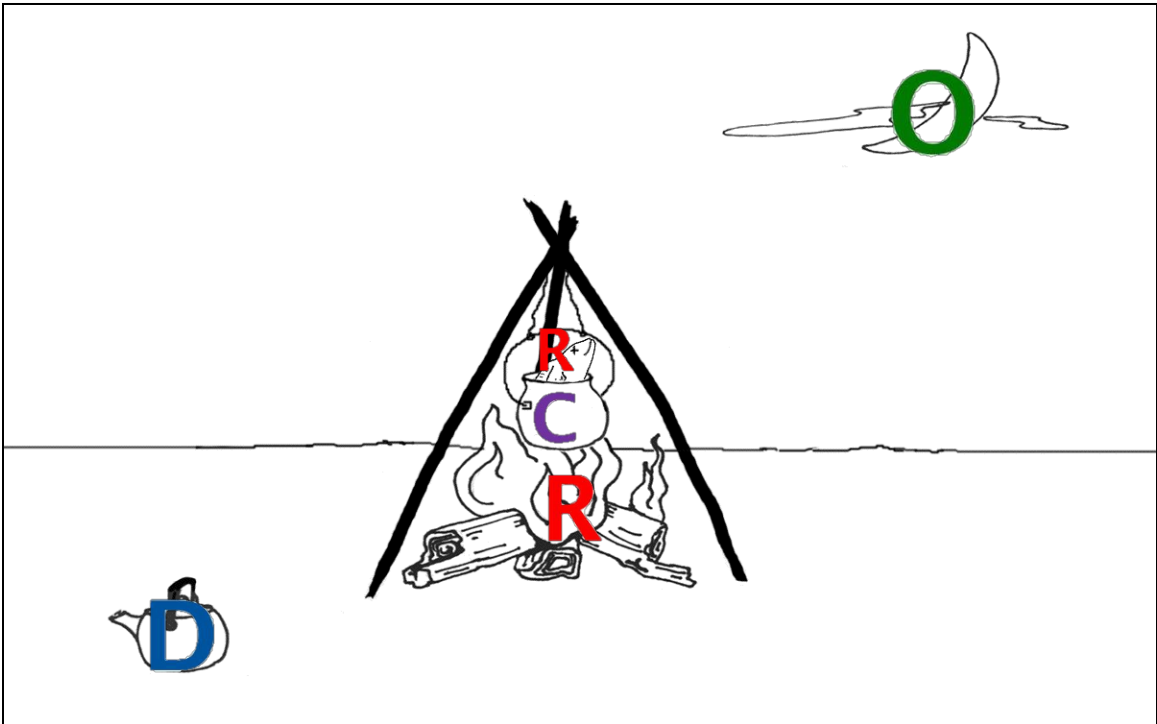
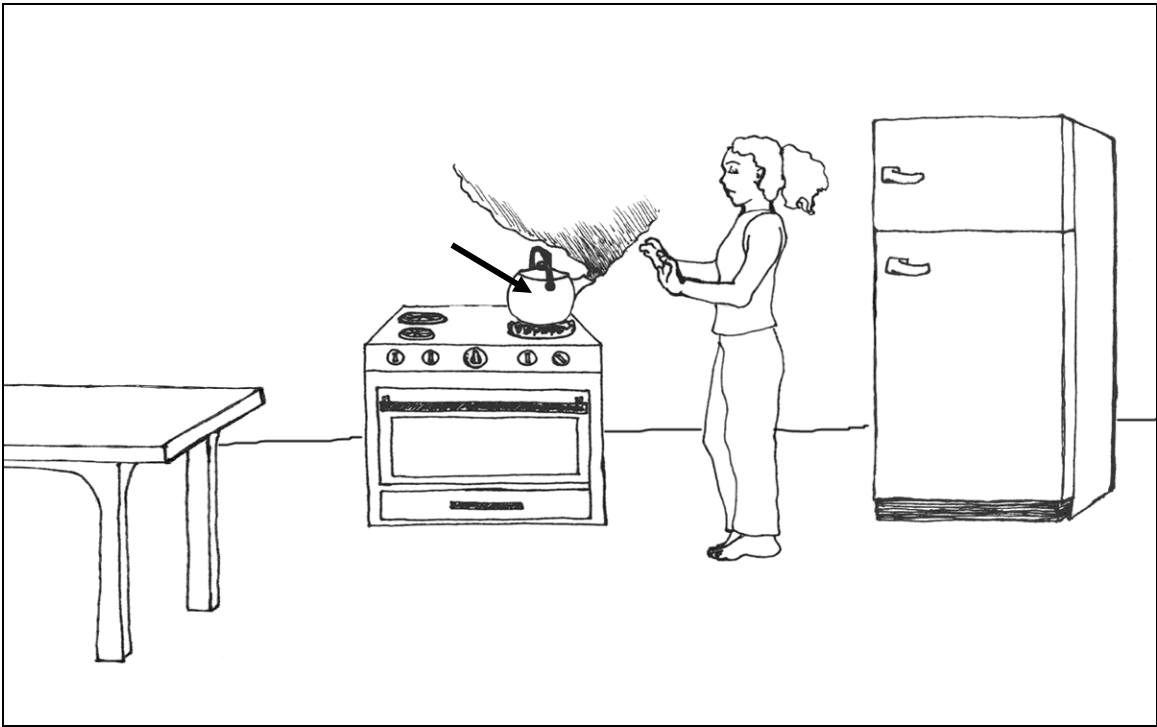

Problem 17-
2a

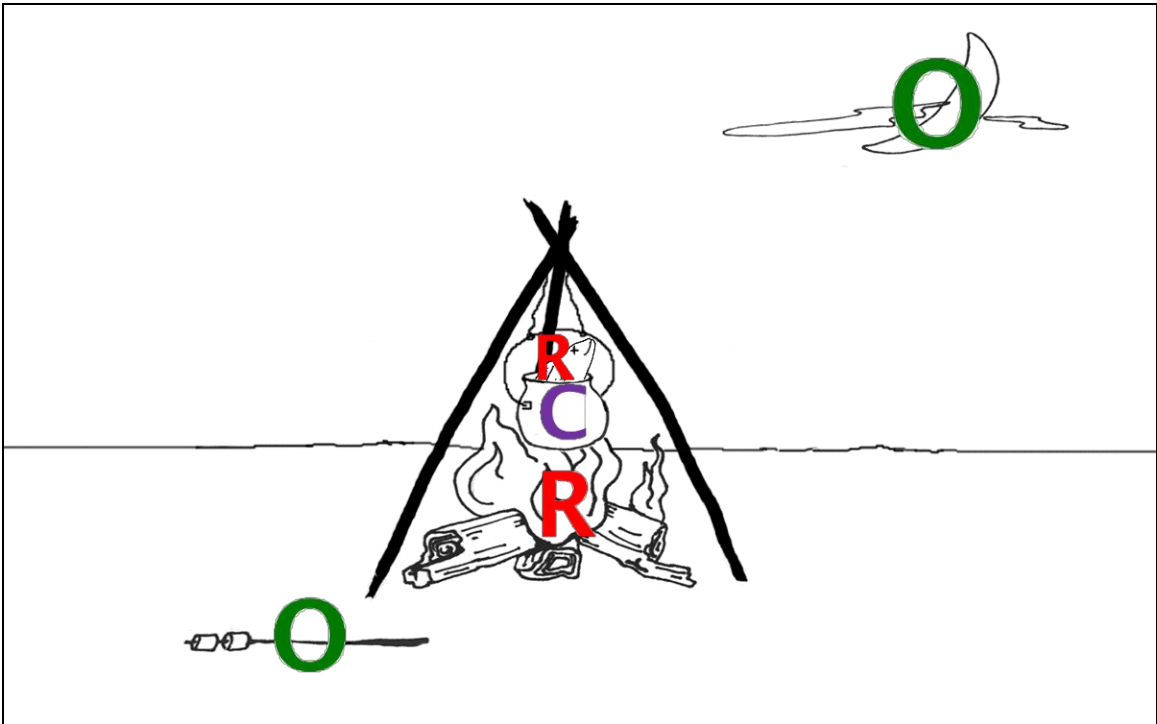
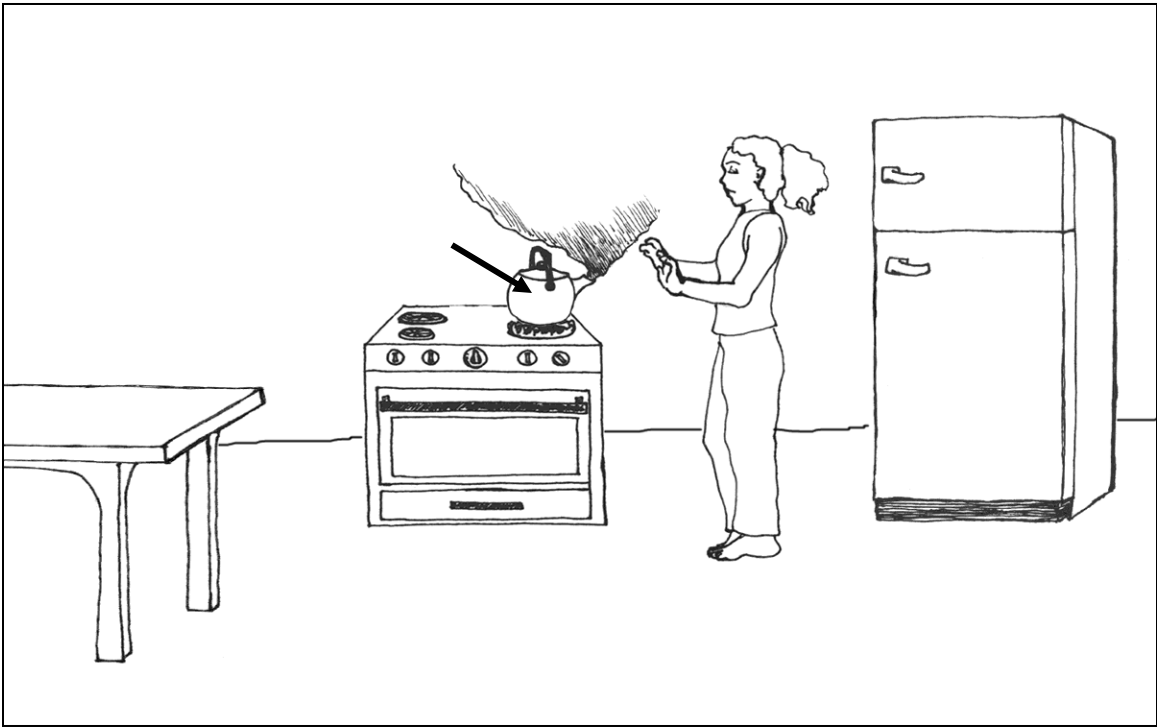

Problem 17-
2b

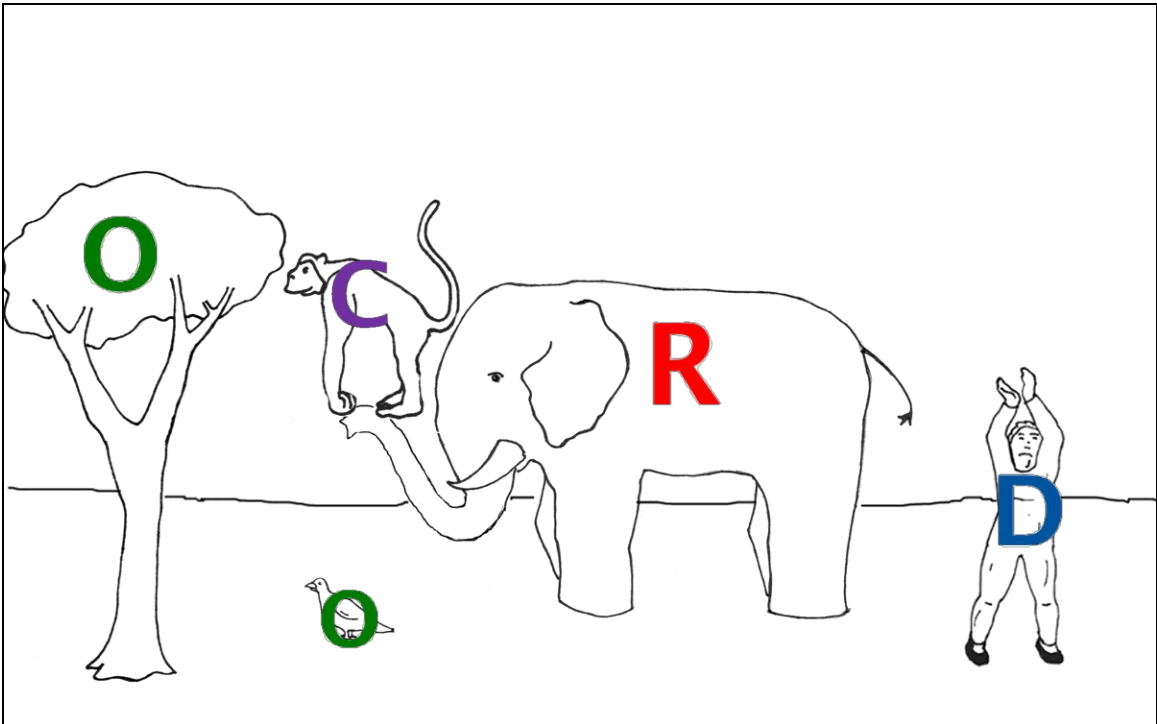
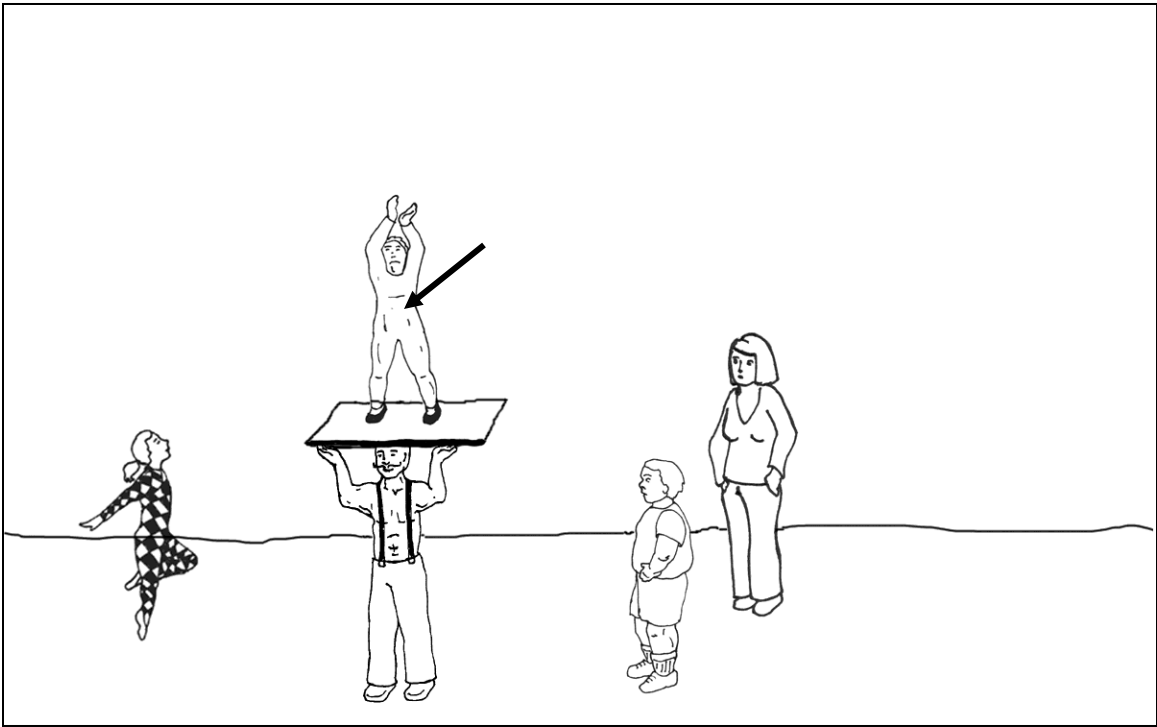

Problem 18-
1a

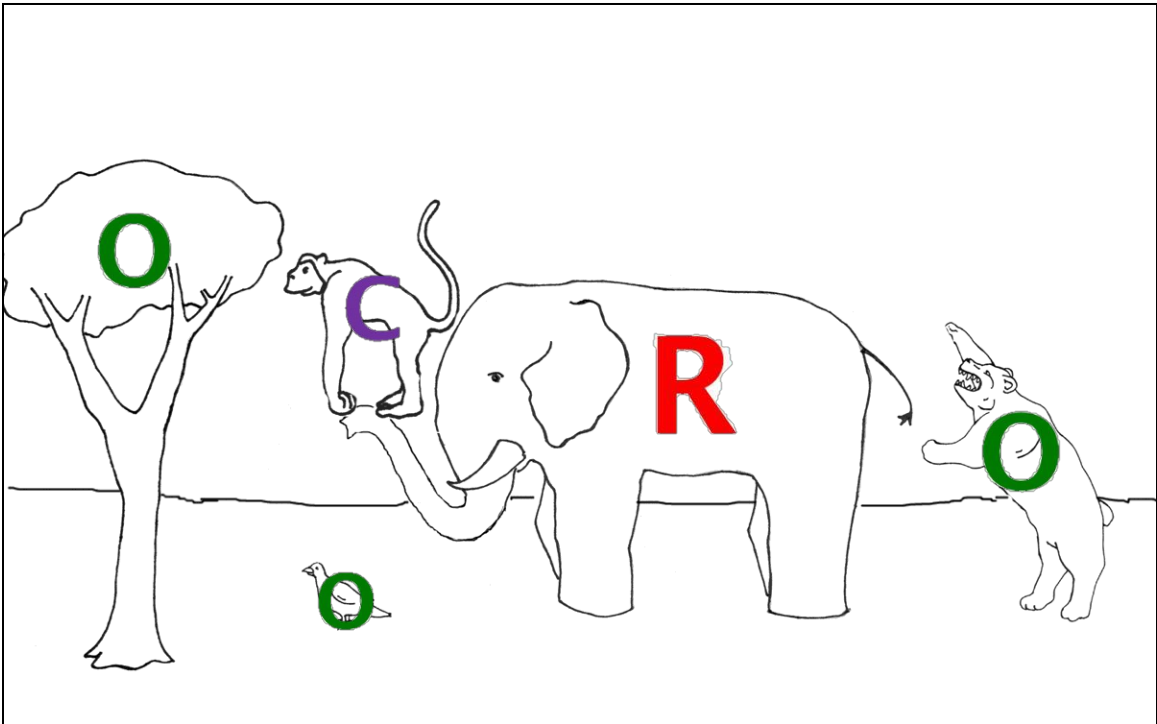
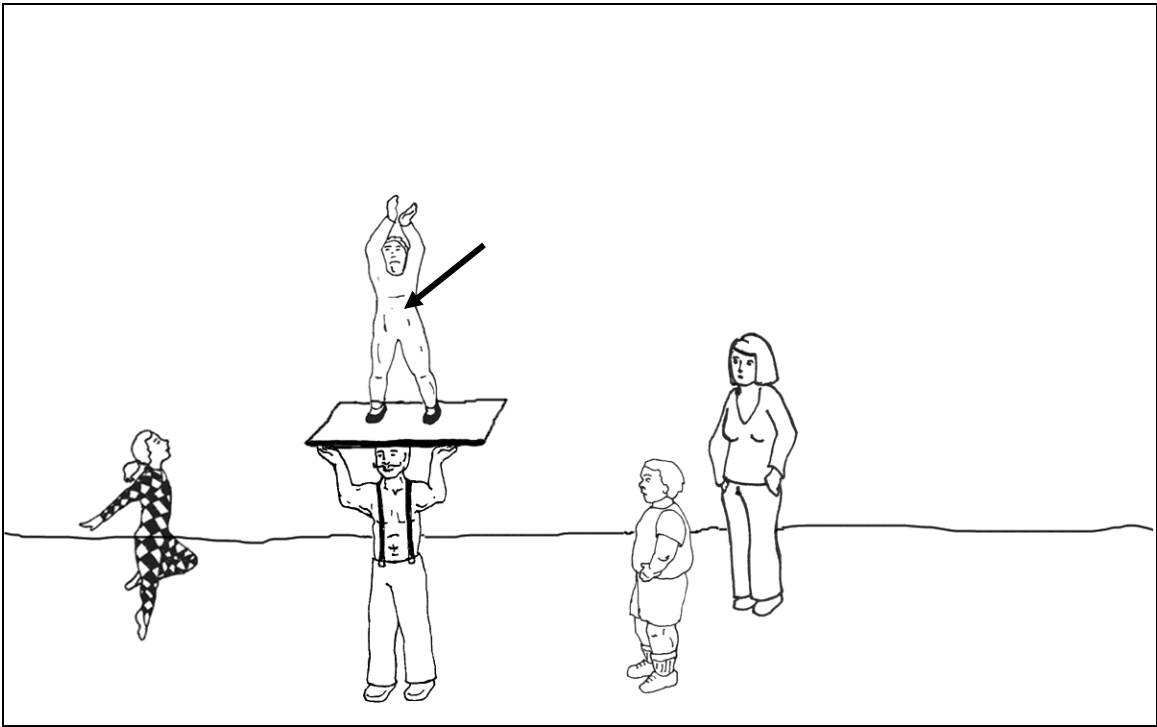

Problem 18-
1b

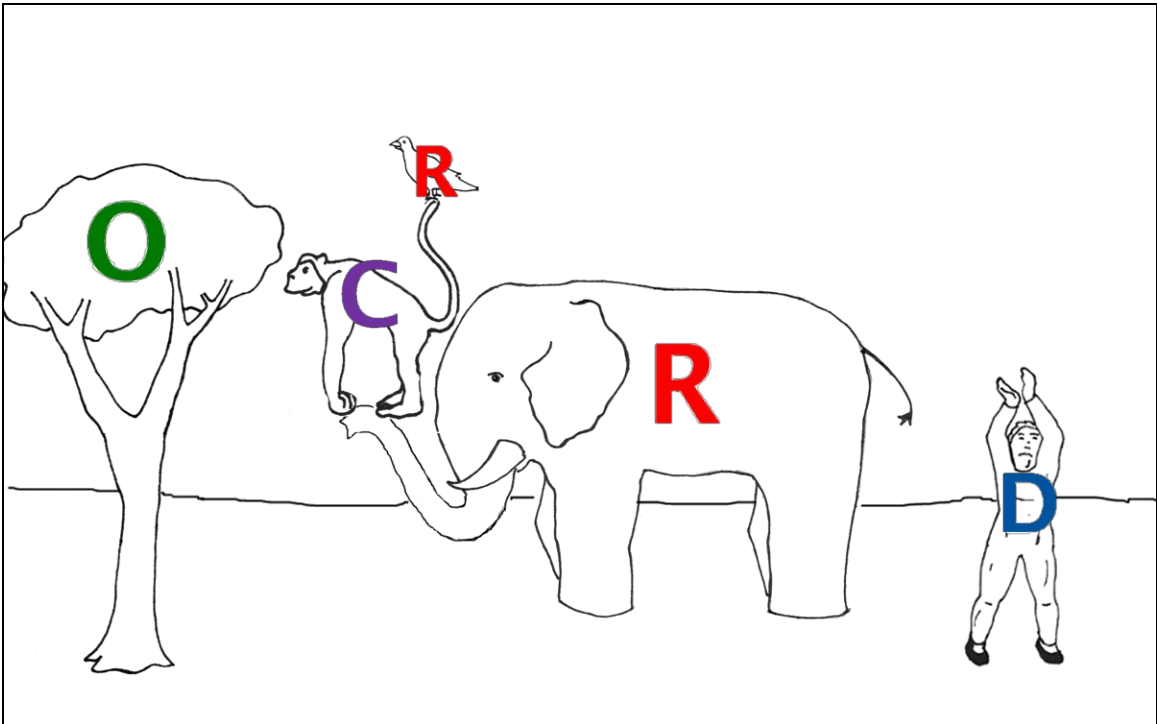
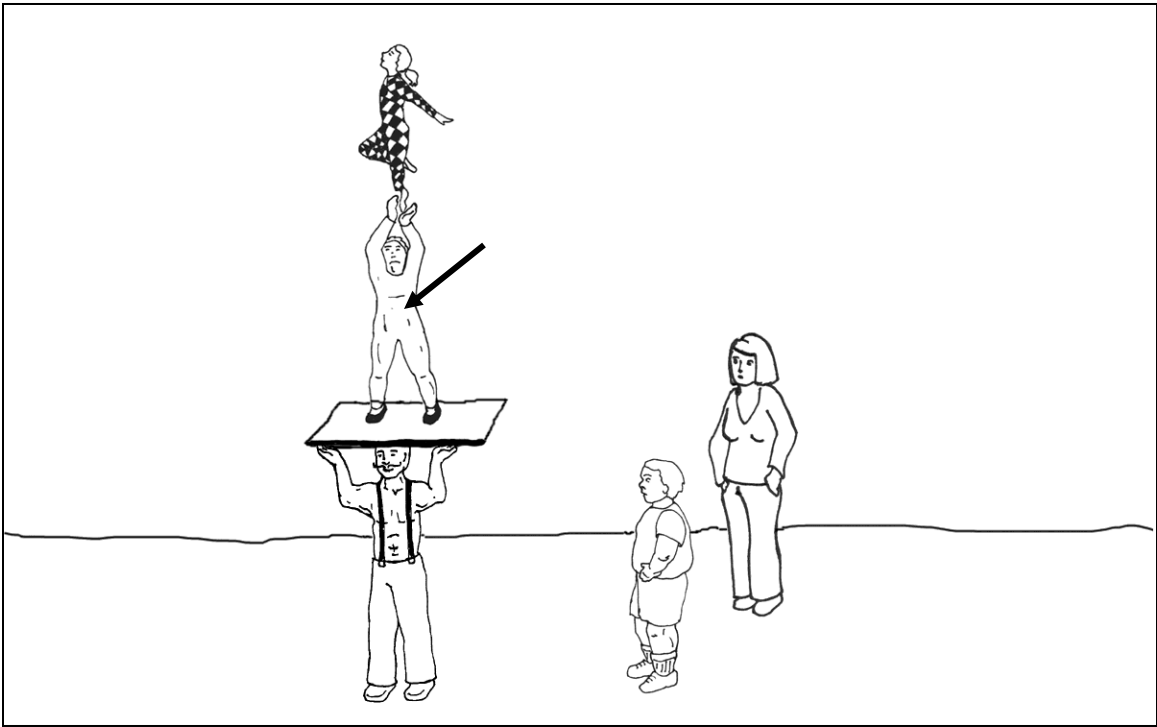

Problem 18-
2a

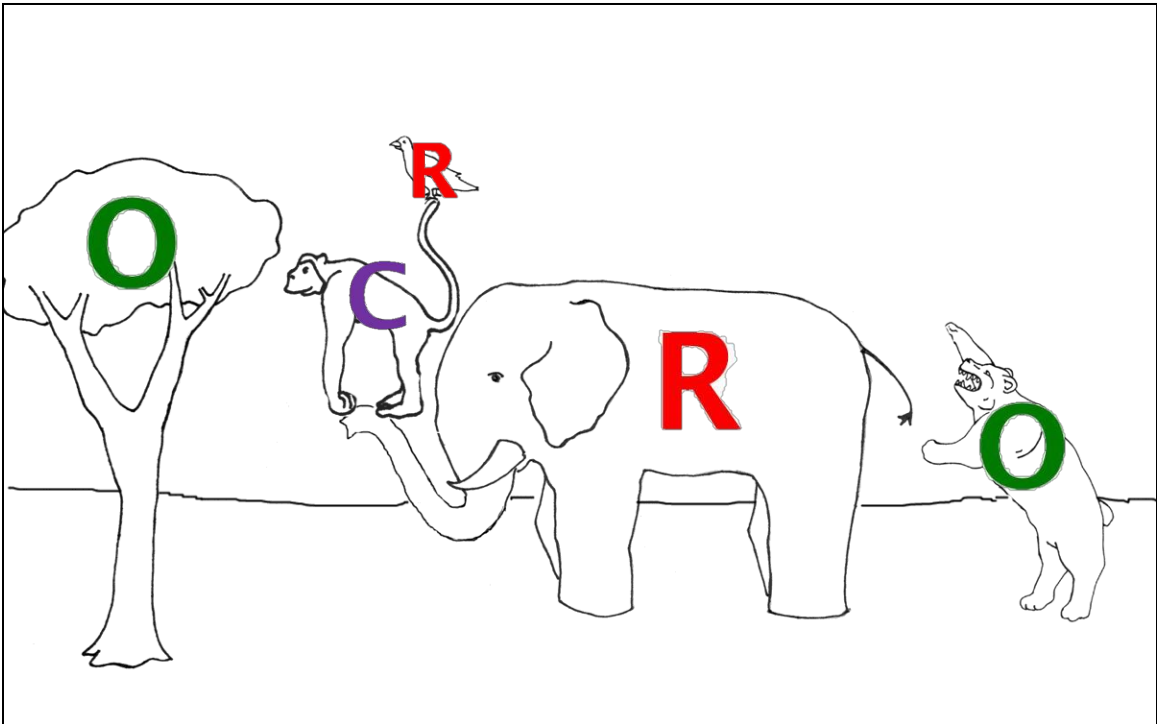
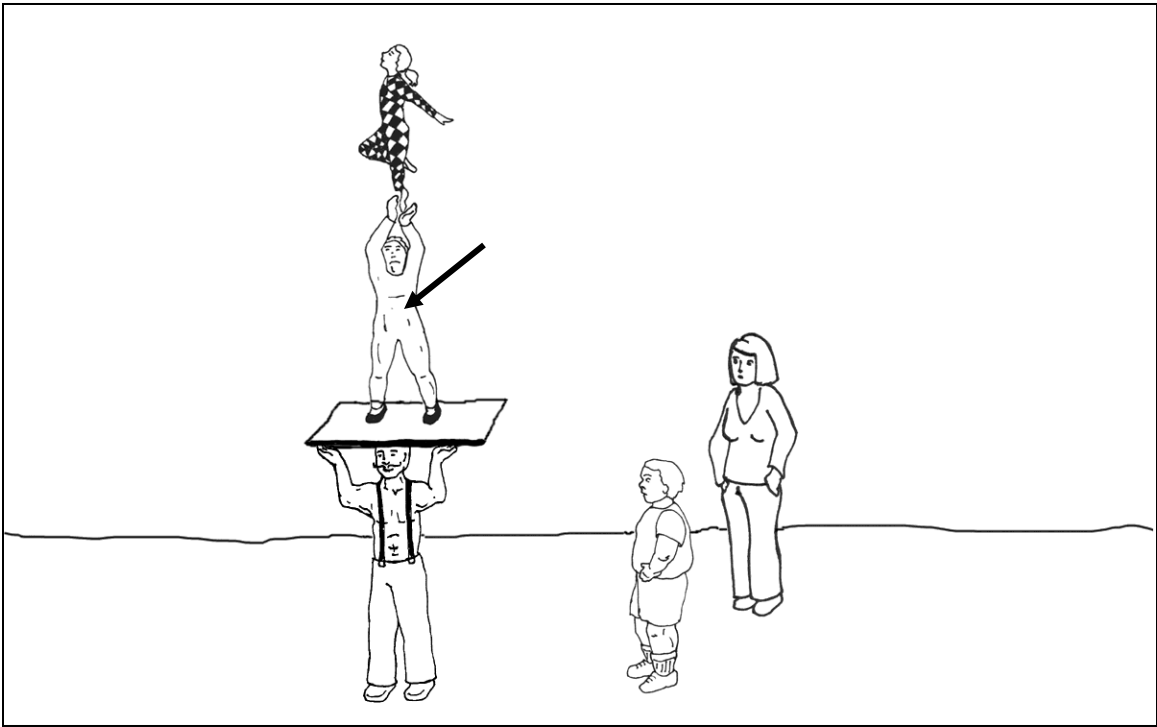

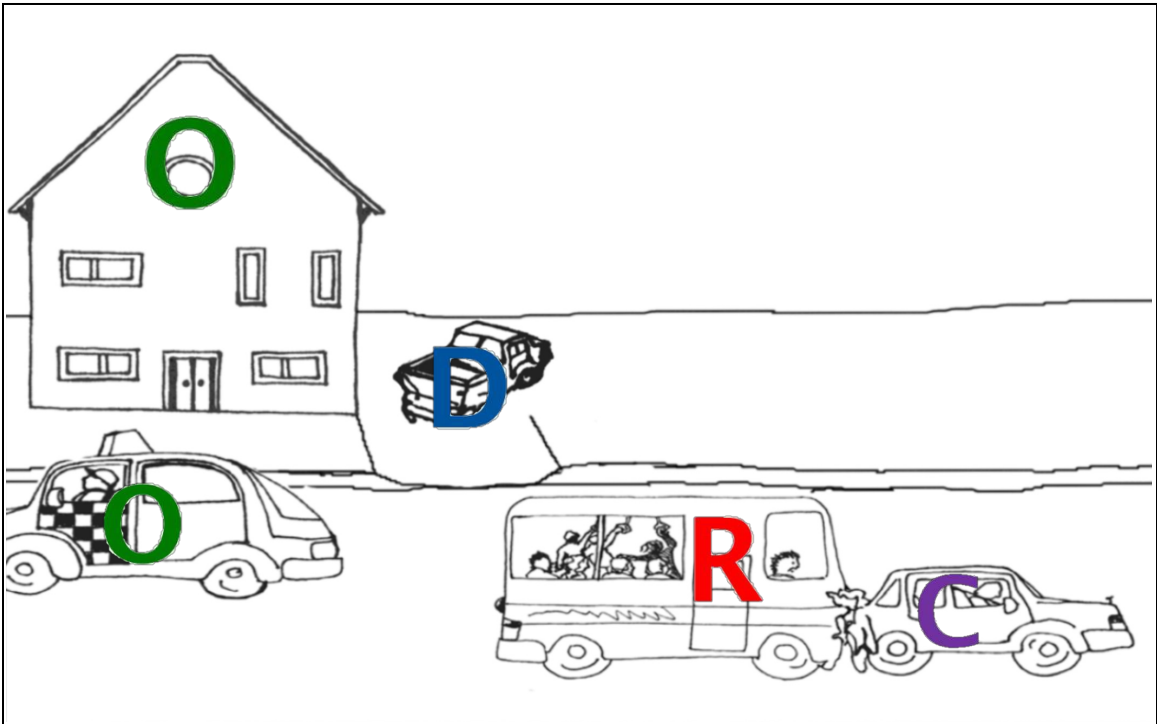
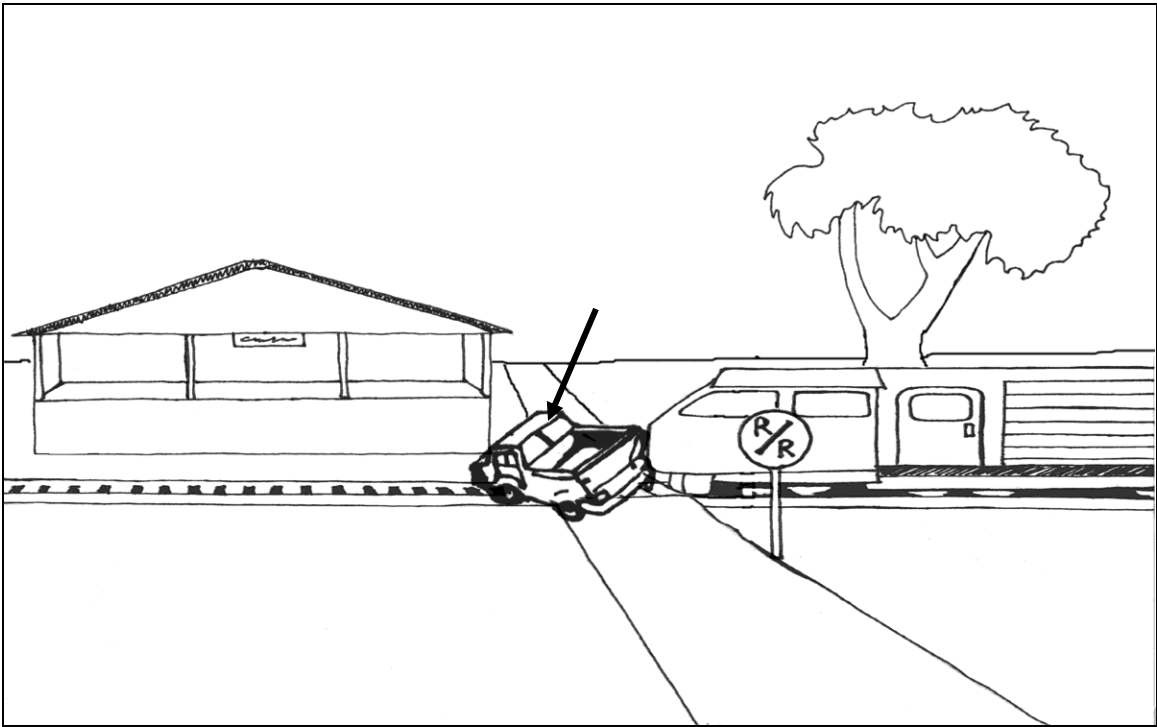

Problem 19-
1a

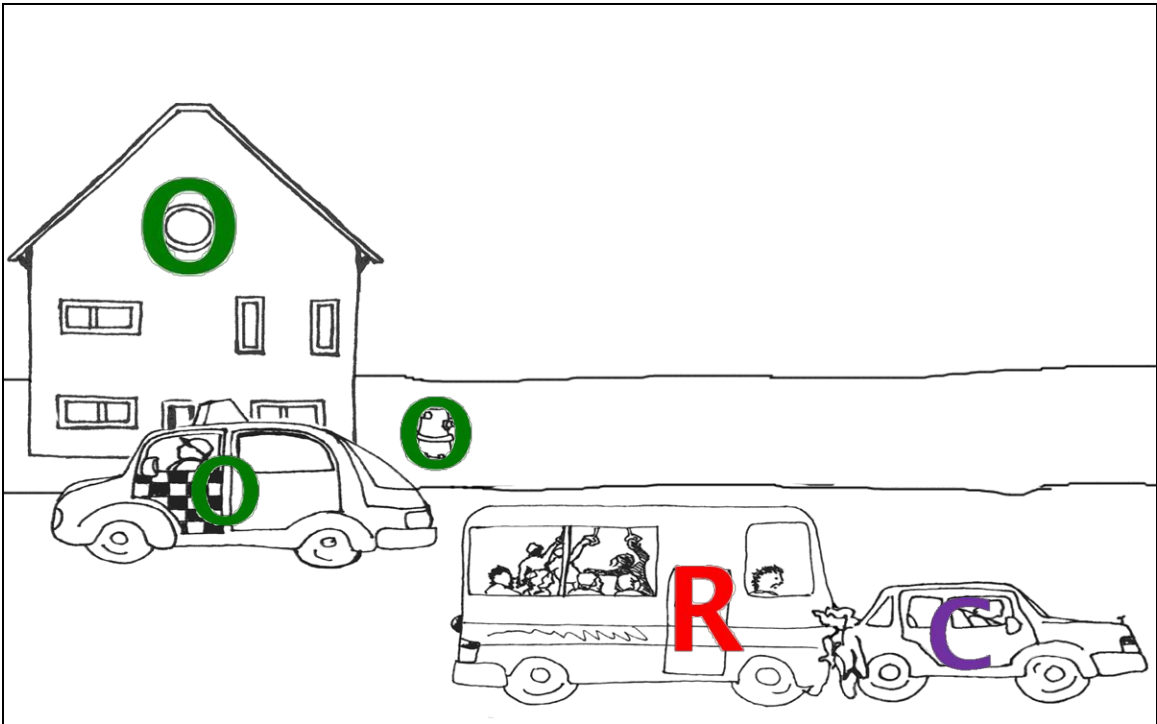
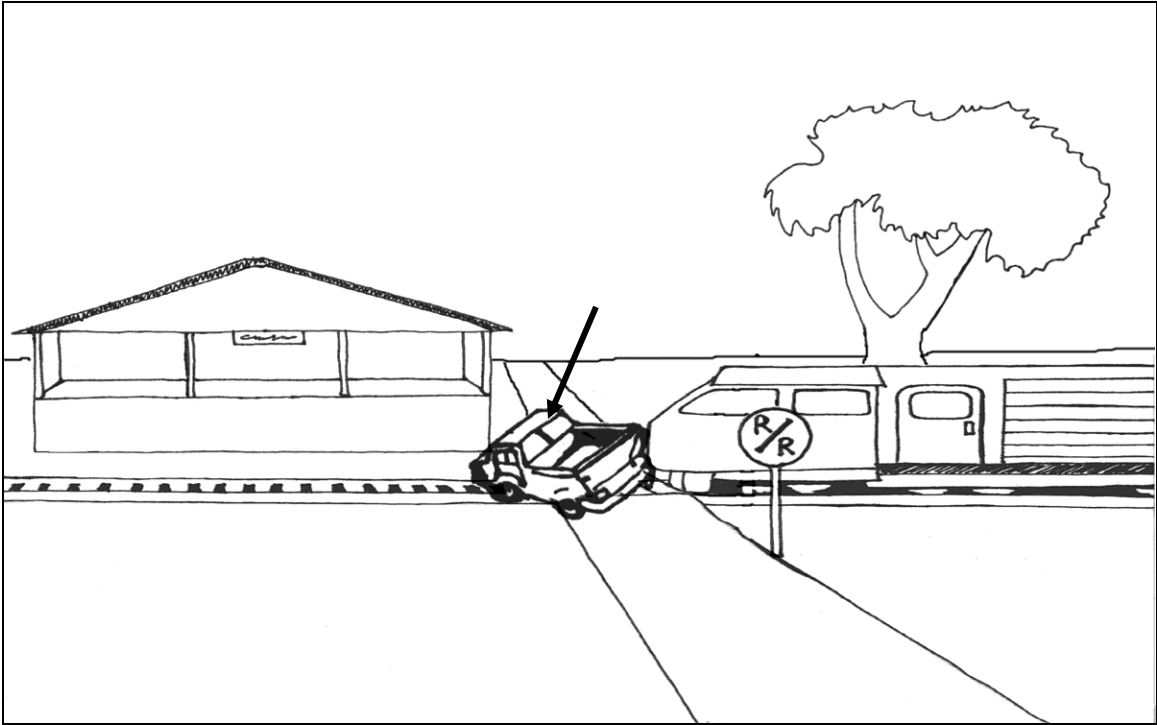

Problem 19-
1b

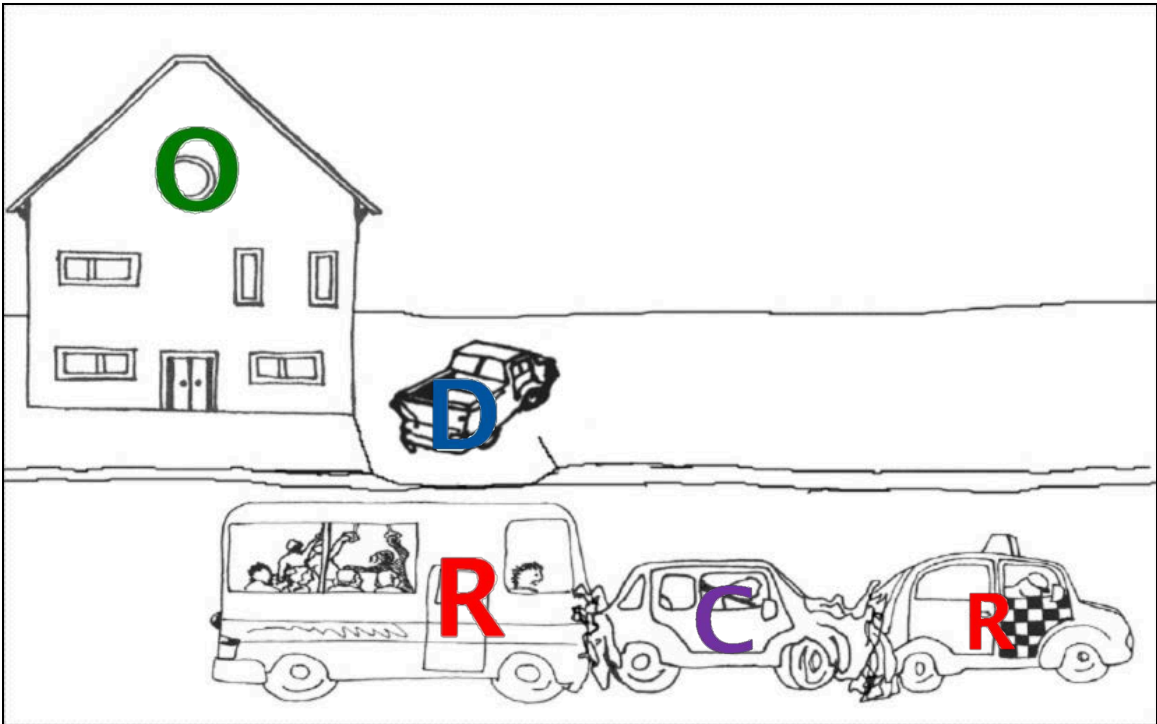
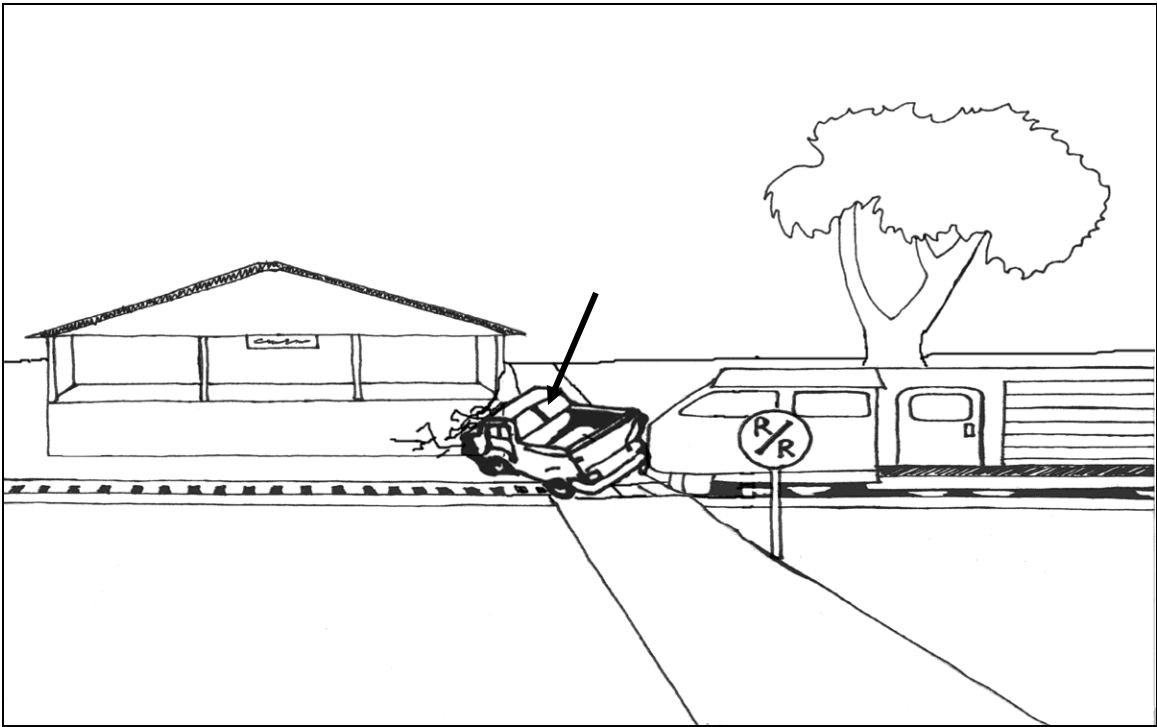

Problem 19-
2a

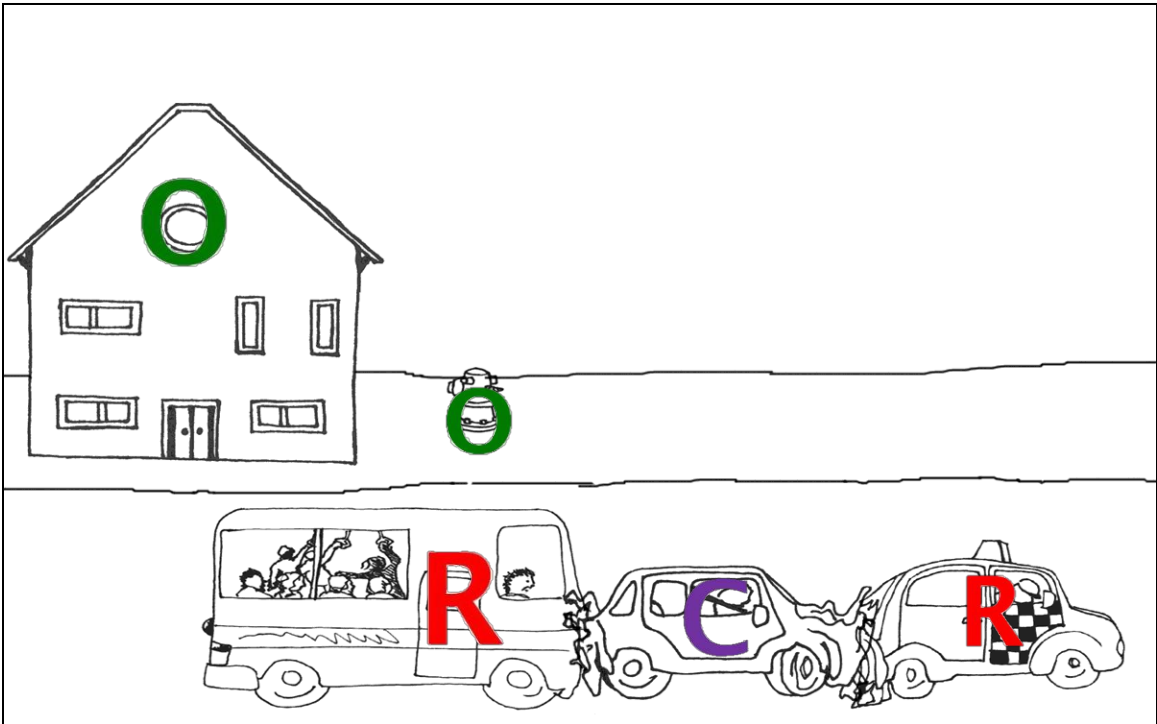
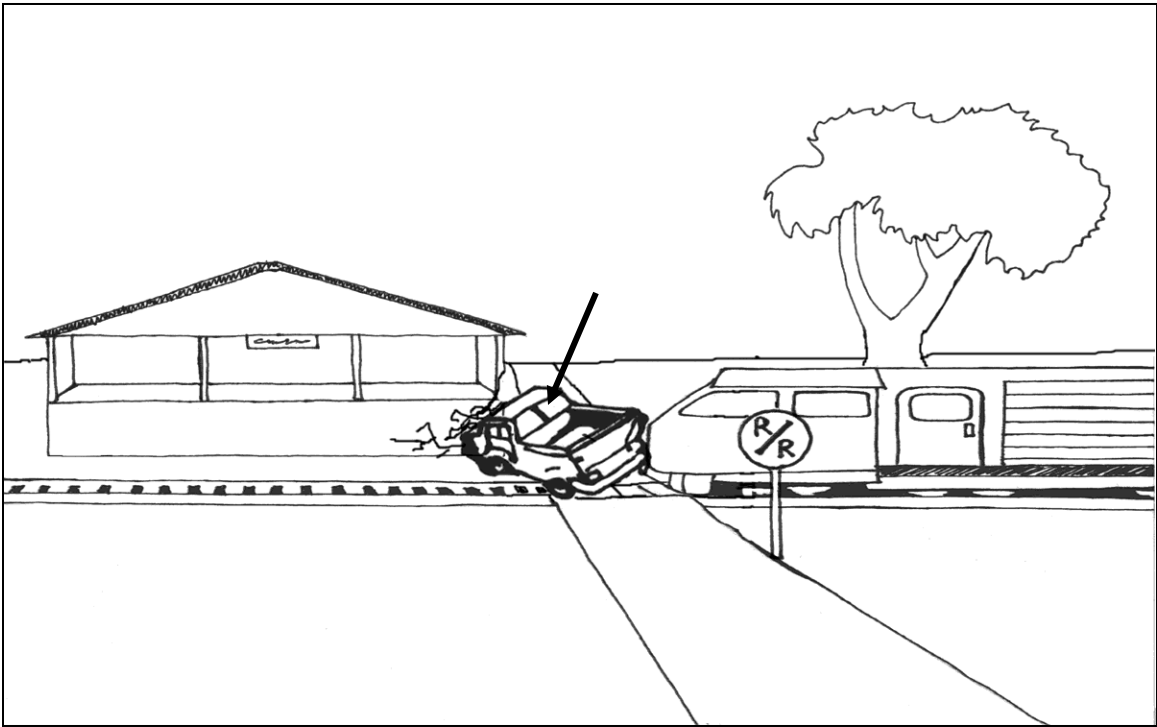

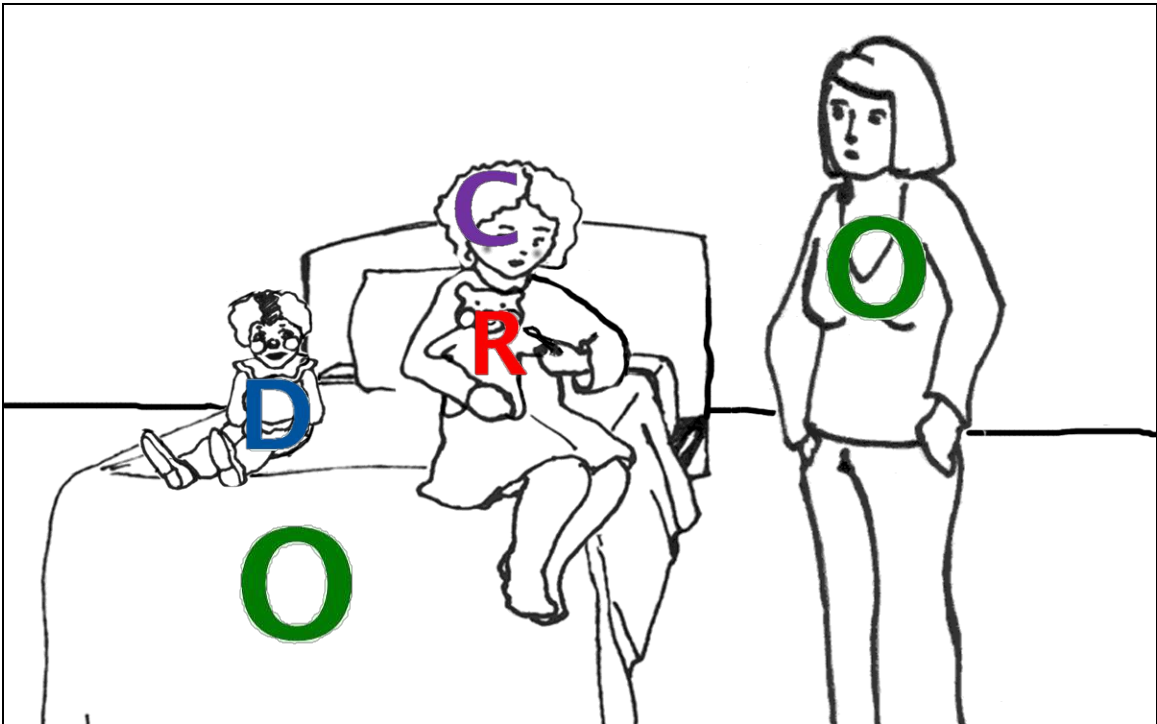

Problem 20-
1a

