

SAMPLE 01

Birthdate _____

Testing Date _____

Identification _____



SAMPLE 02

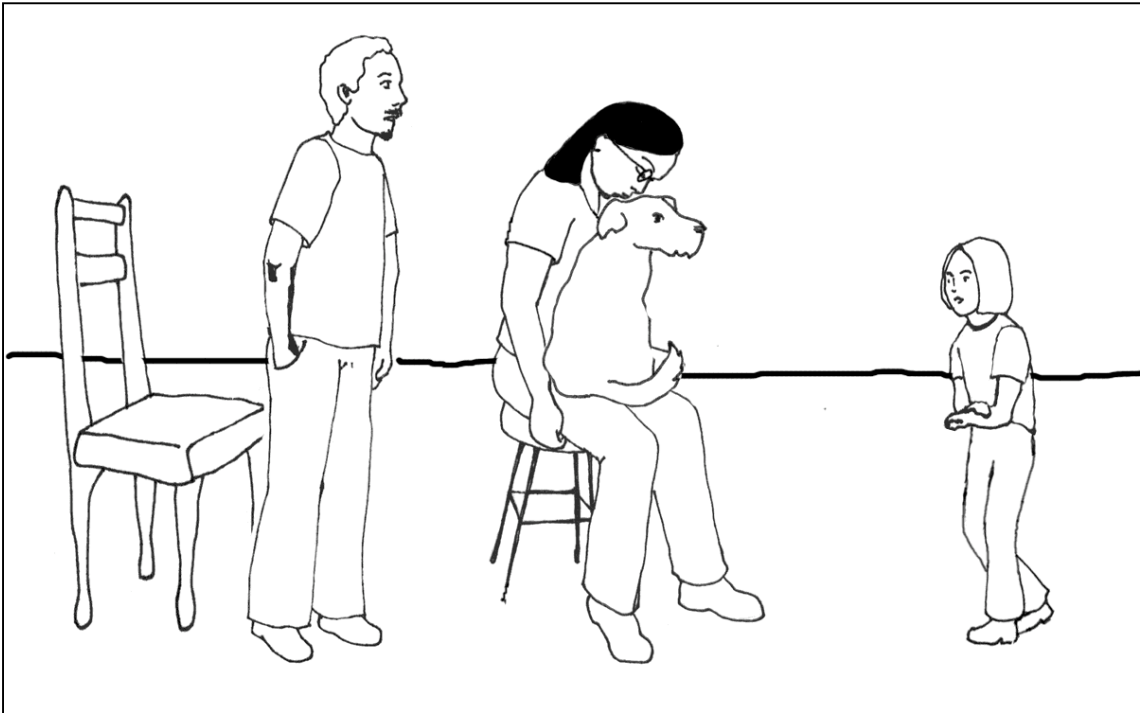
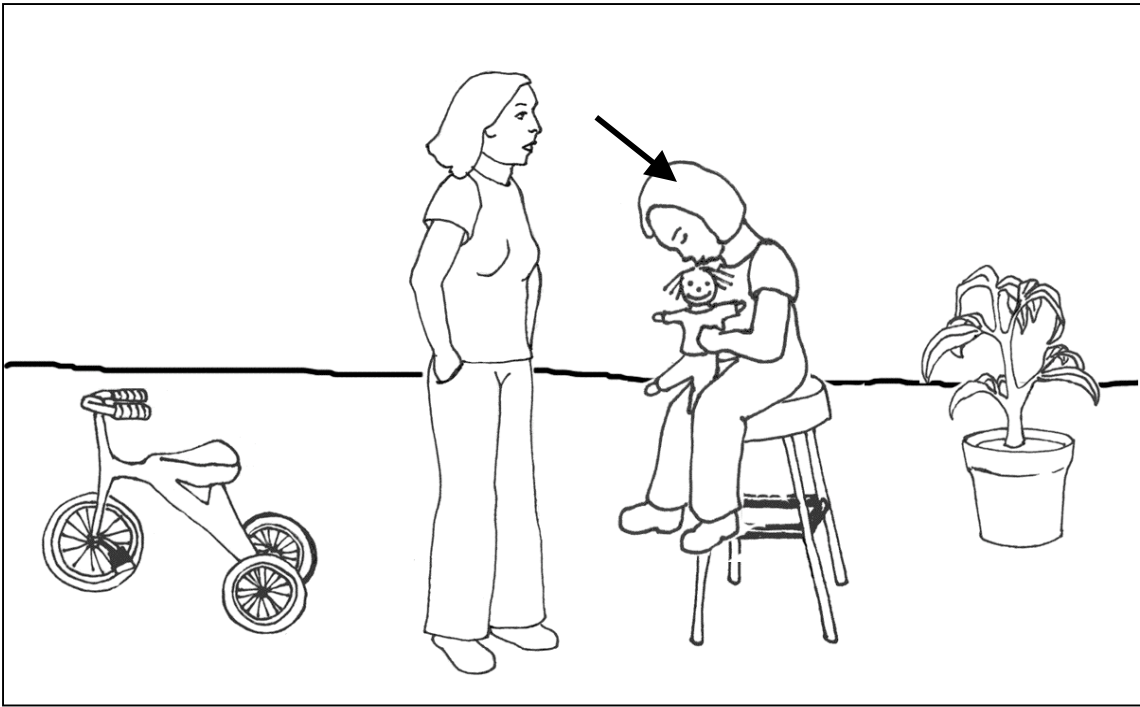

Problem 1-1a

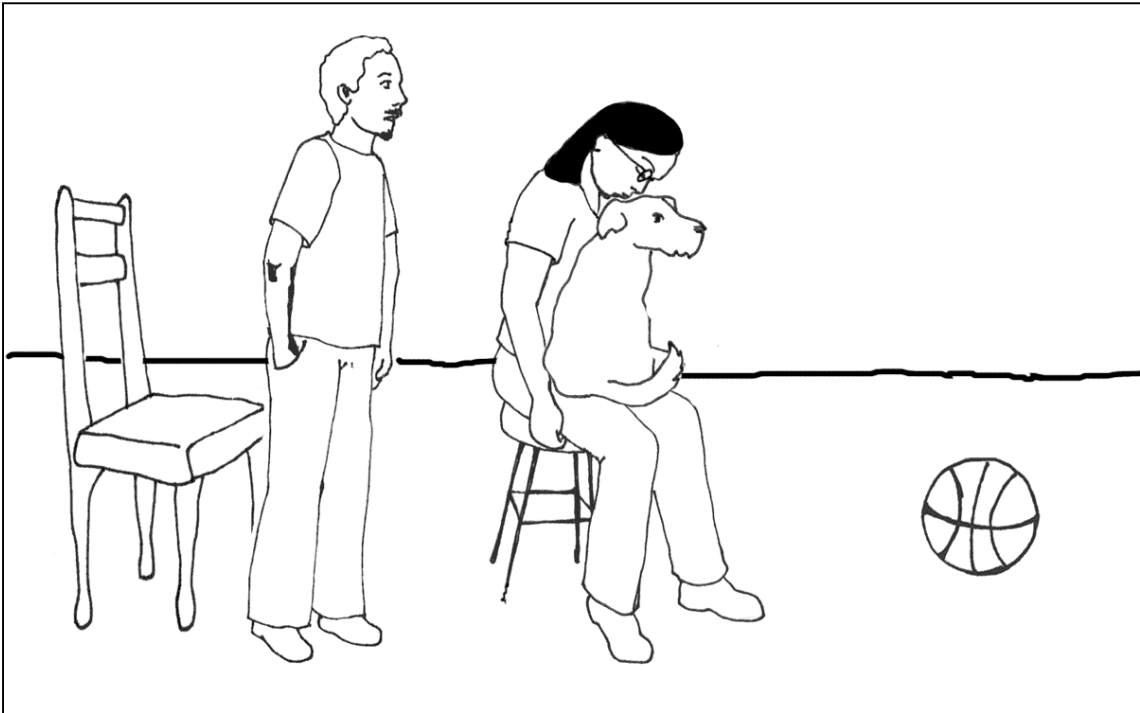
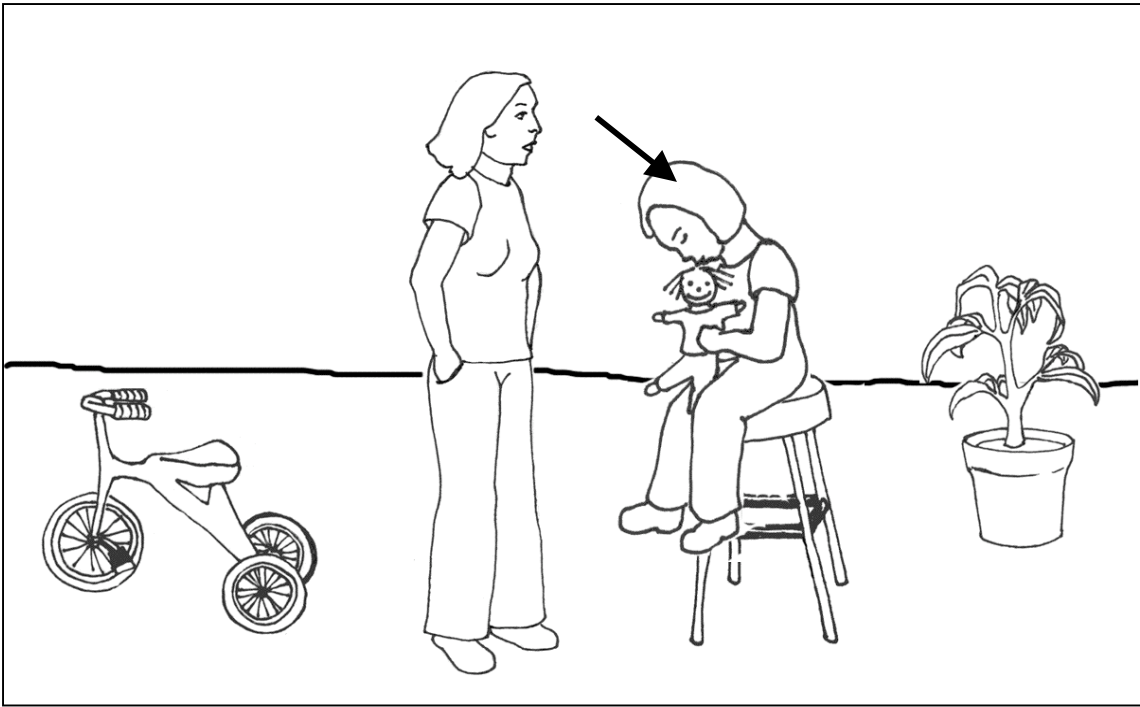

Problem 1-1b

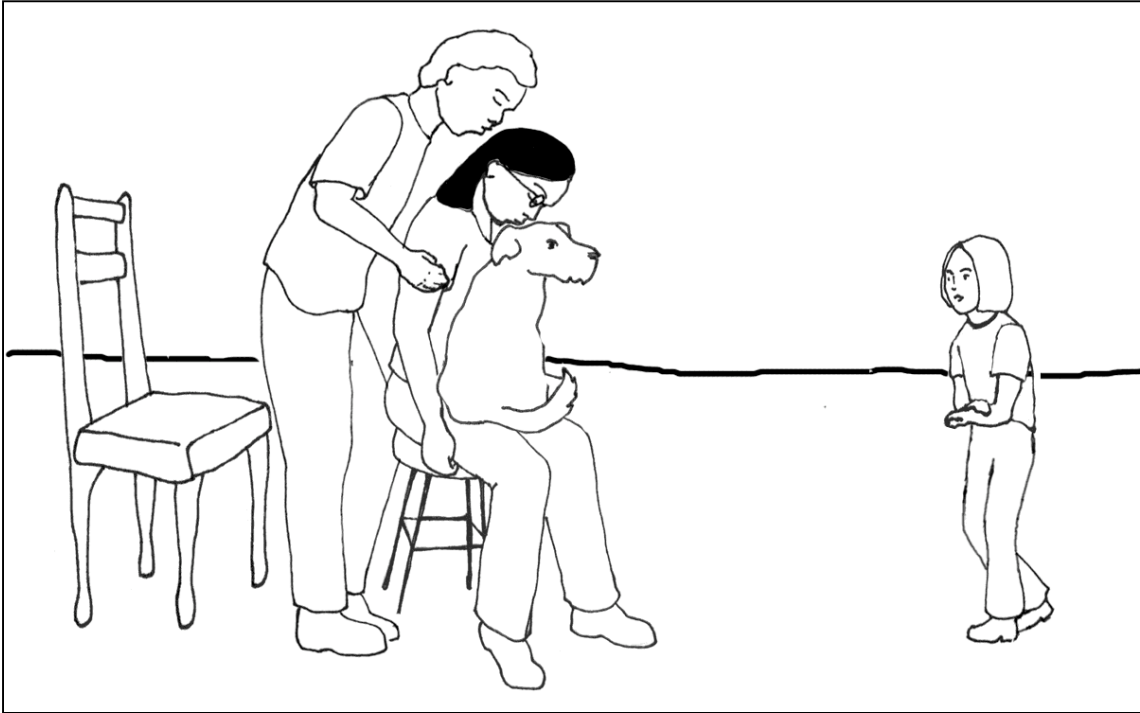
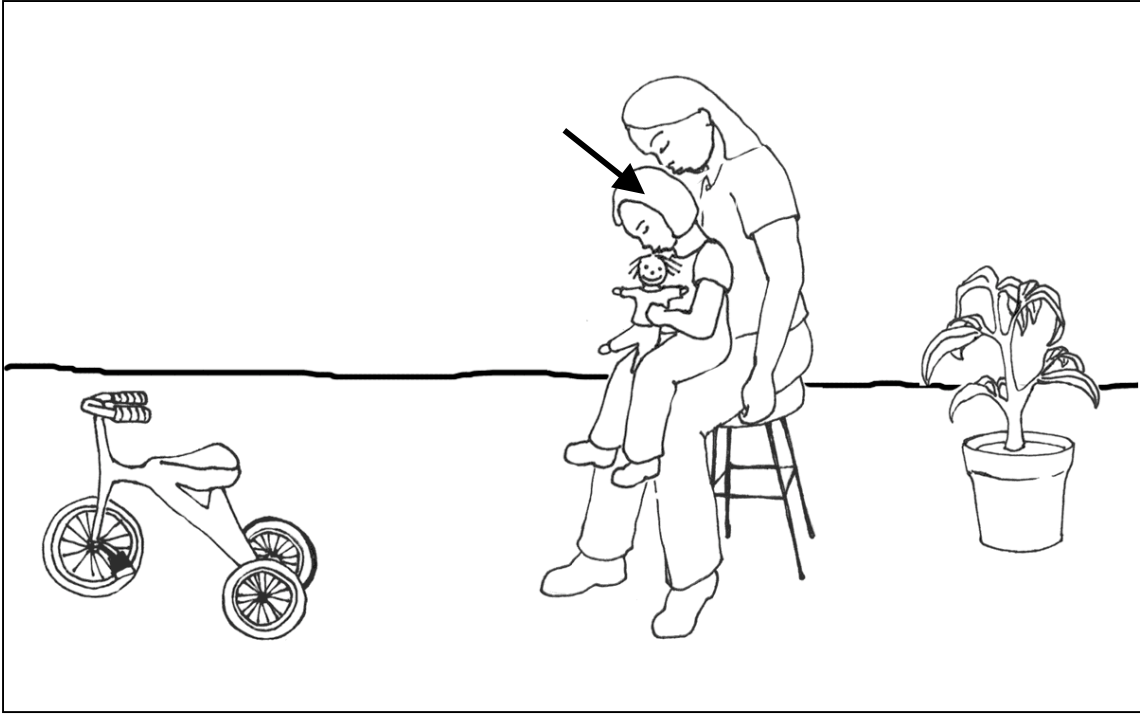

Problem 1-2a

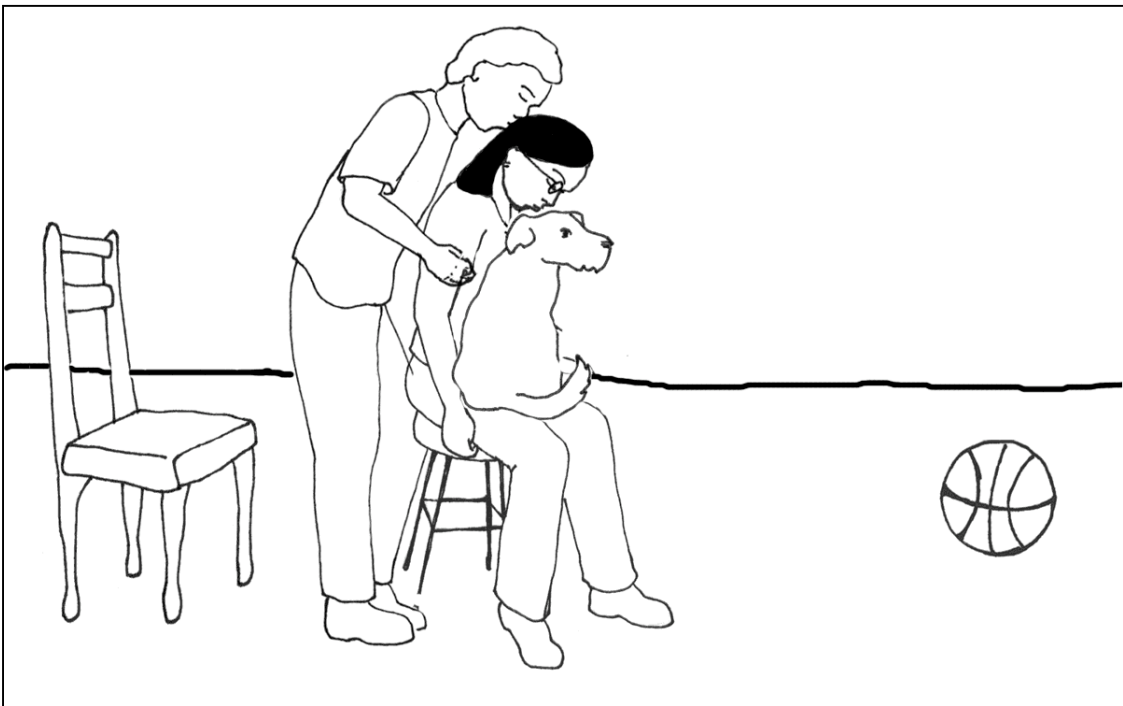
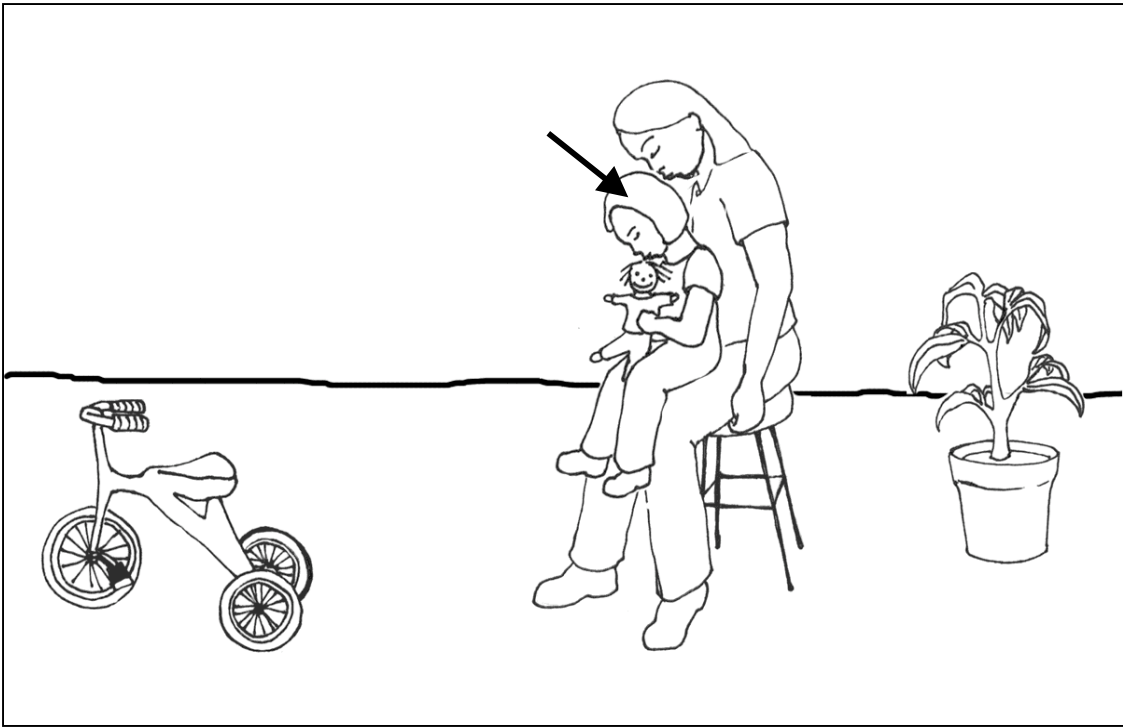

Problem 1-2b

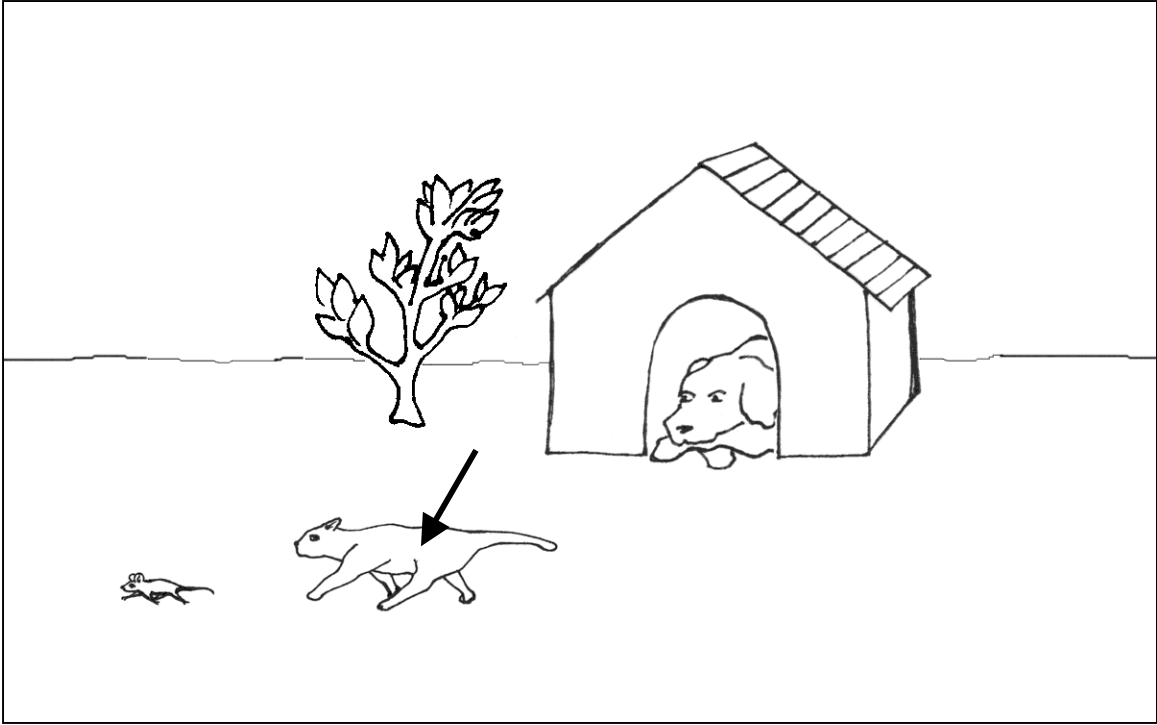

Problem 2-1a

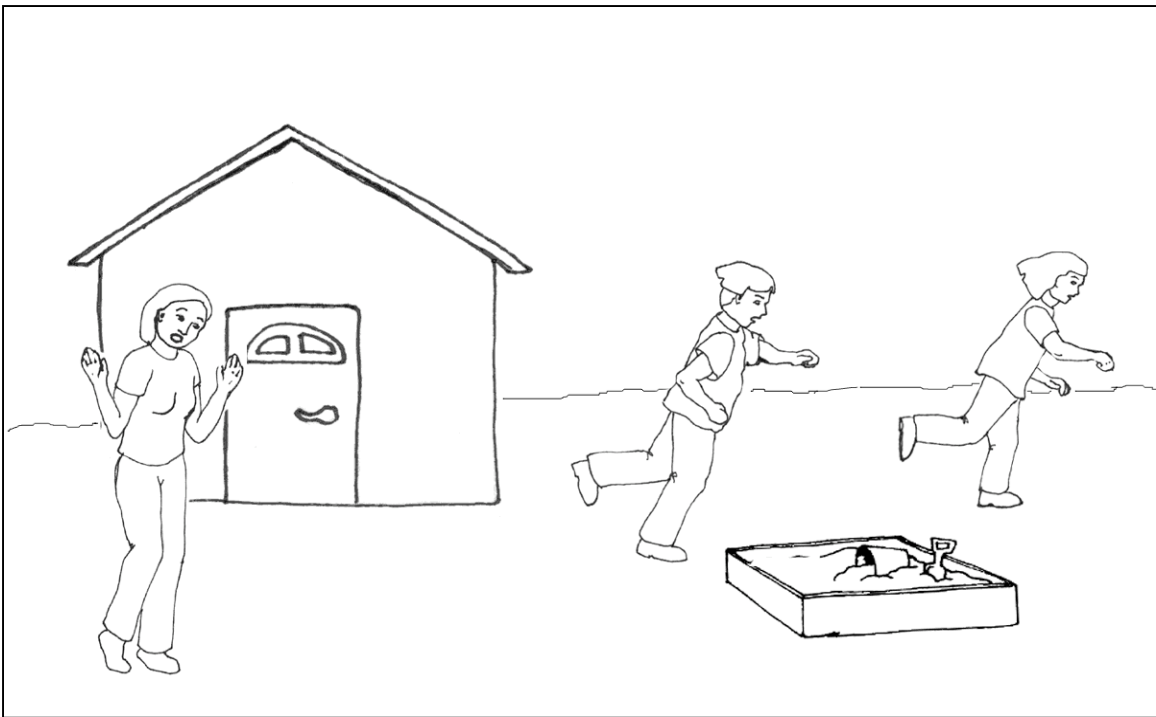
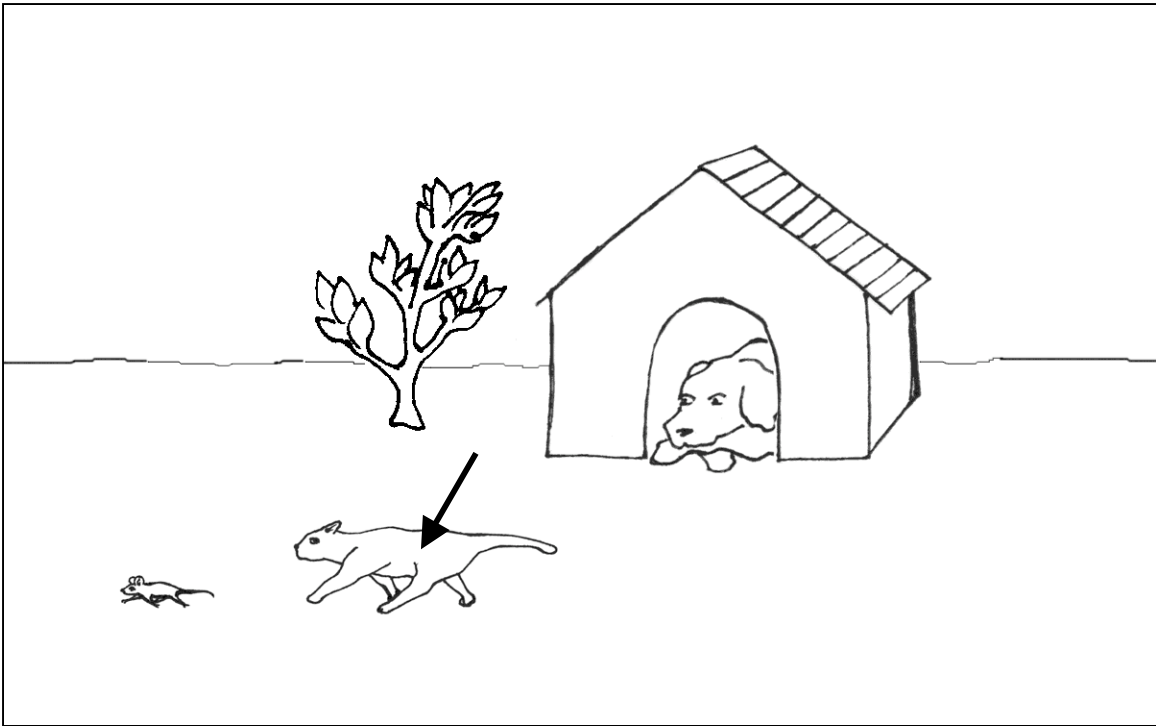

Problem 2-1b

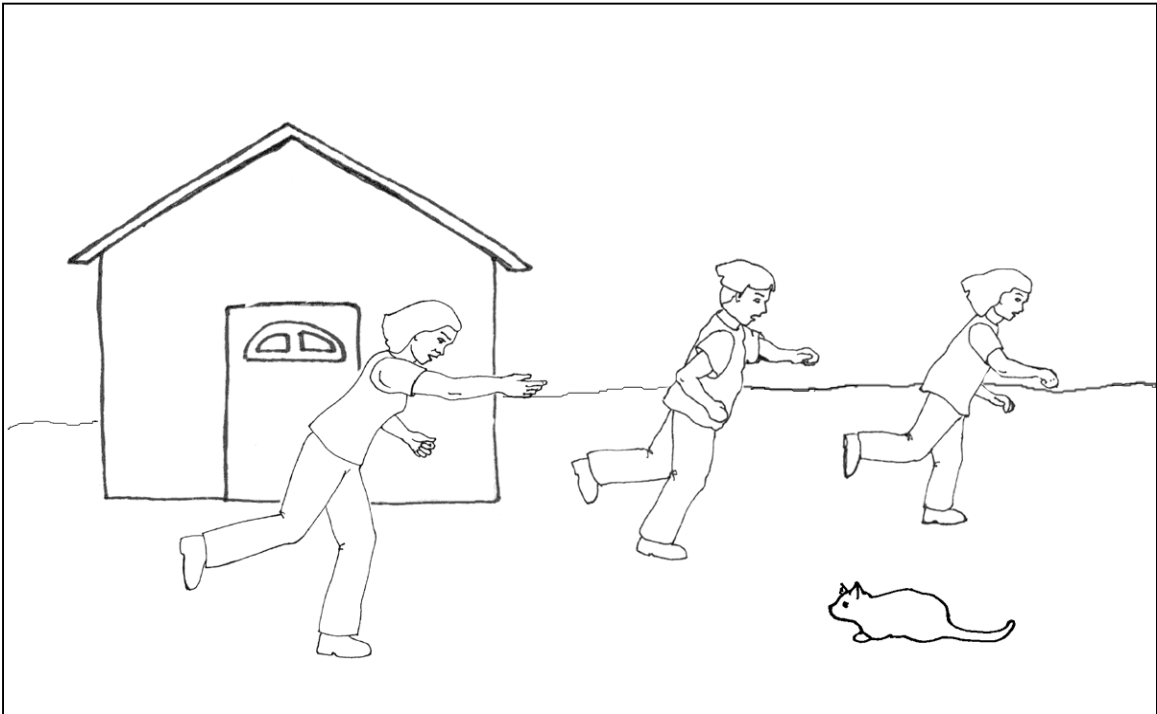
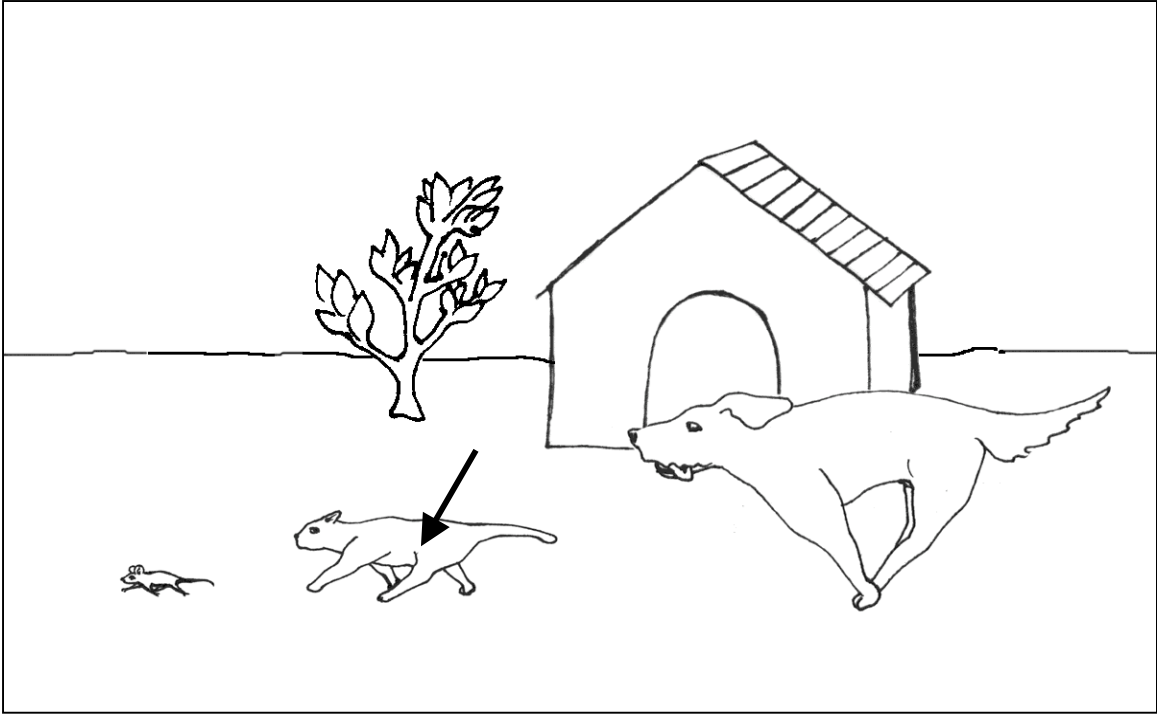

Problem 2-2a

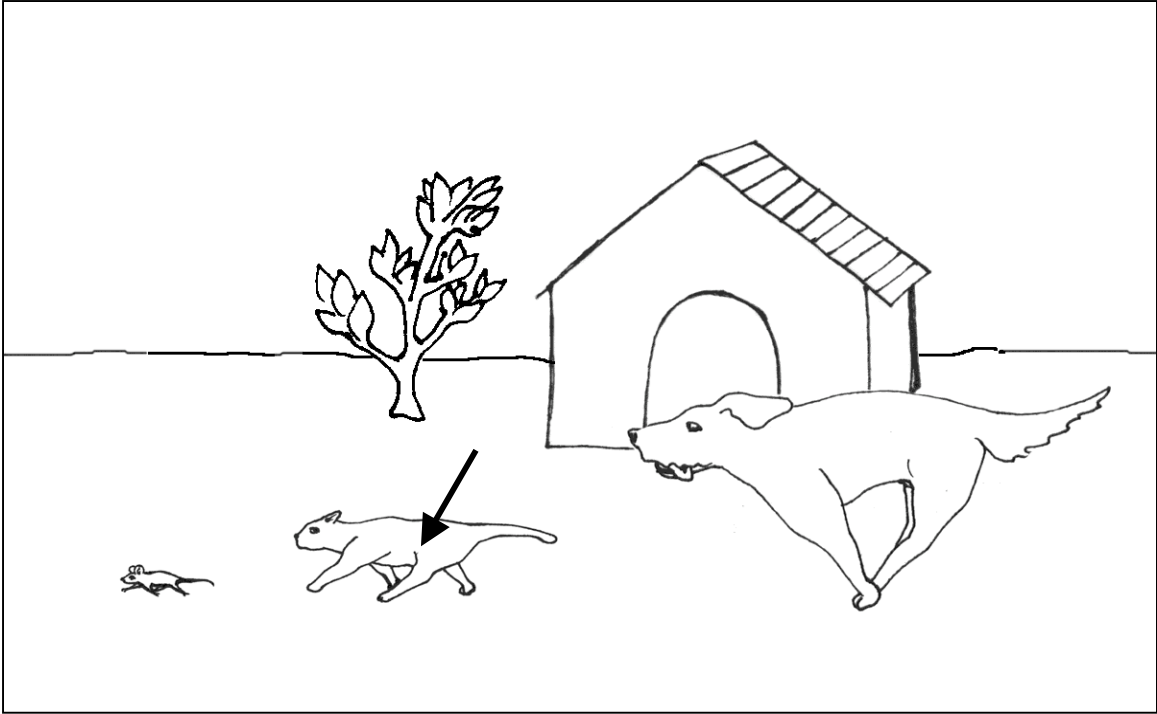

Problem 2-2b

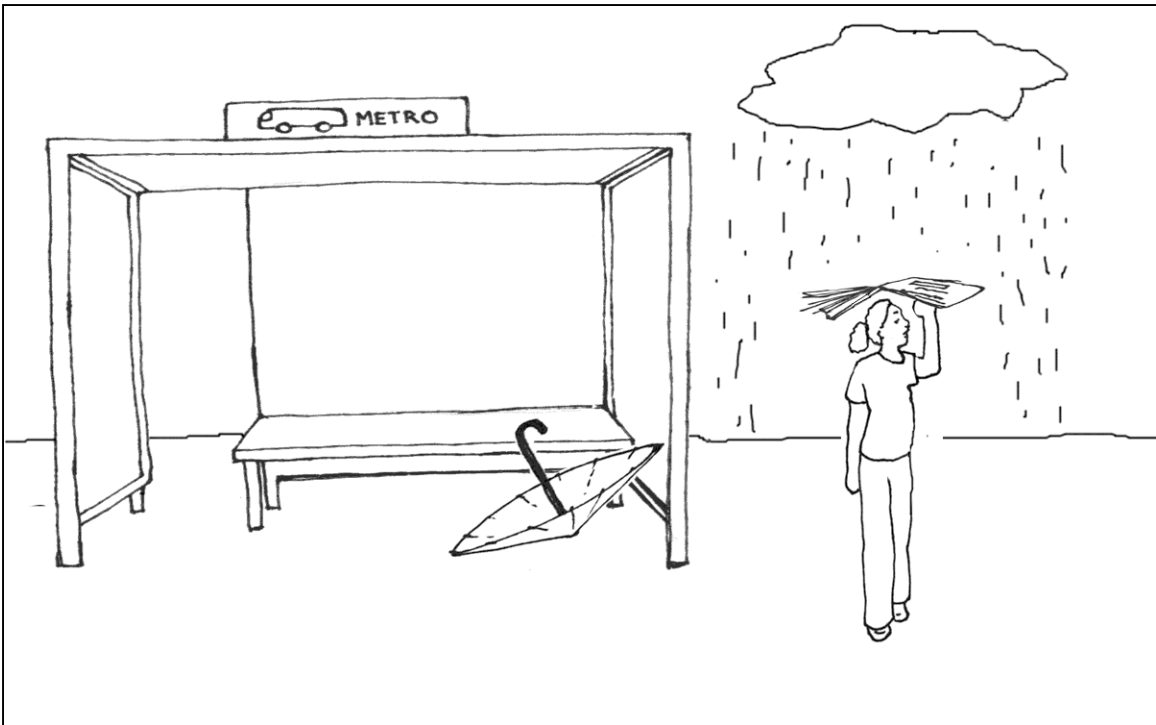
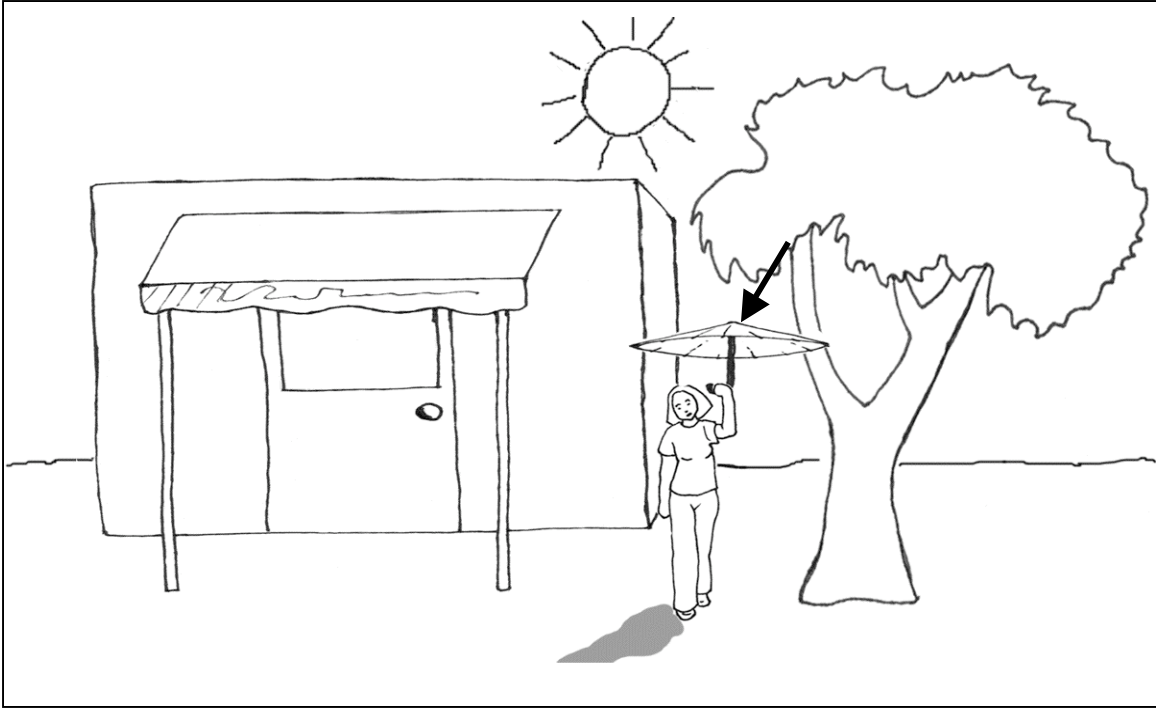

Problem 3-1a

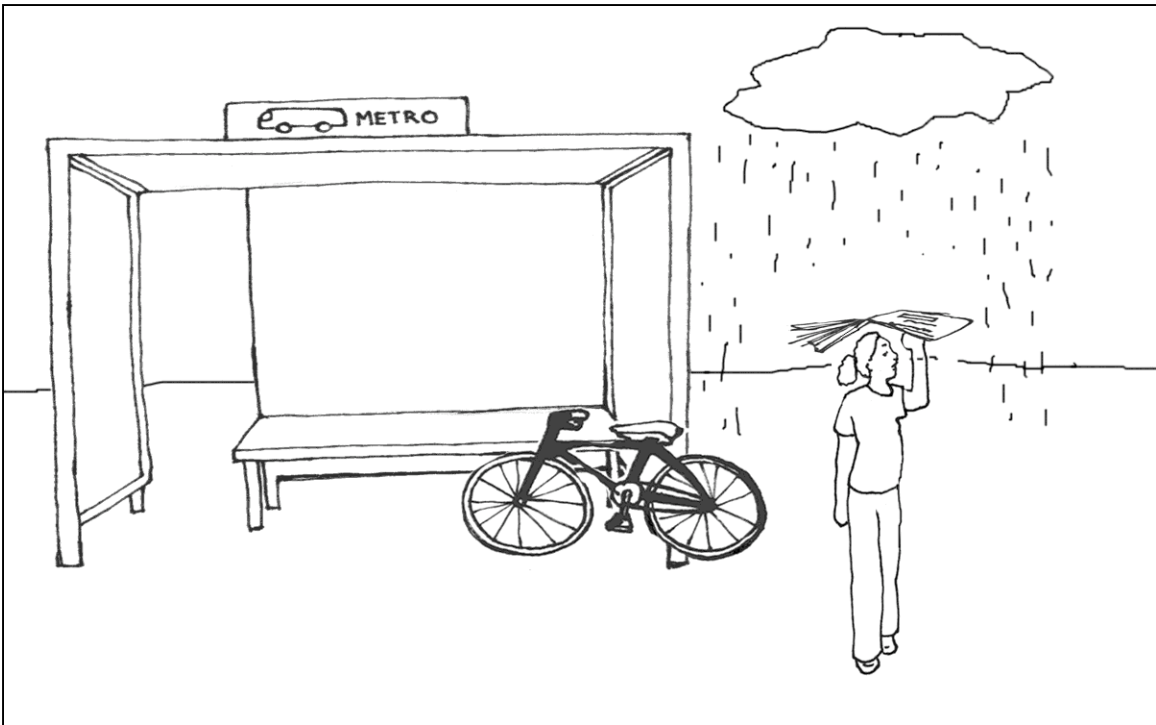
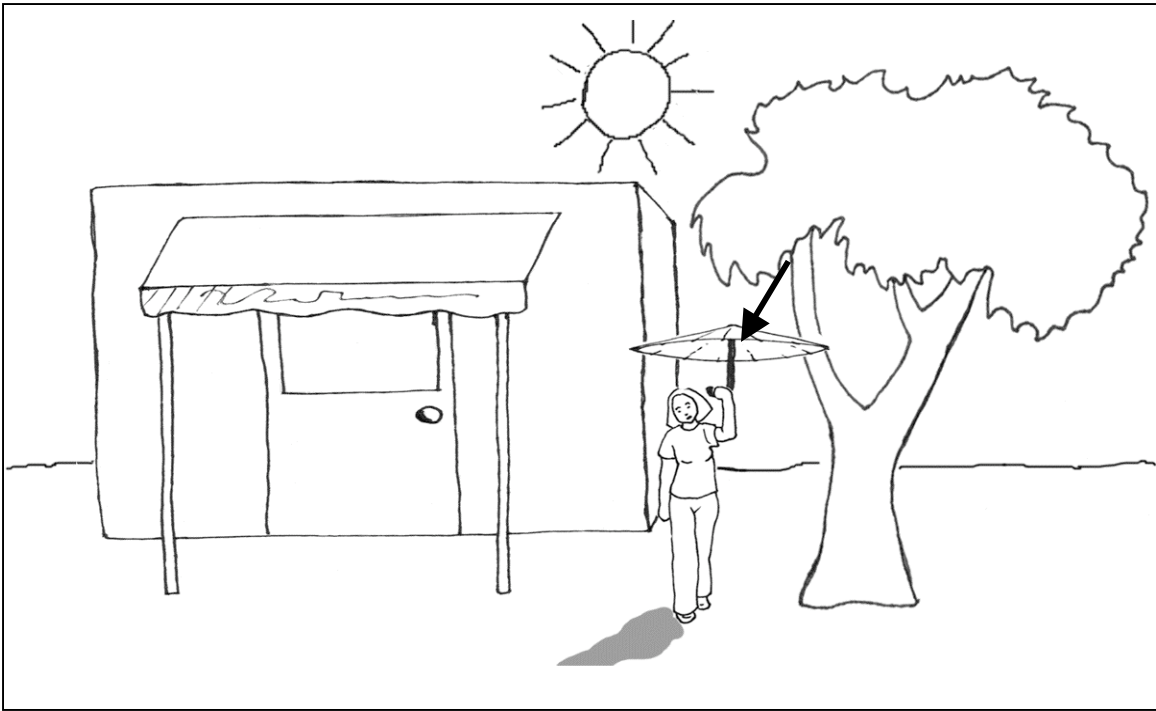

Problem 3-1b

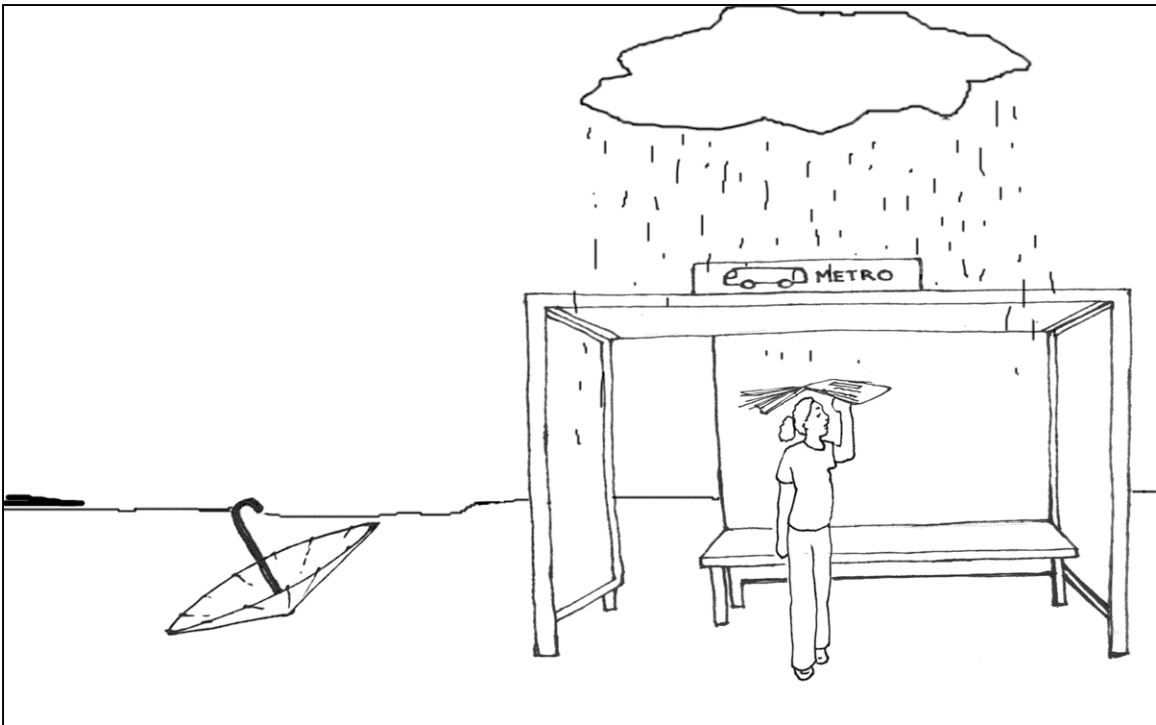
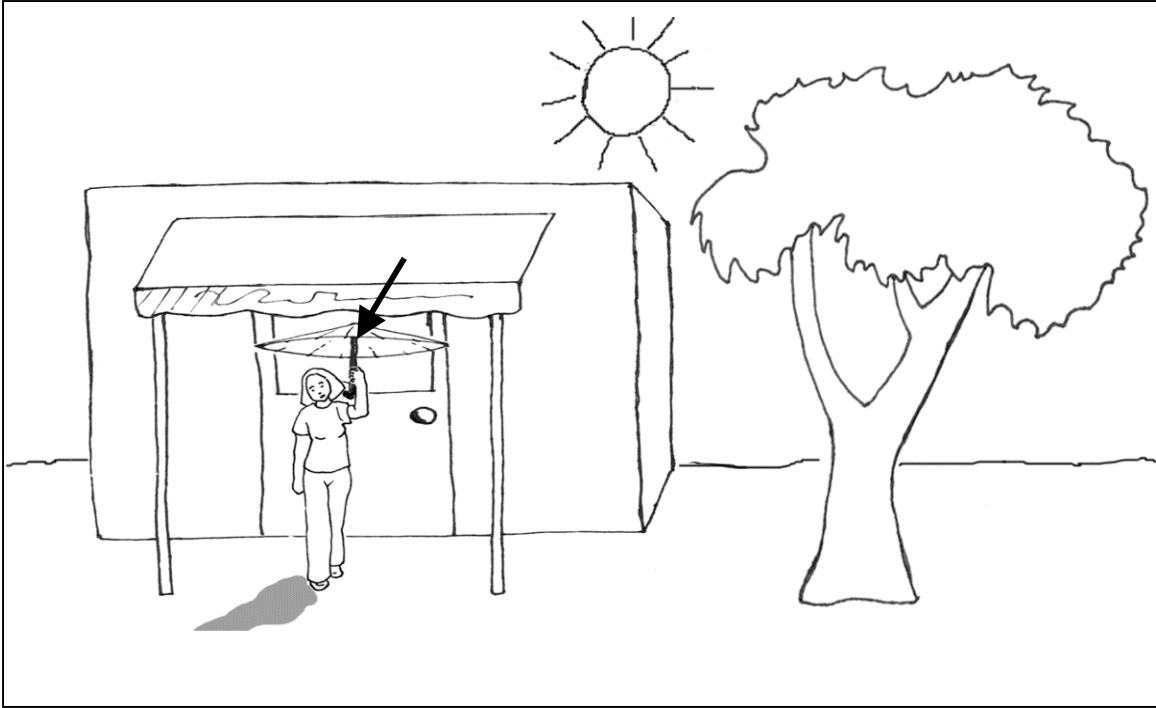

Problem 3-2a

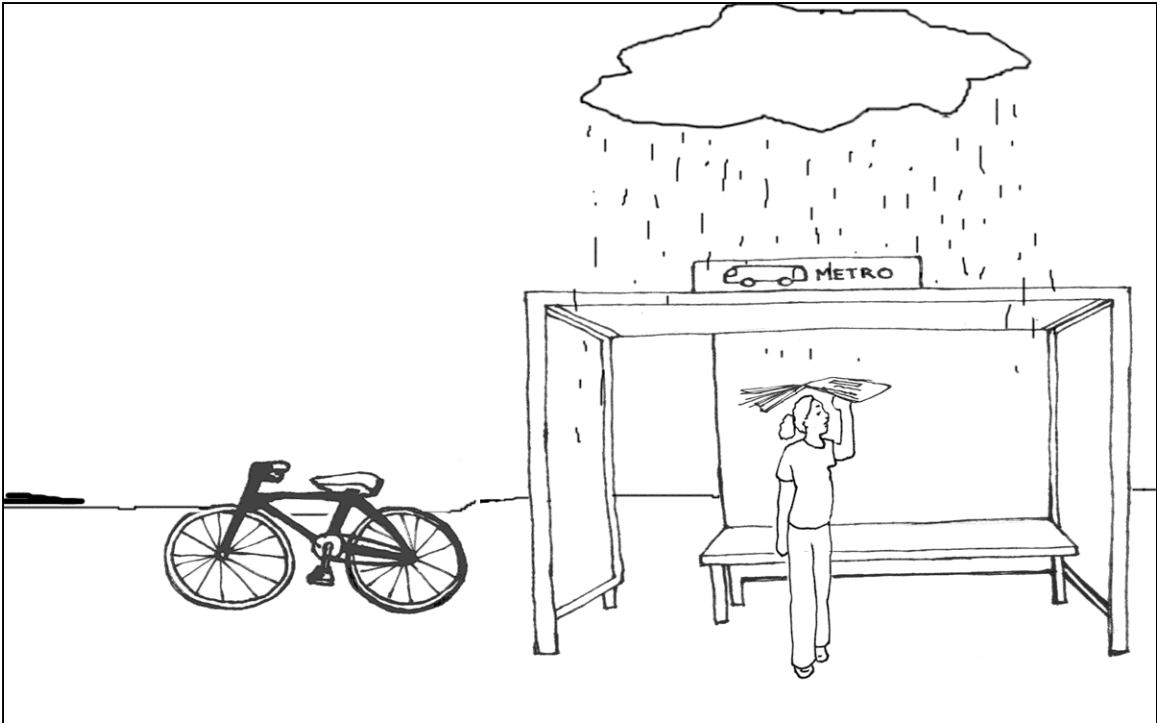
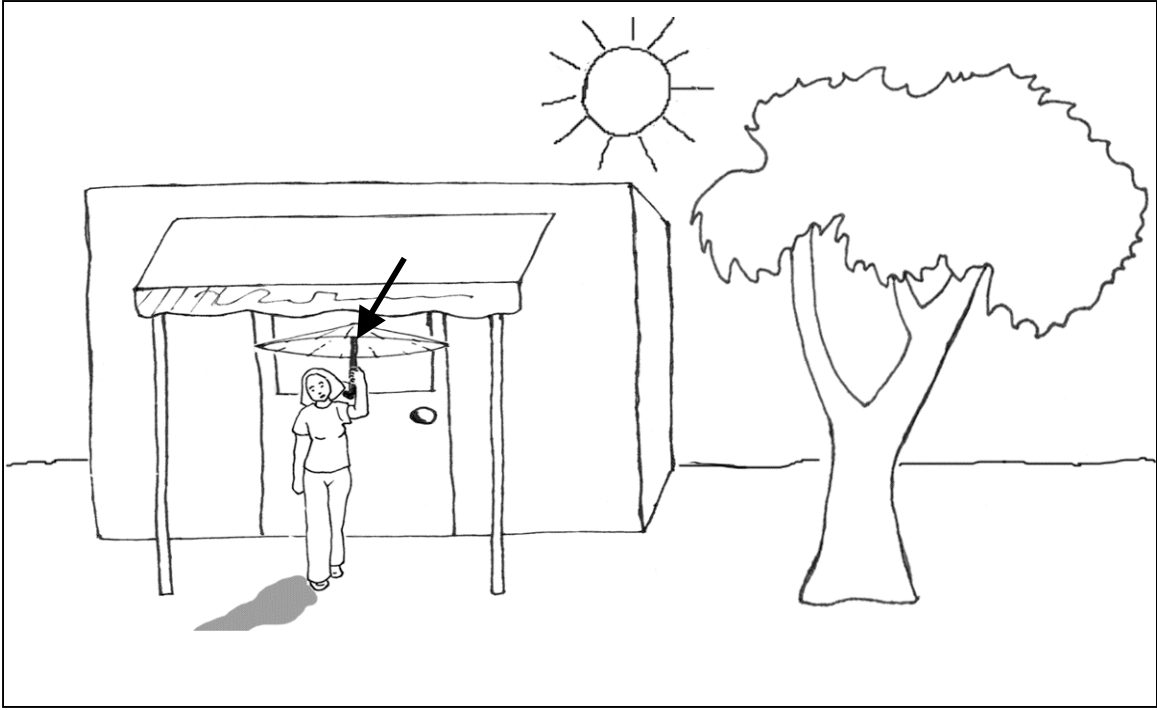

Problem 3-2b

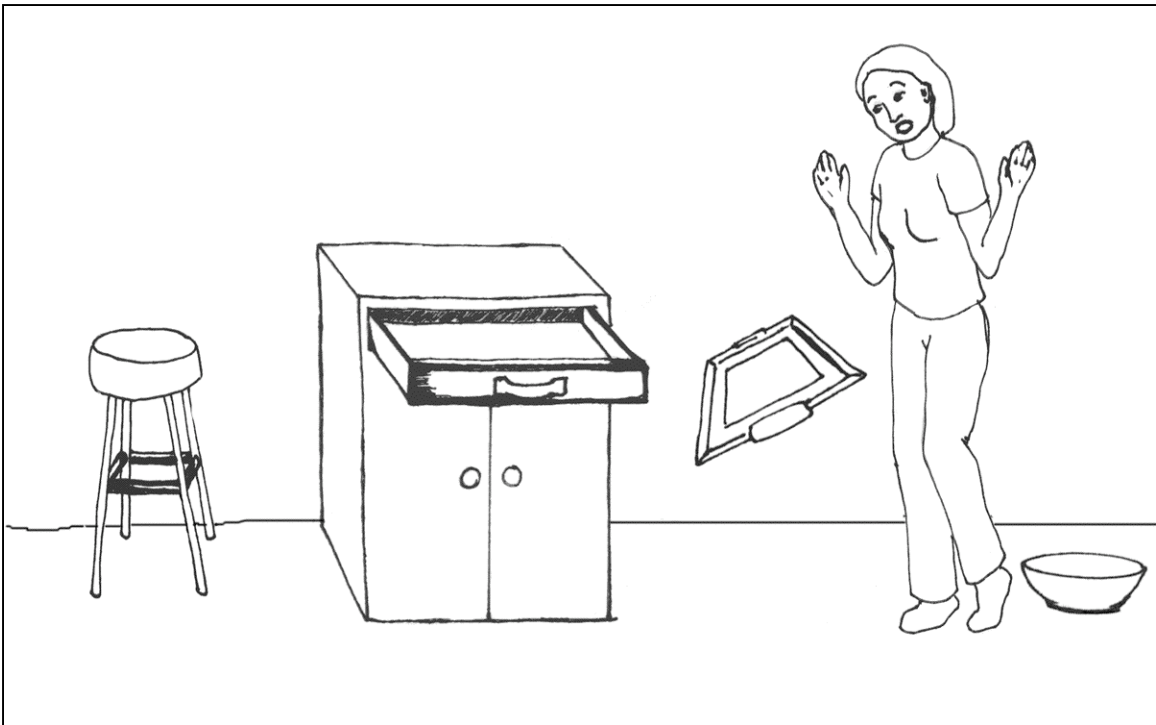
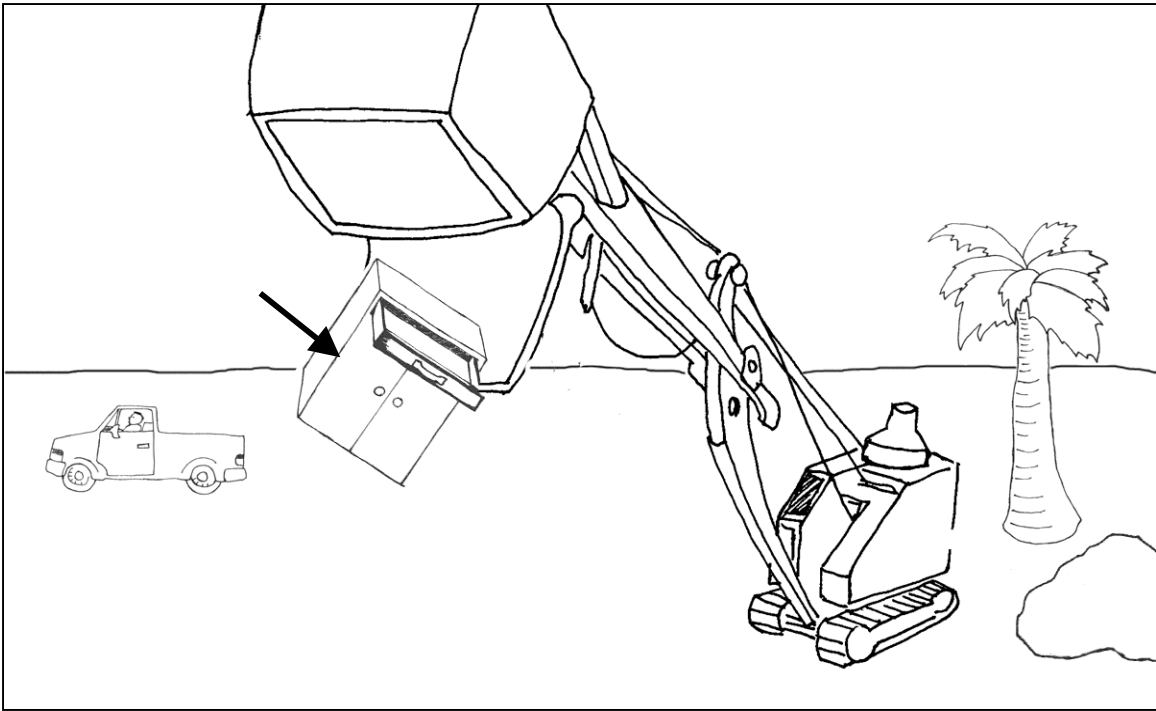

Problem 4-1a

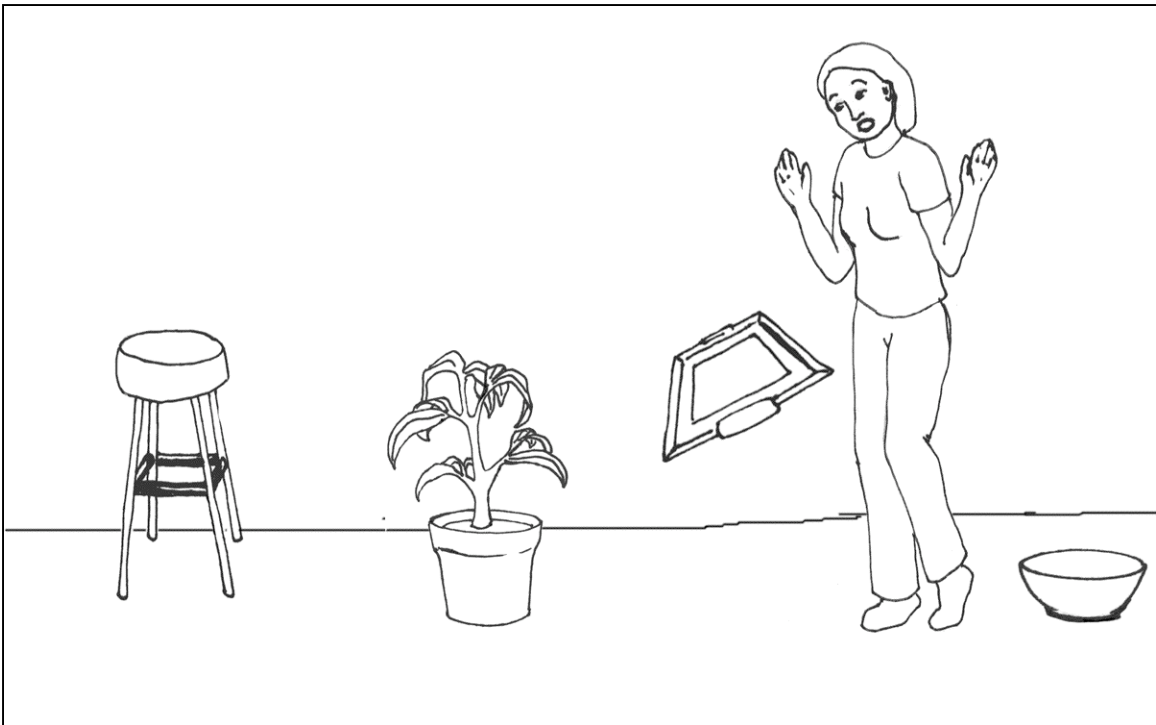
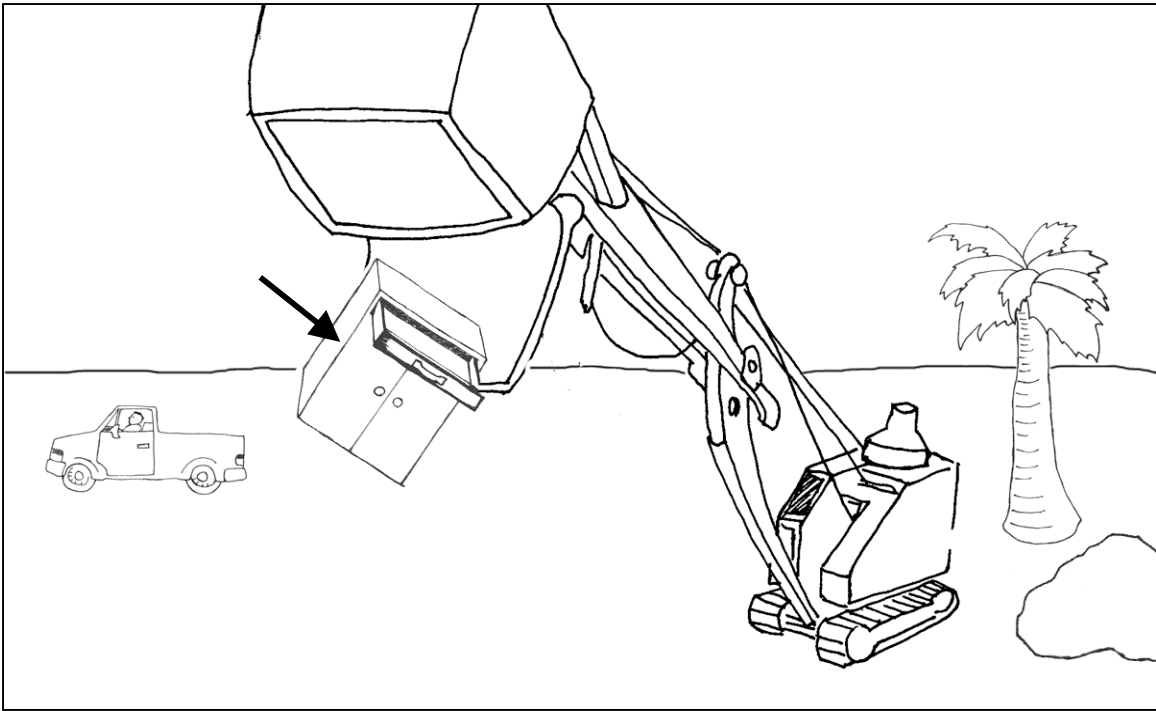

Problem 4-1b

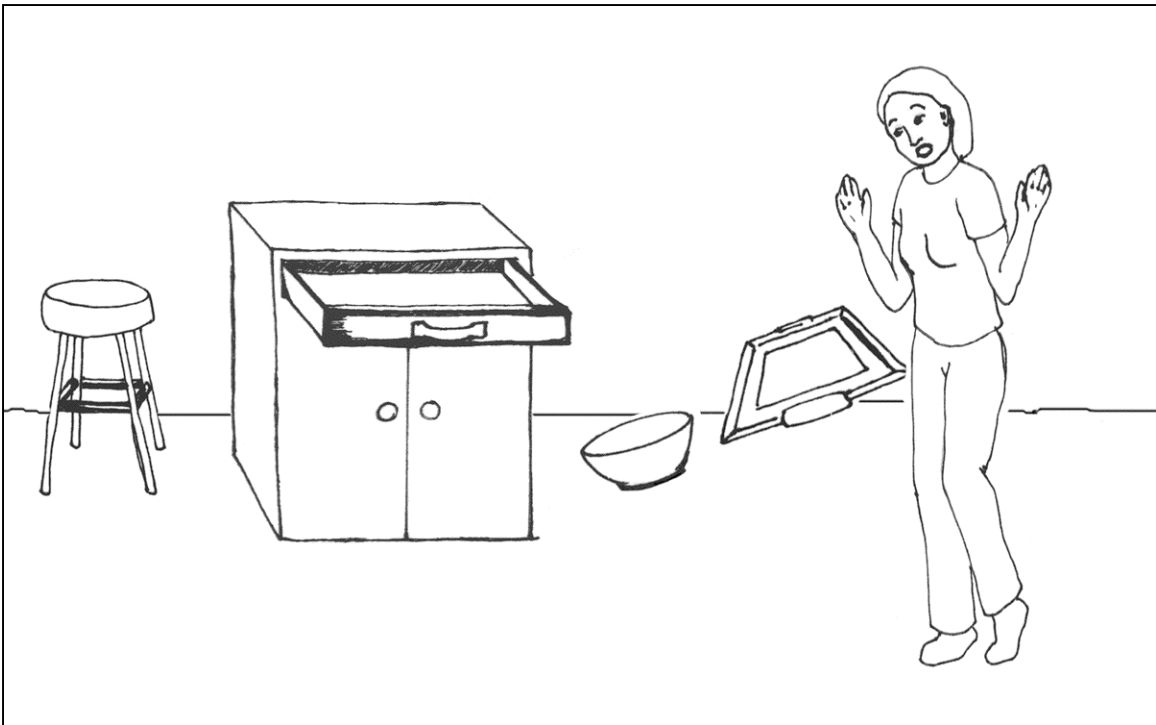
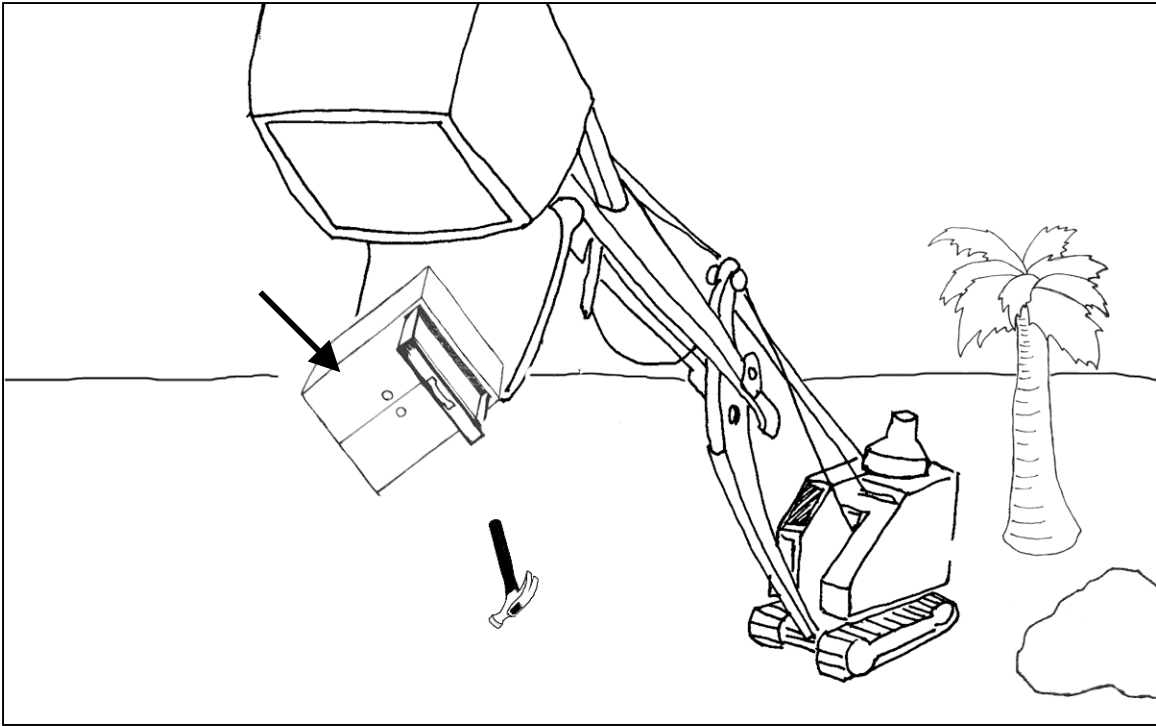

Problem 4-2a

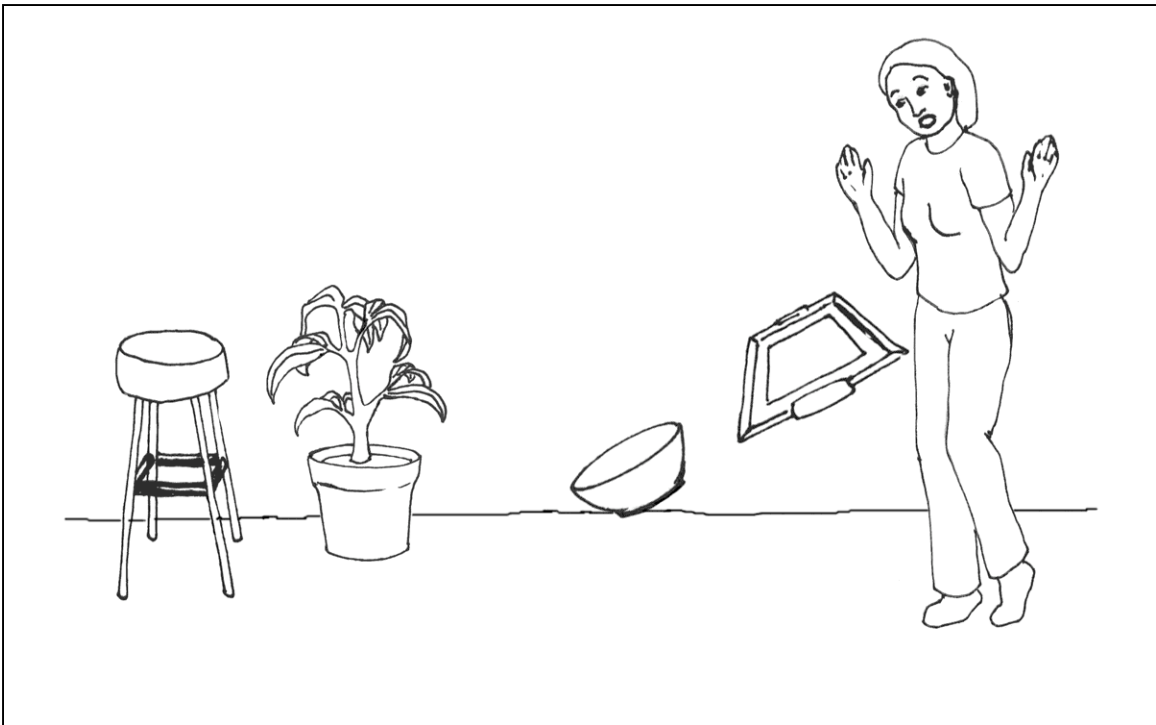
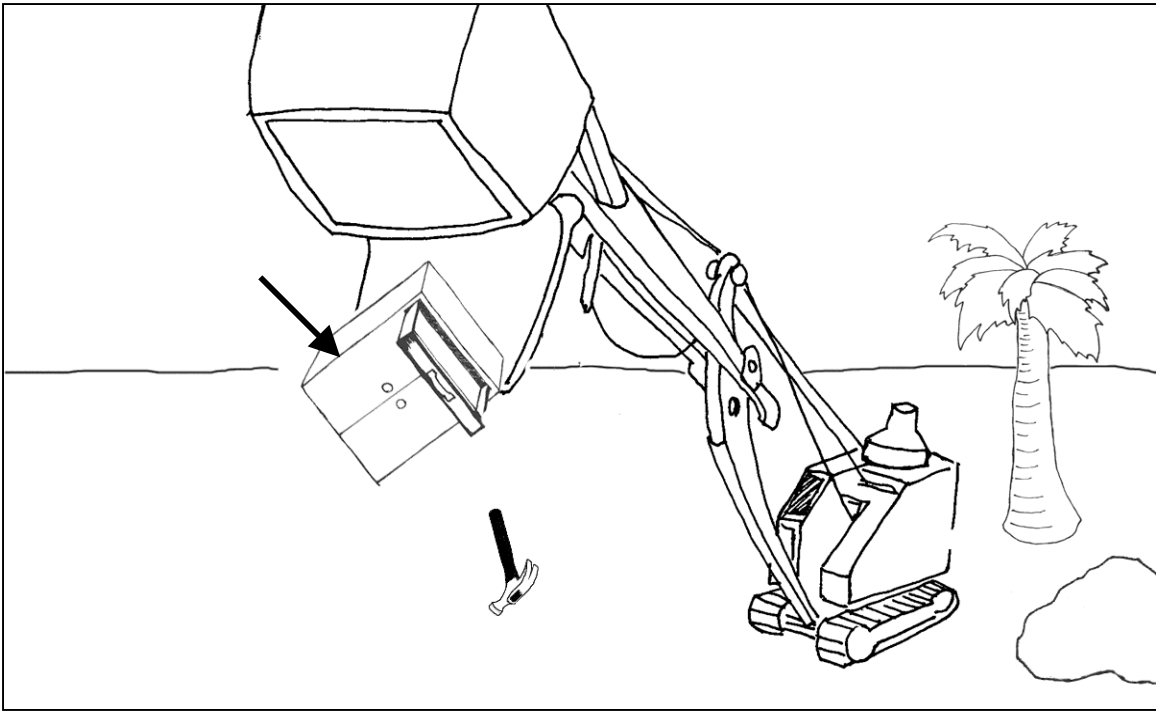

Problem 4-2b

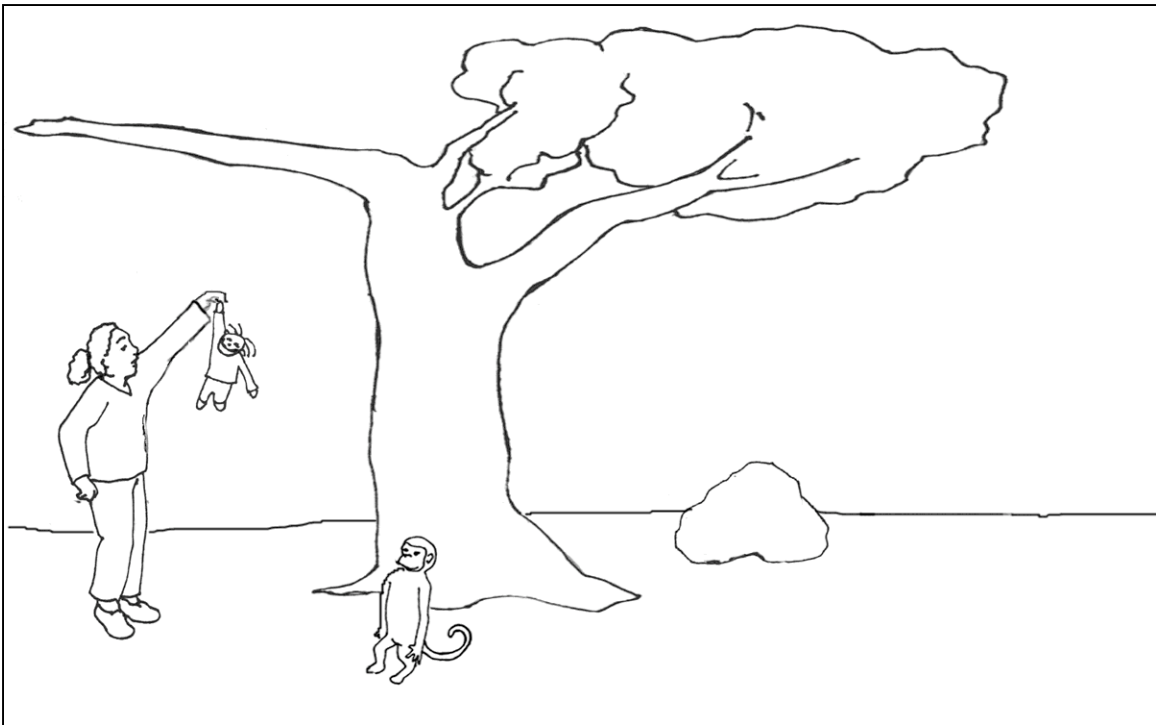
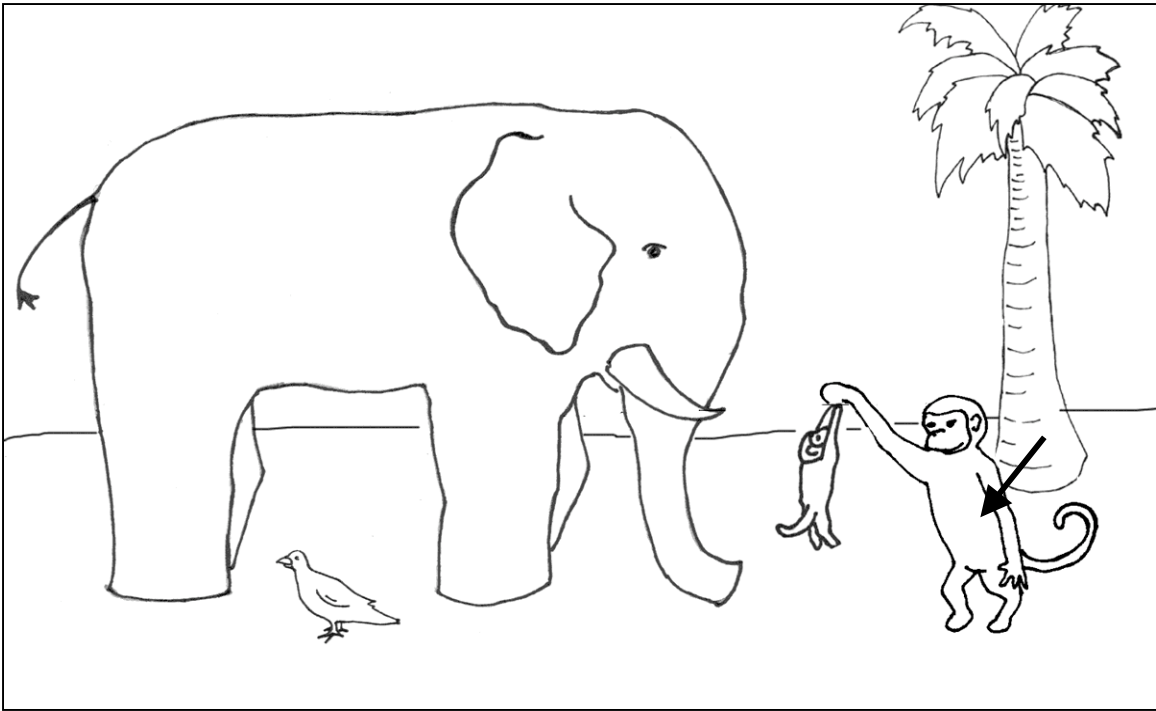

Problem 5-1a

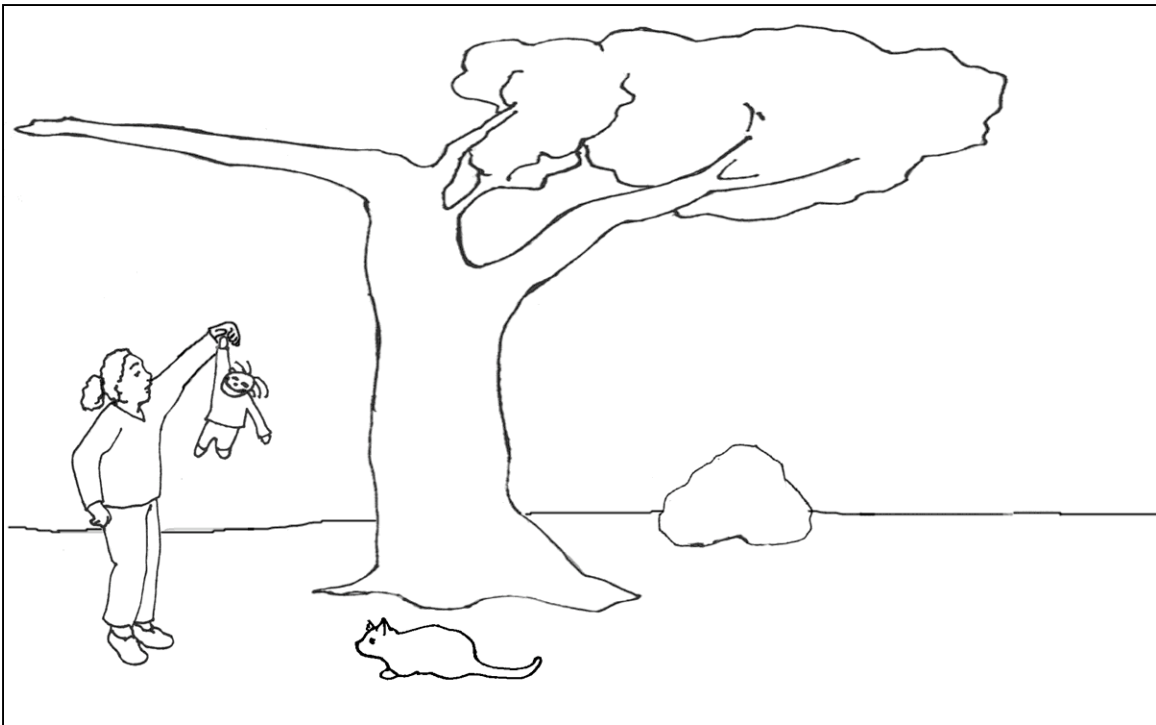
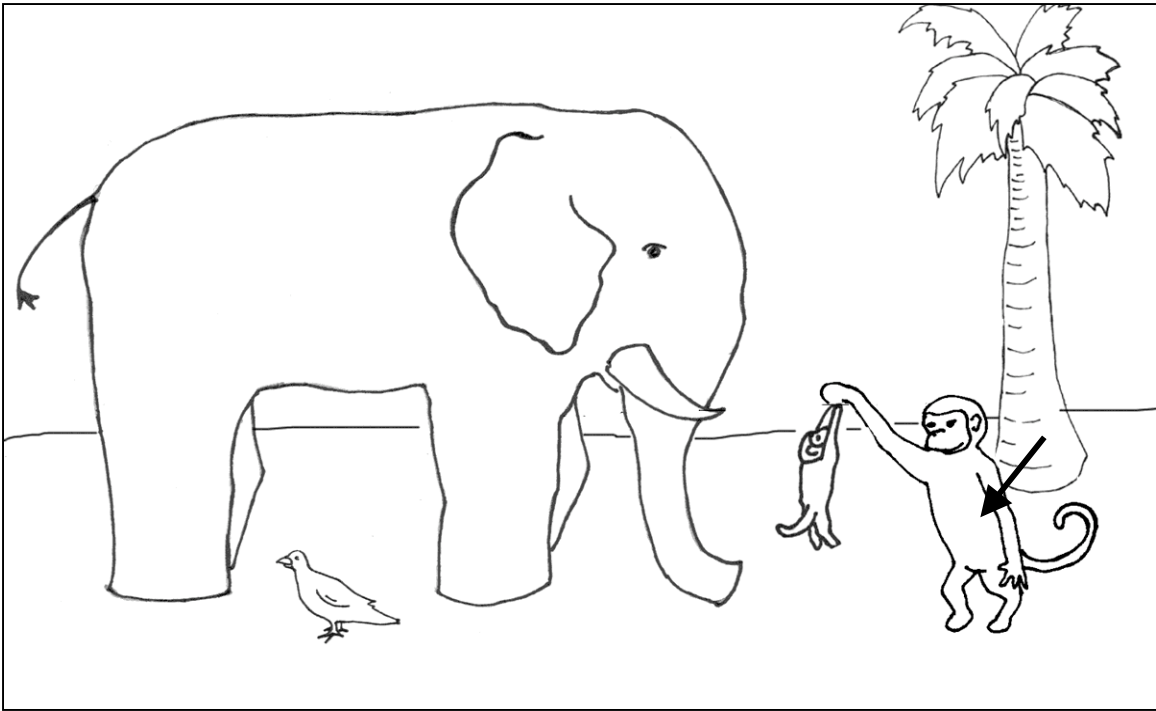

Problem 5-1b

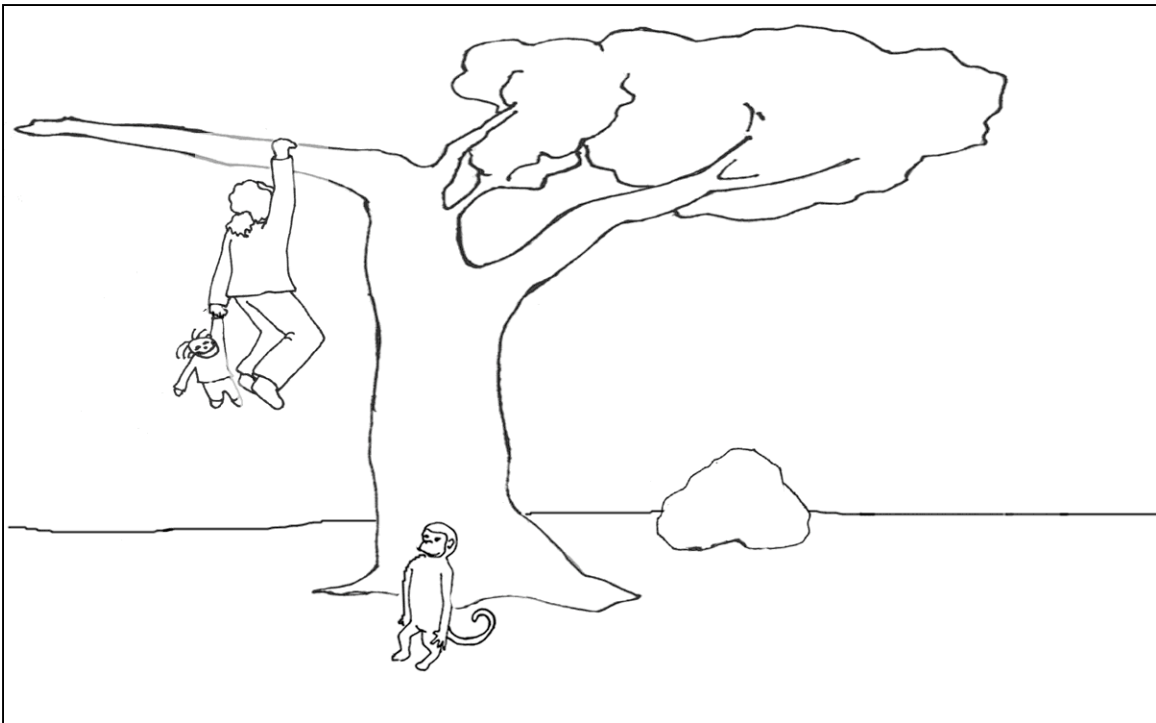
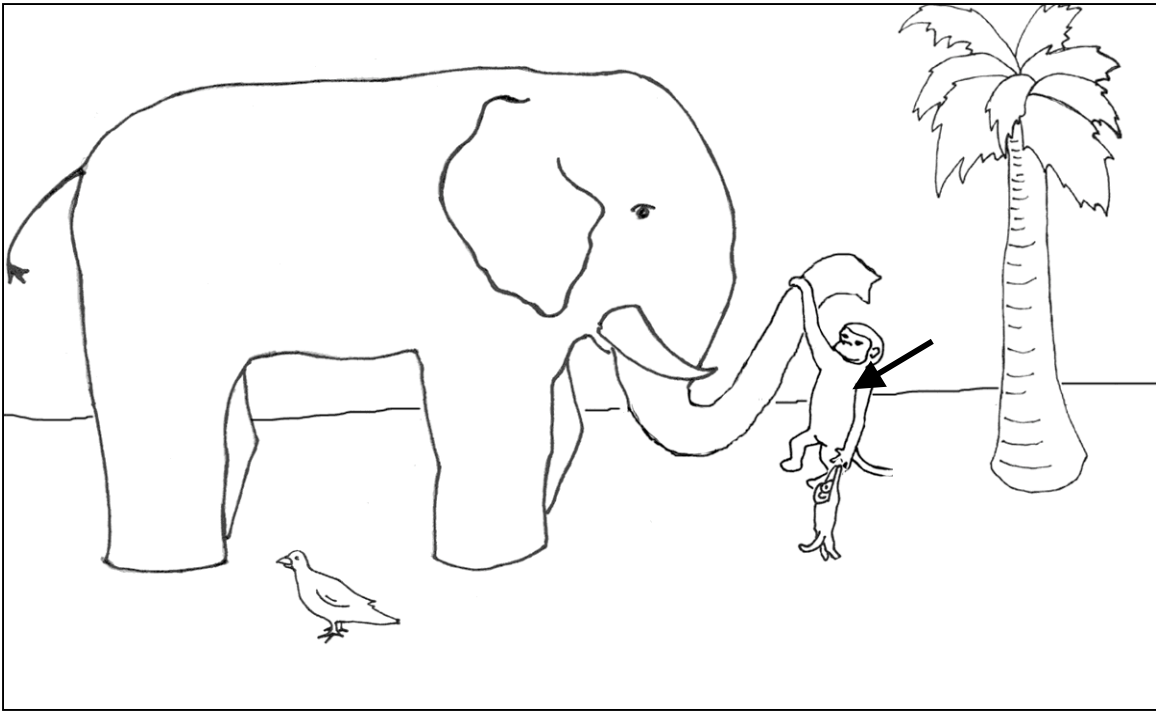

Problem 5-2a

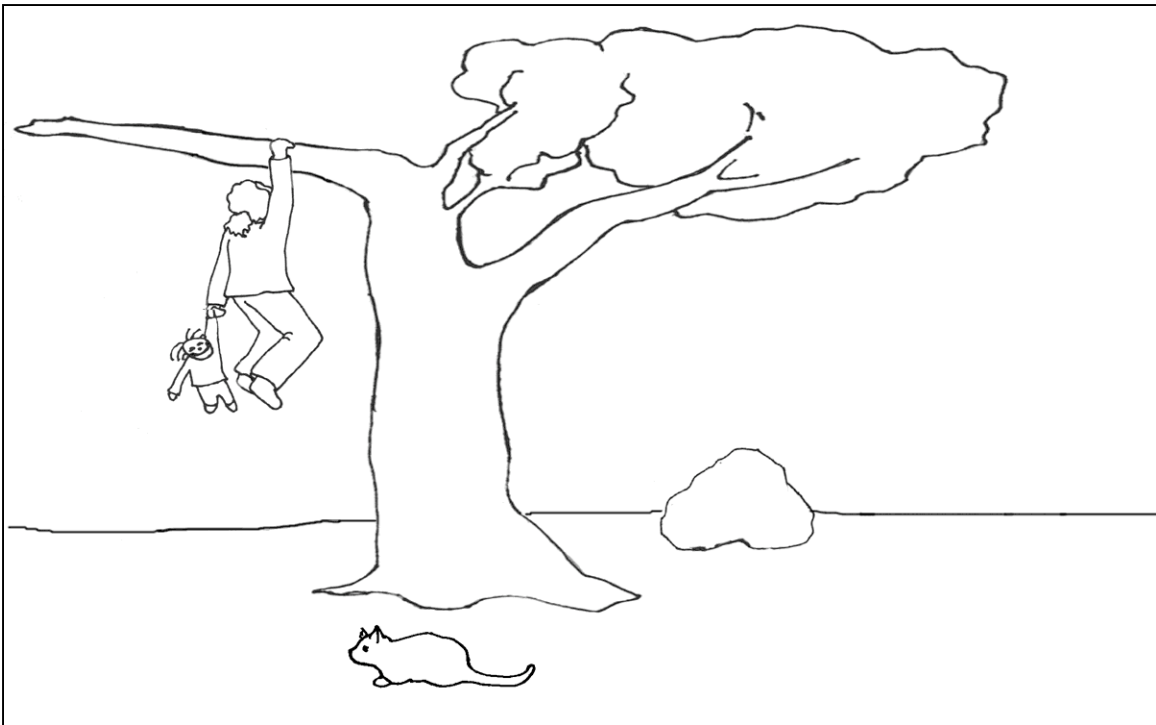
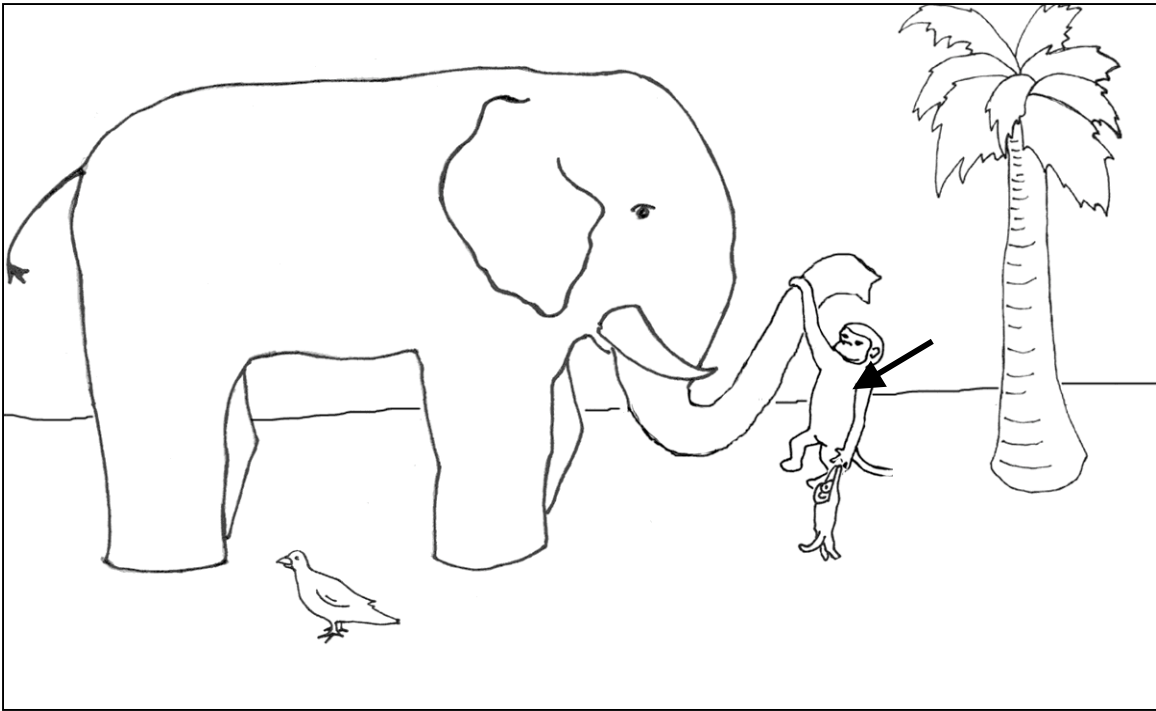

Problem 5-2b

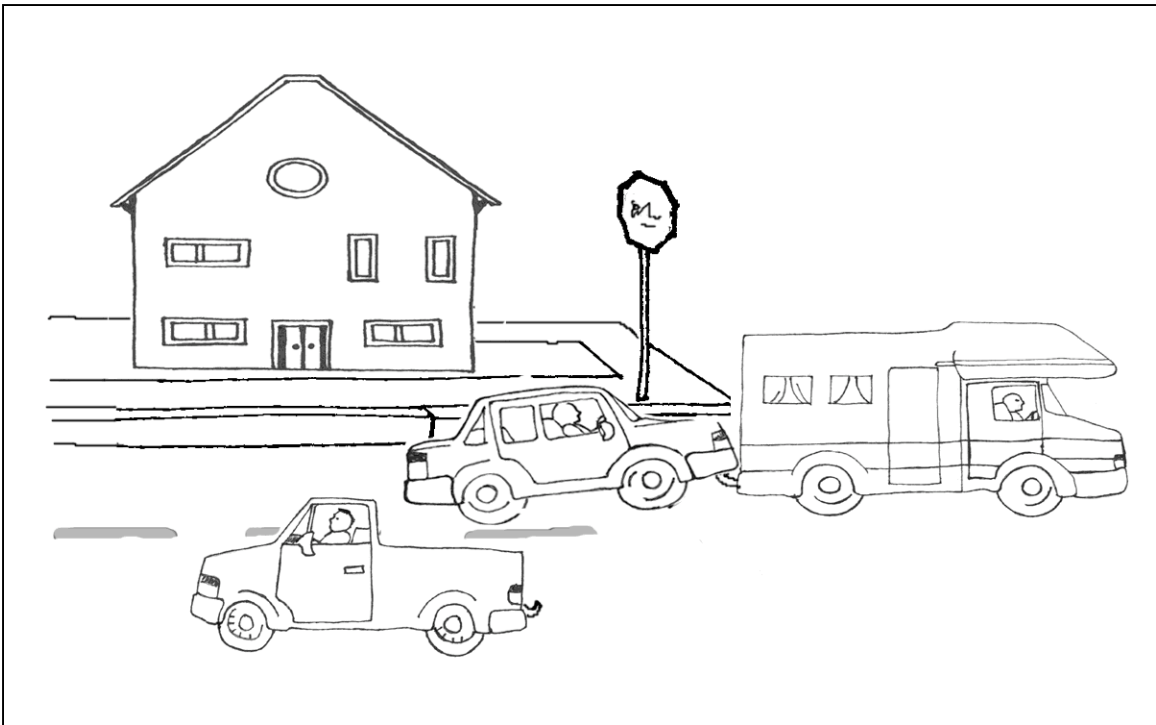
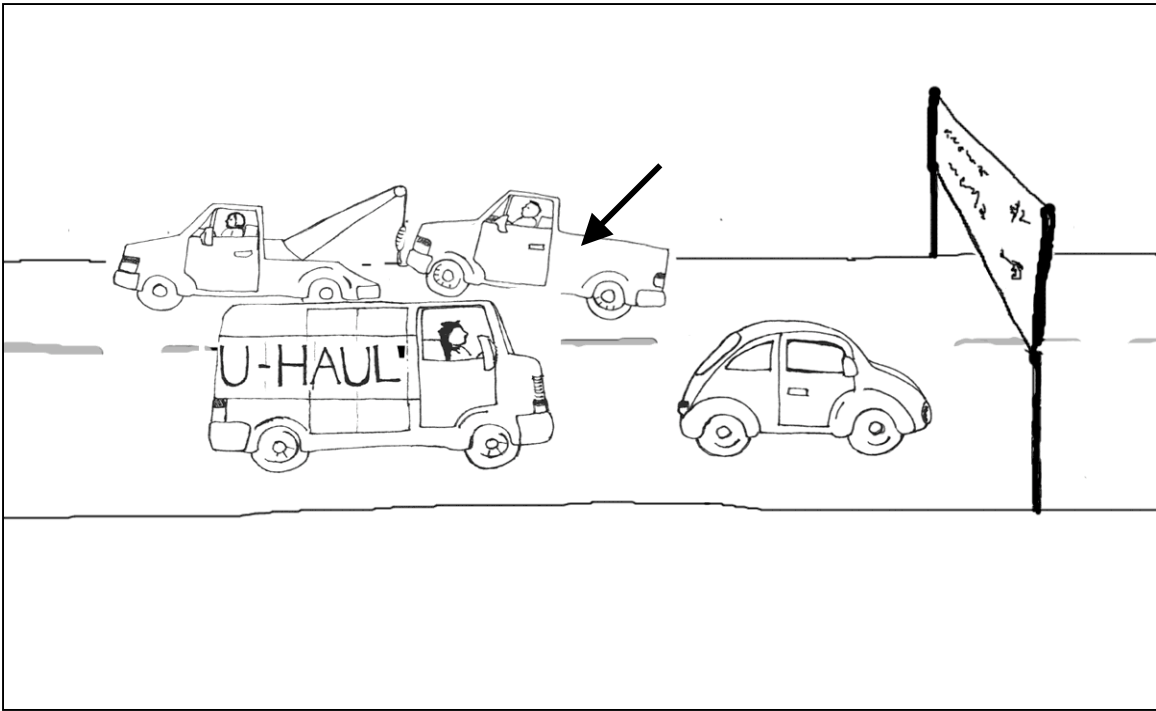

Problem 6-1a

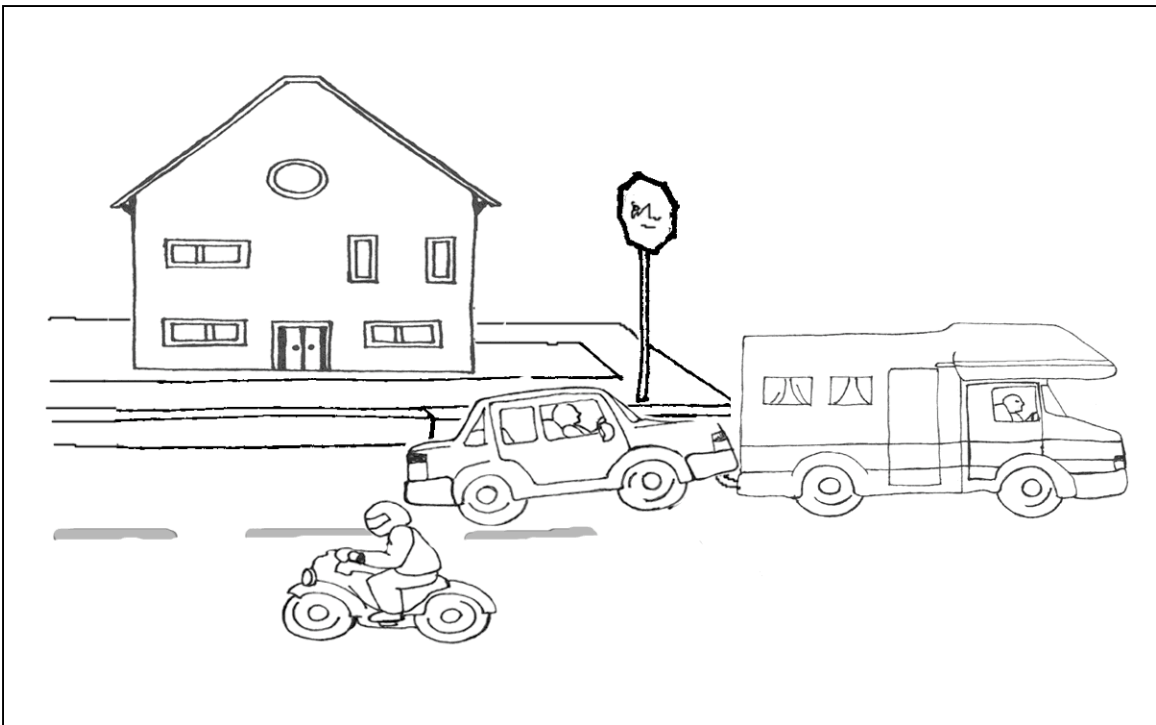
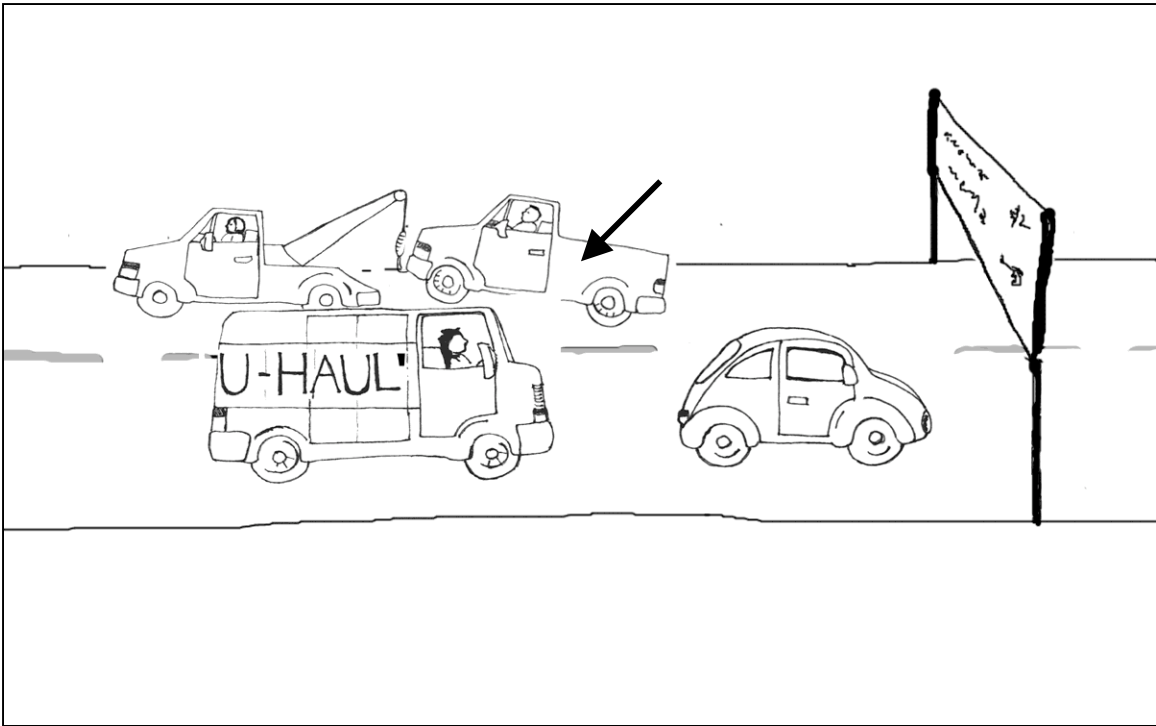

Problem 6-1b

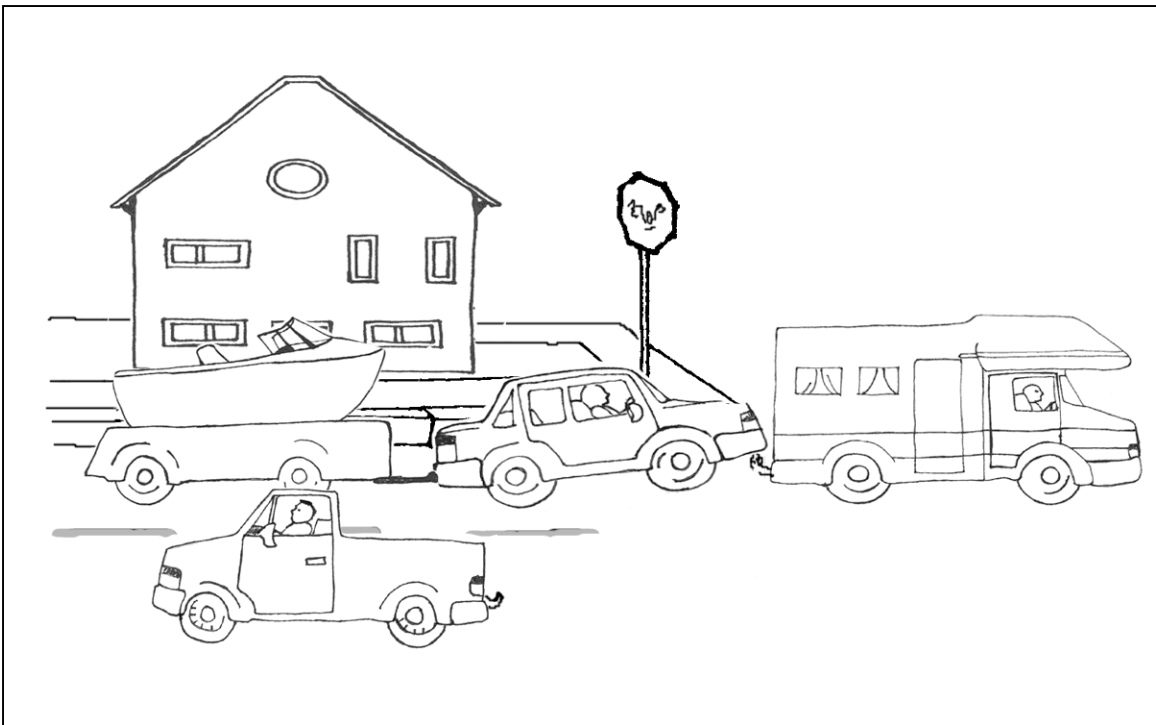
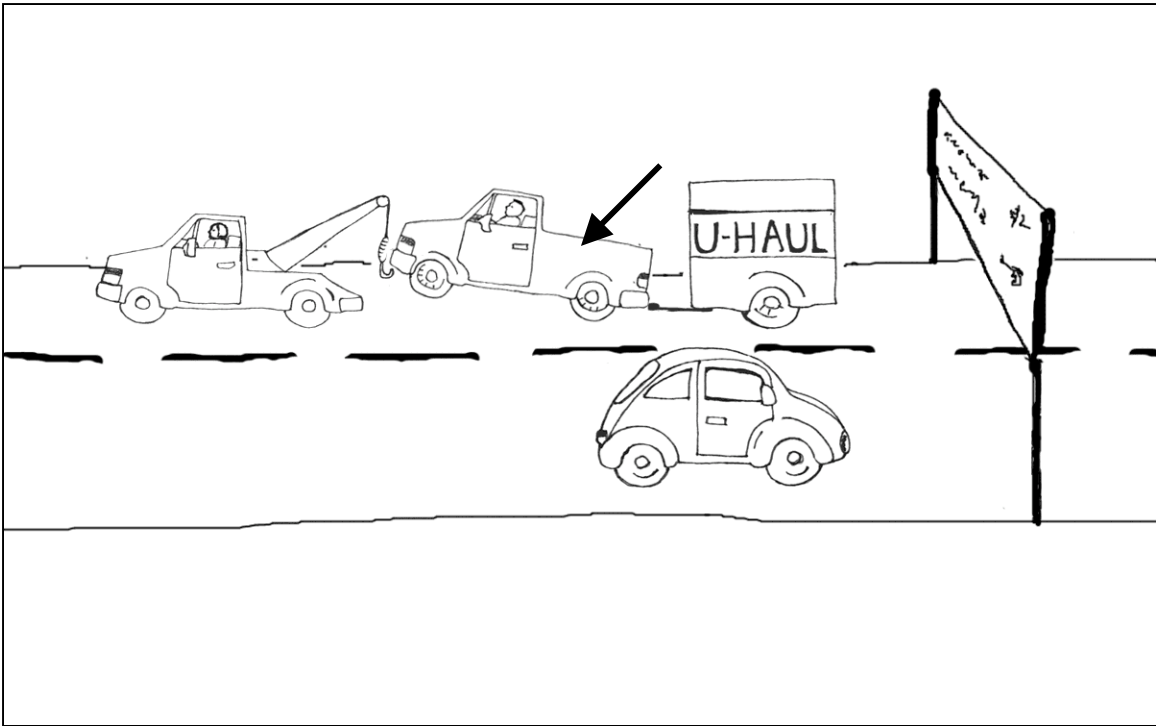

Problem 6-2a

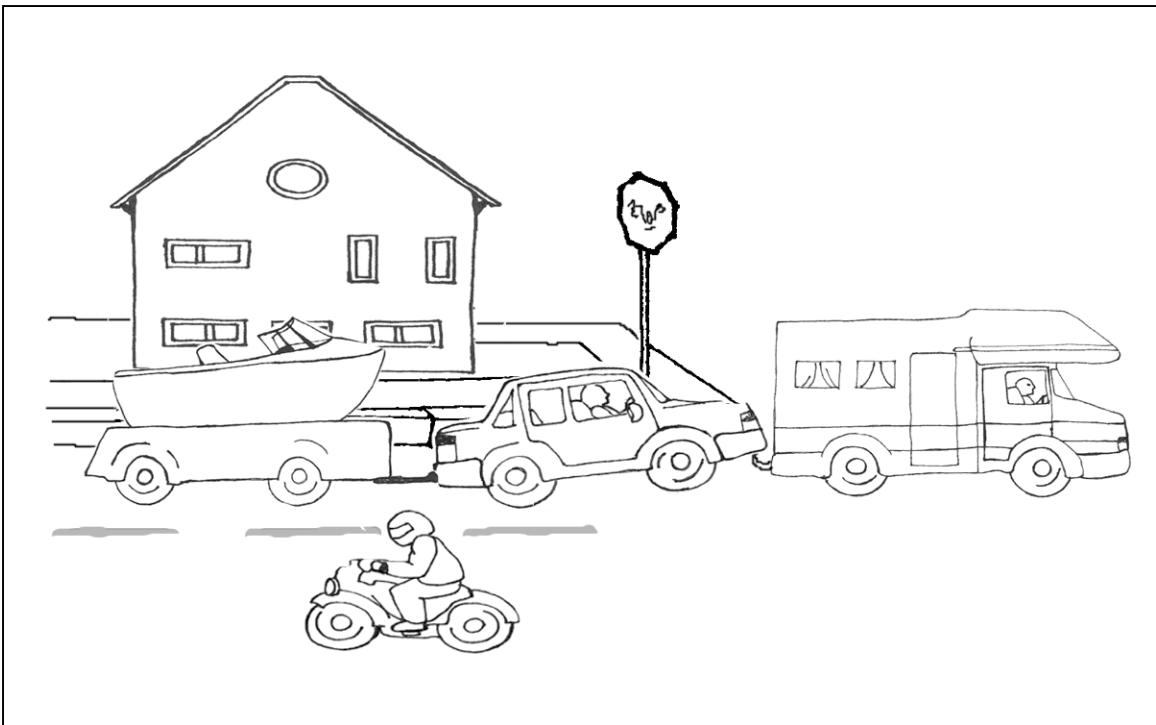
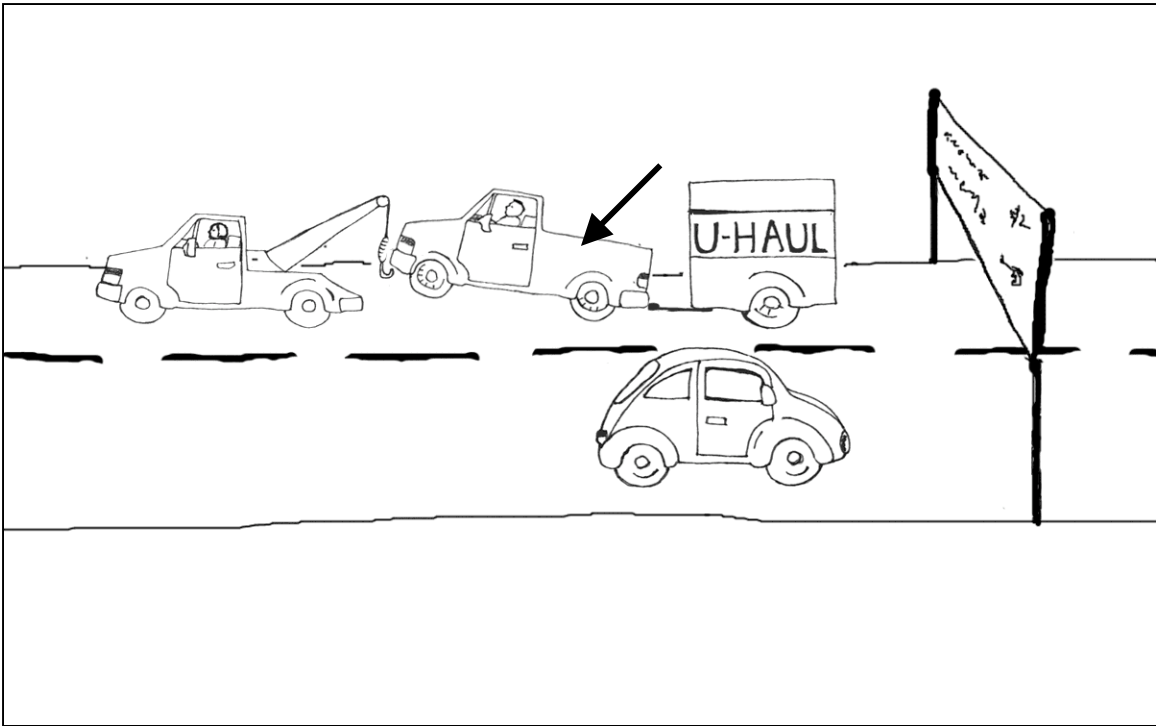

Problem 6-2b

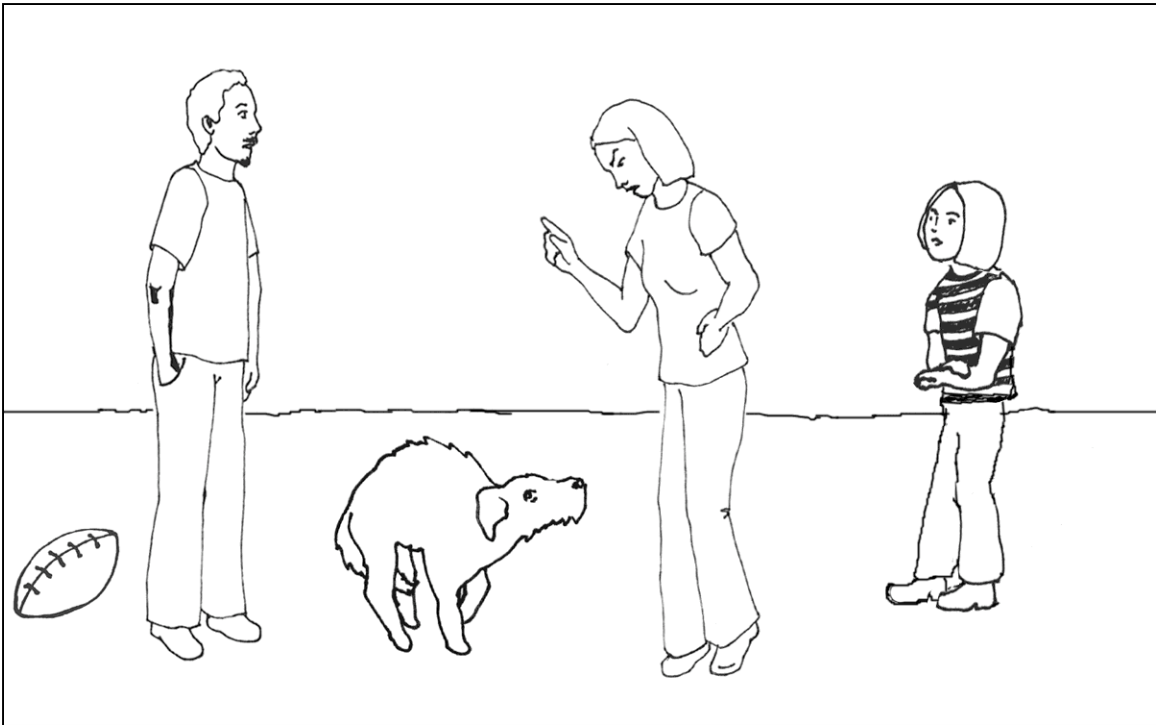
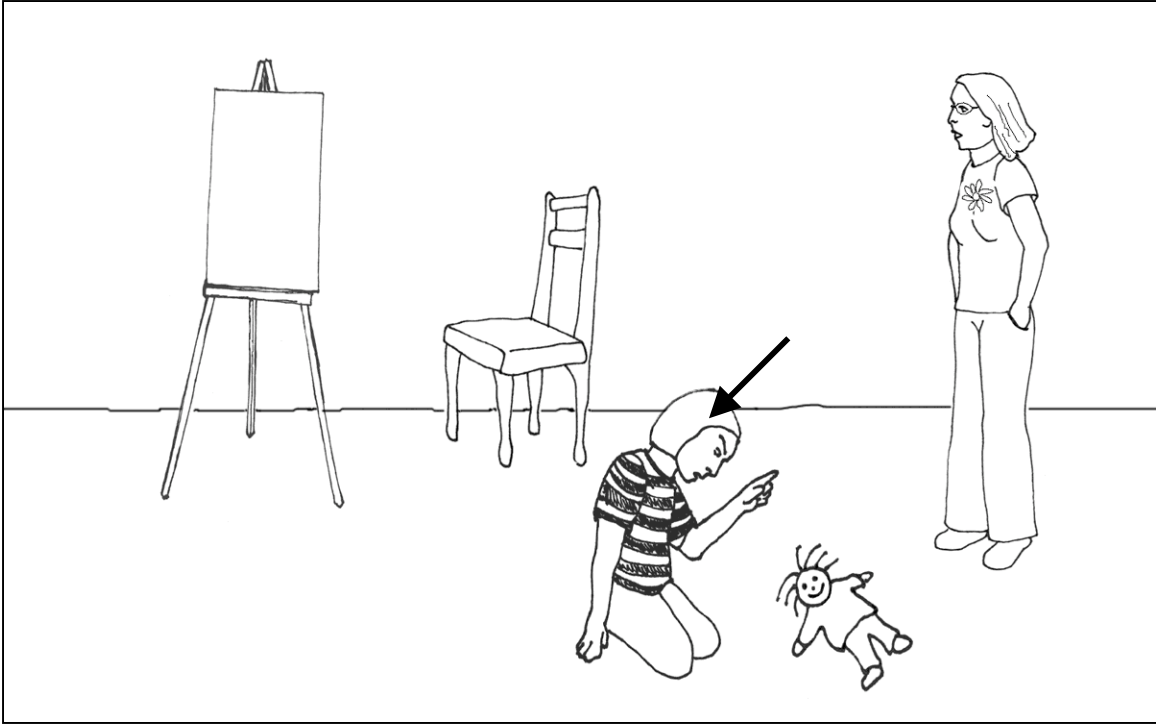

Problem 7-1a

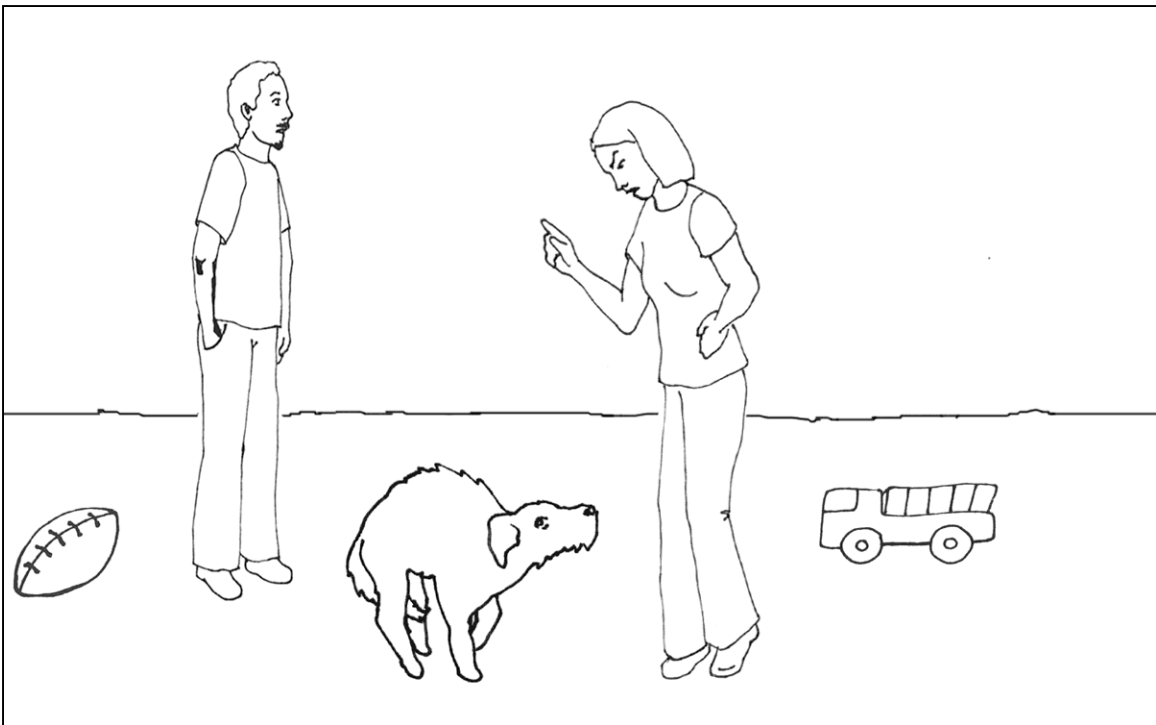
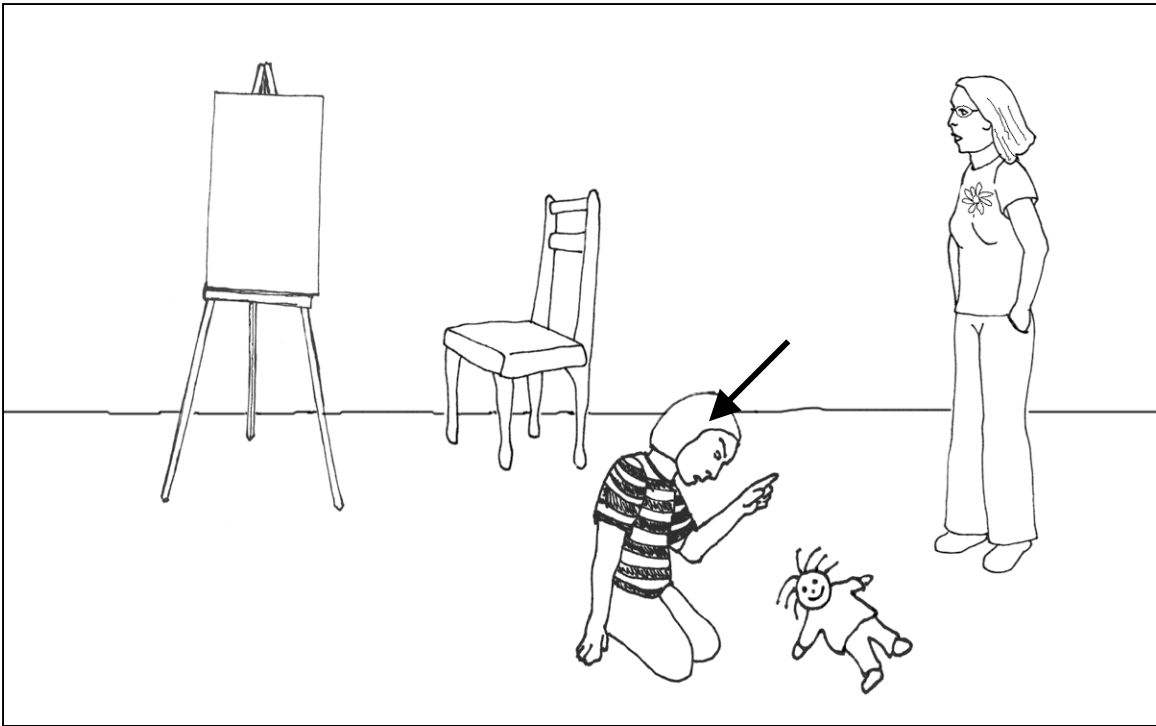

Problem 7-1b

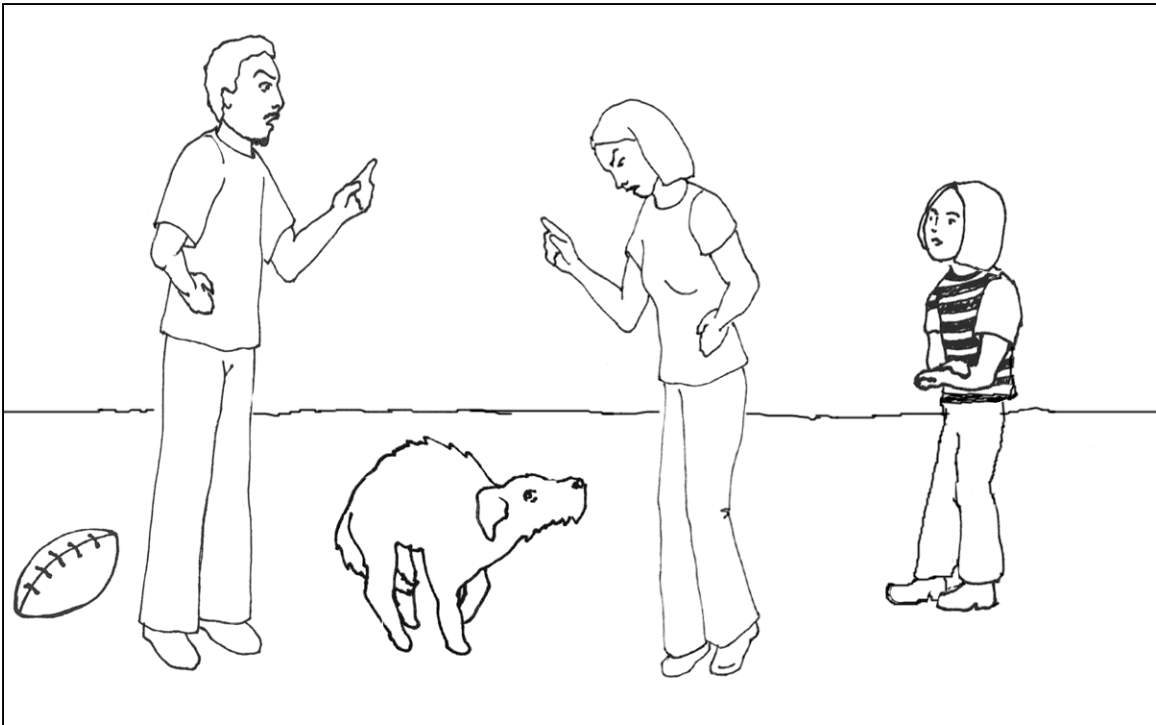
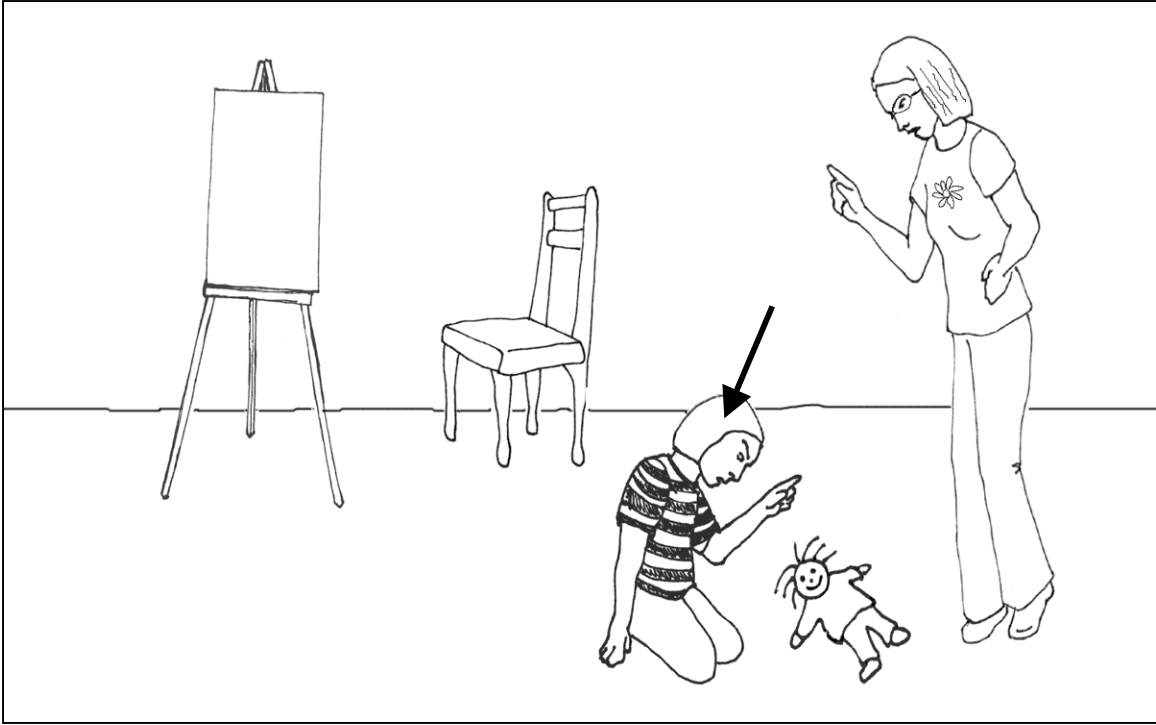

Problem 7-2a

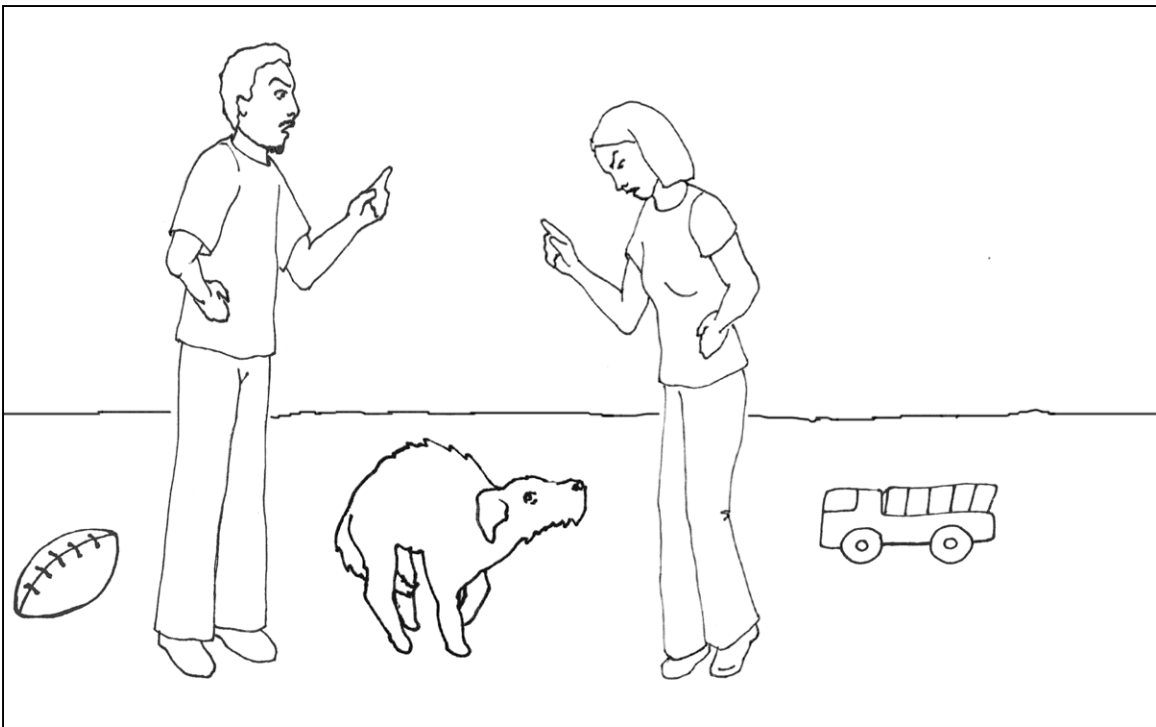
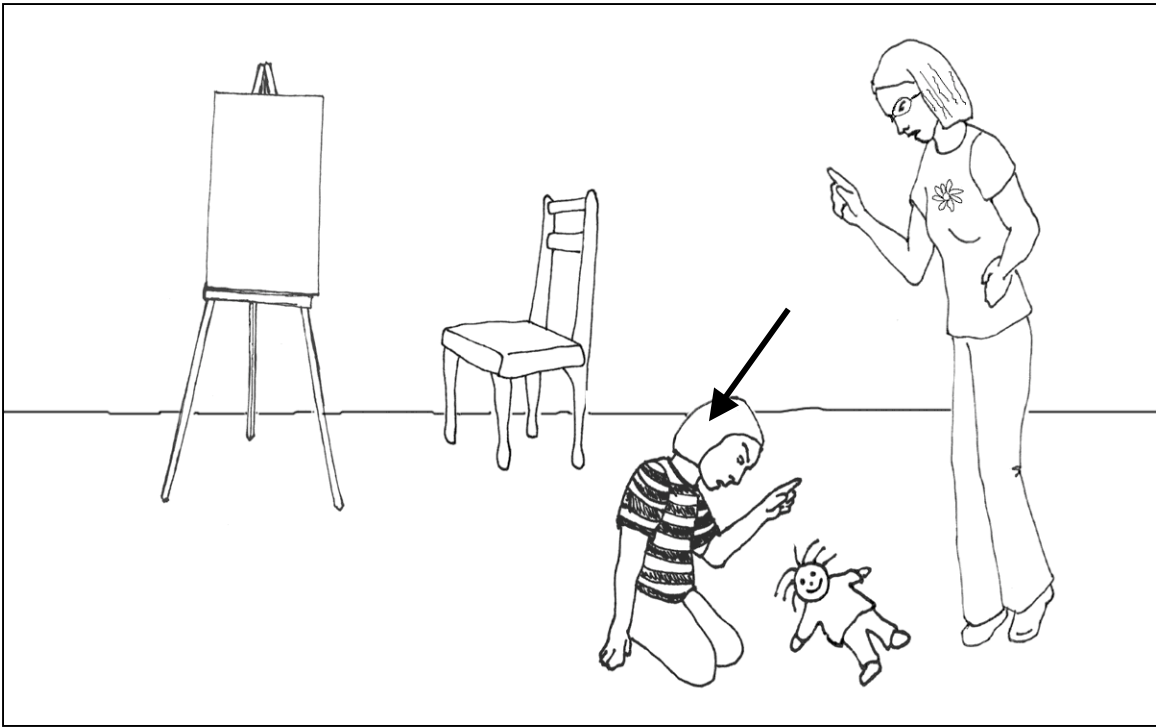

Problem 7-2b

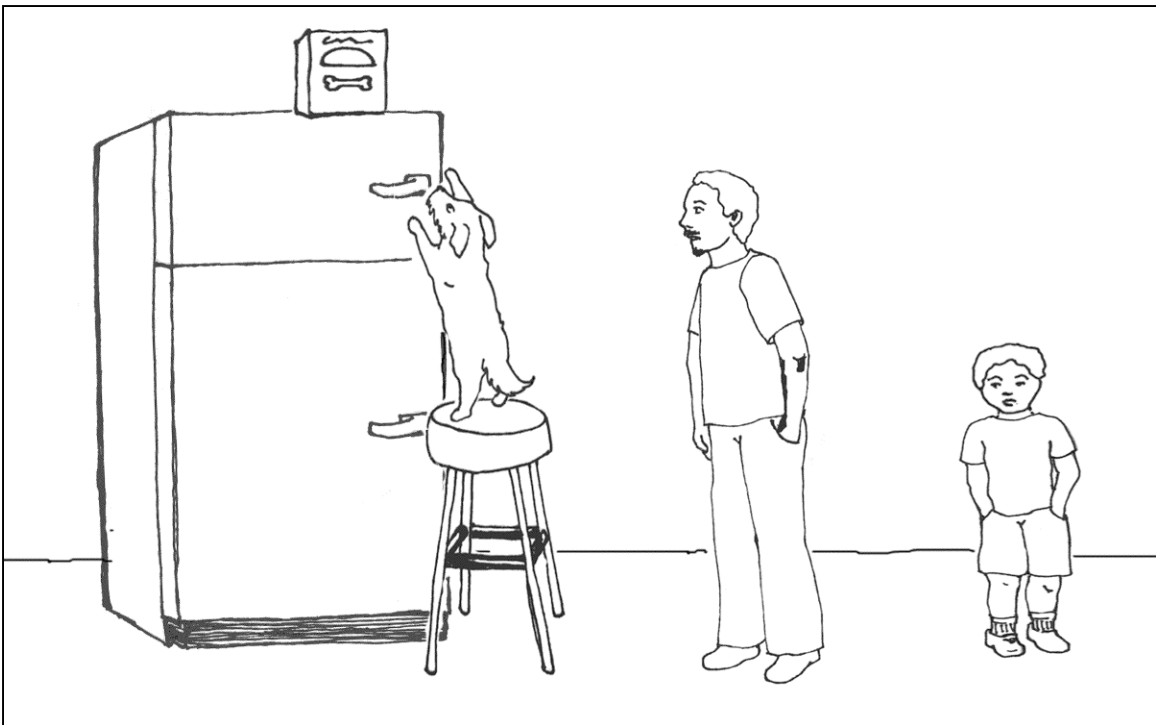
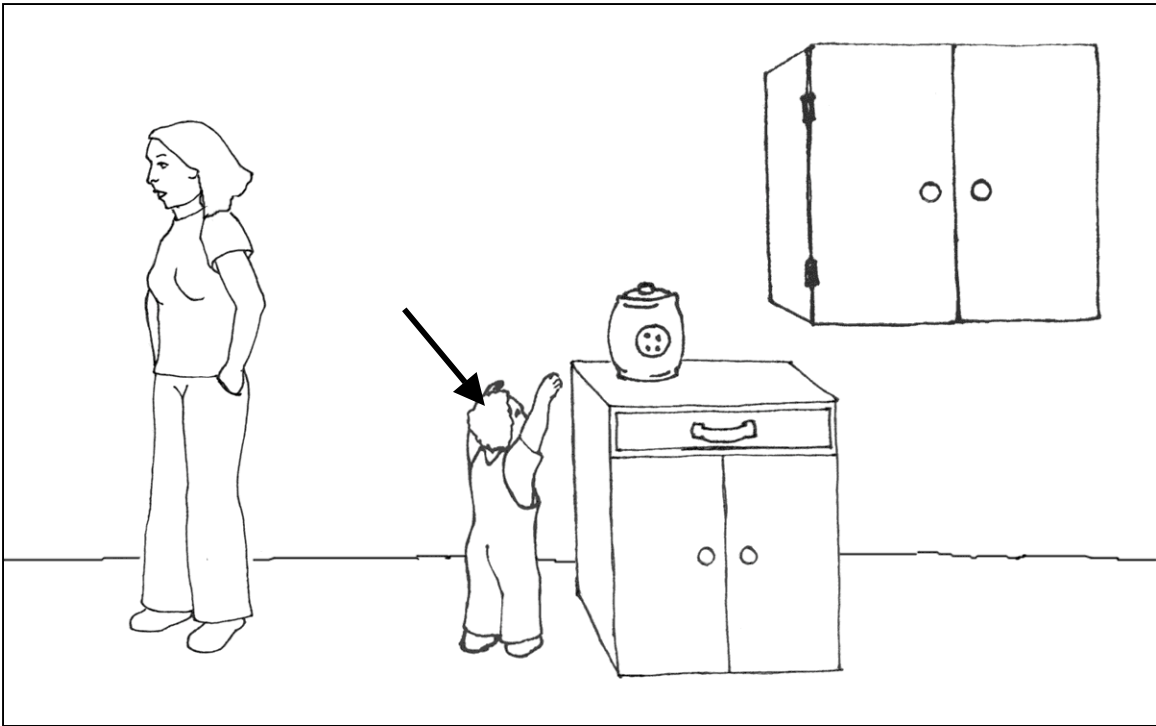

Problem 8-1a

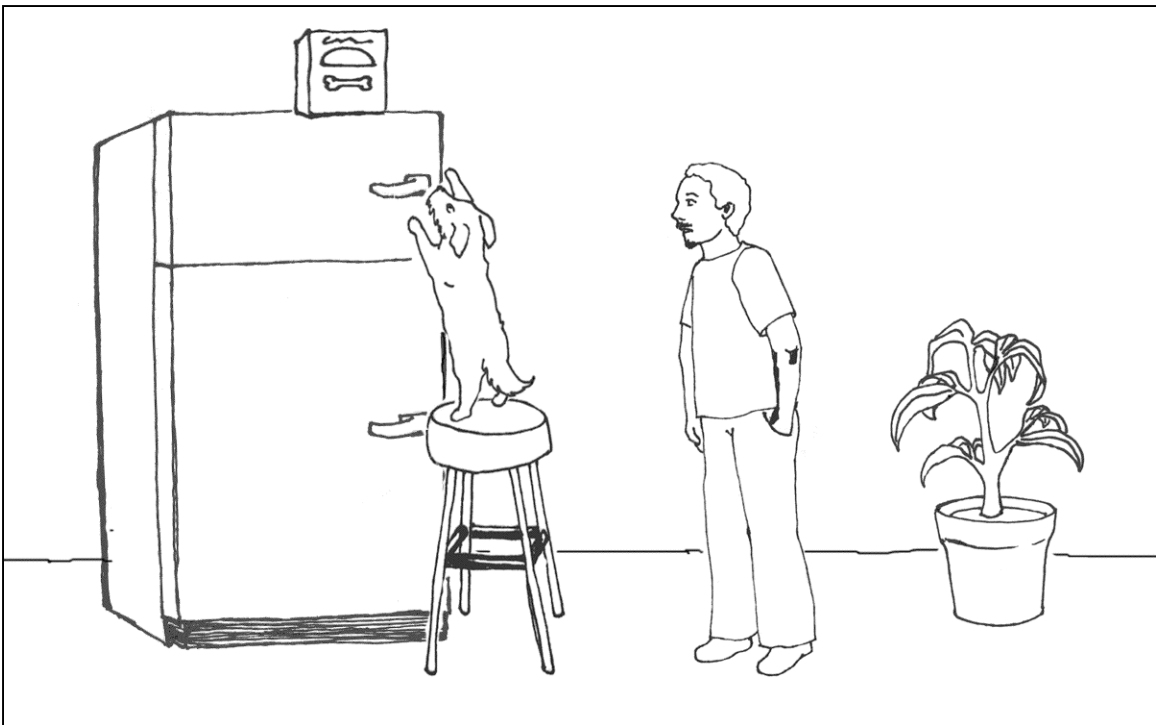
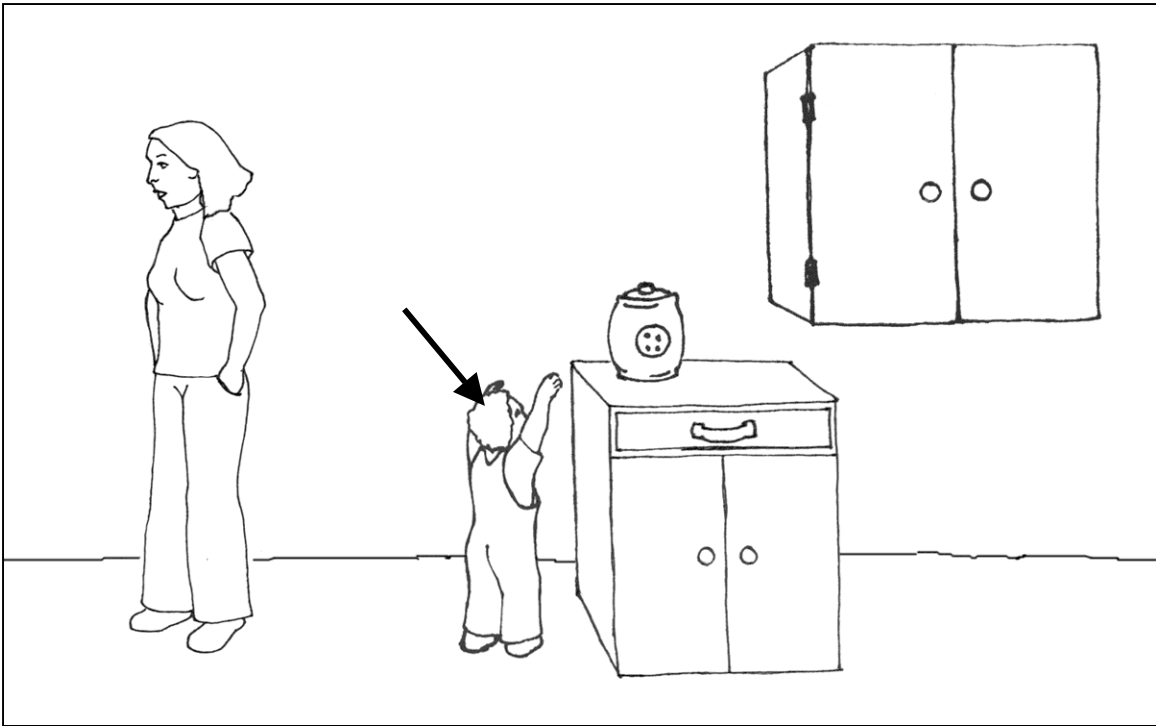

Problem 8-1b

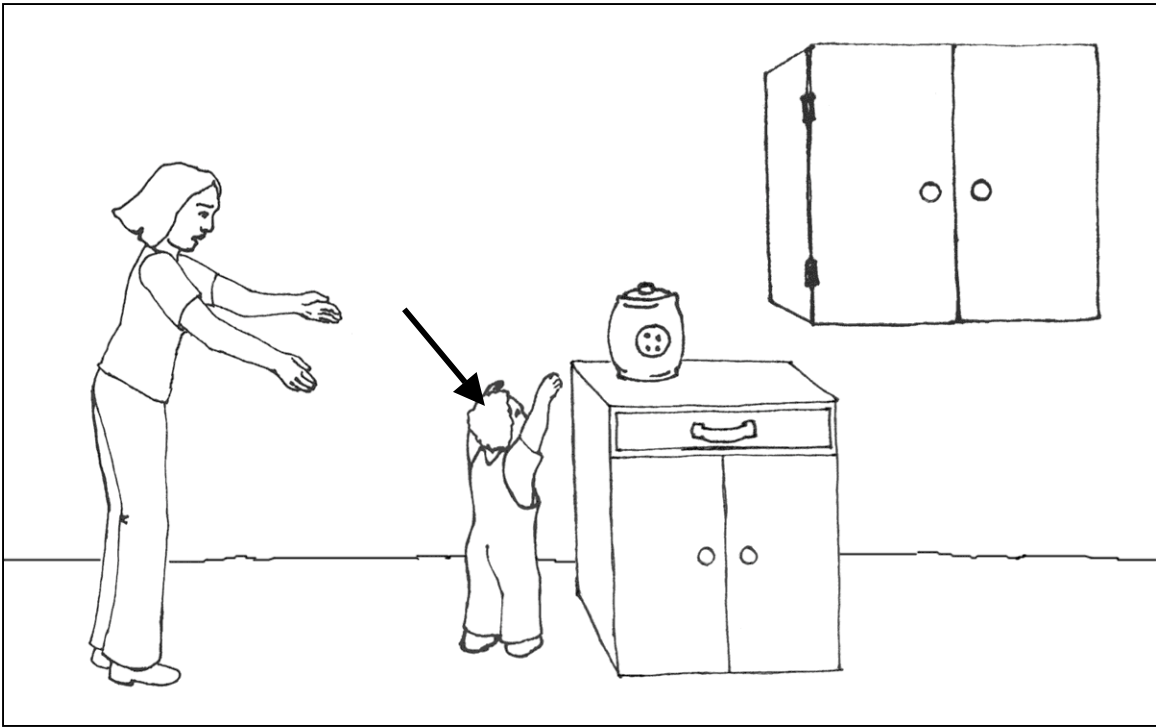

Problem 8-2a

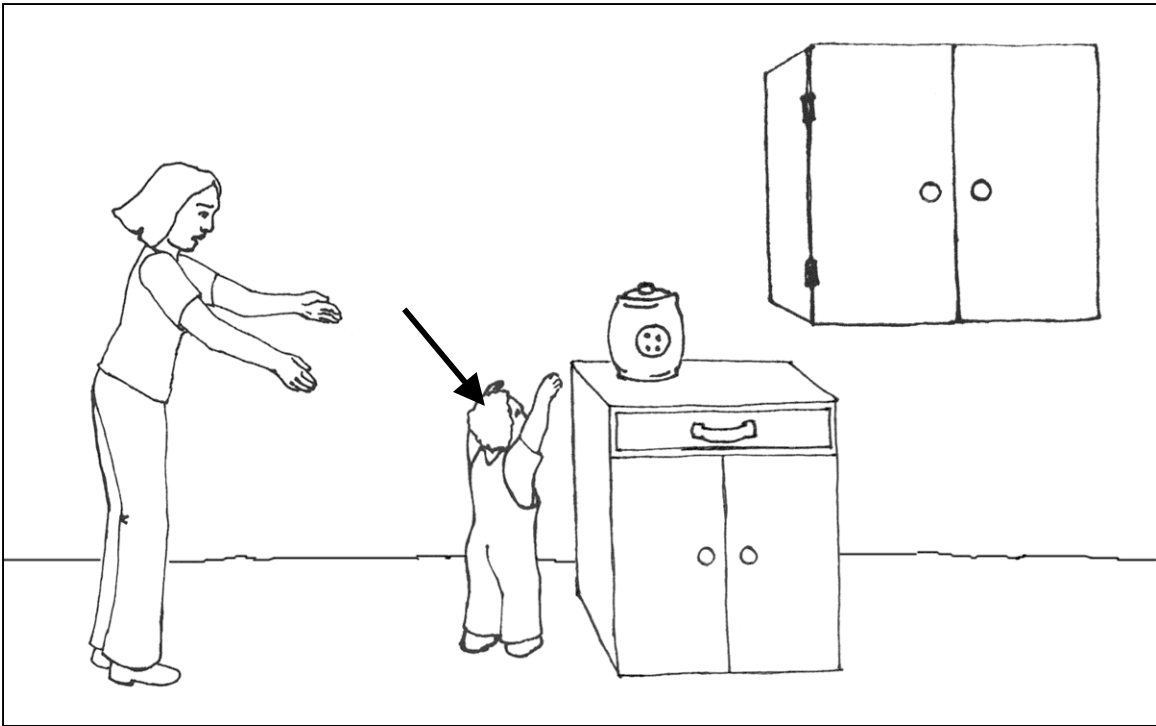

Problem 8-2b

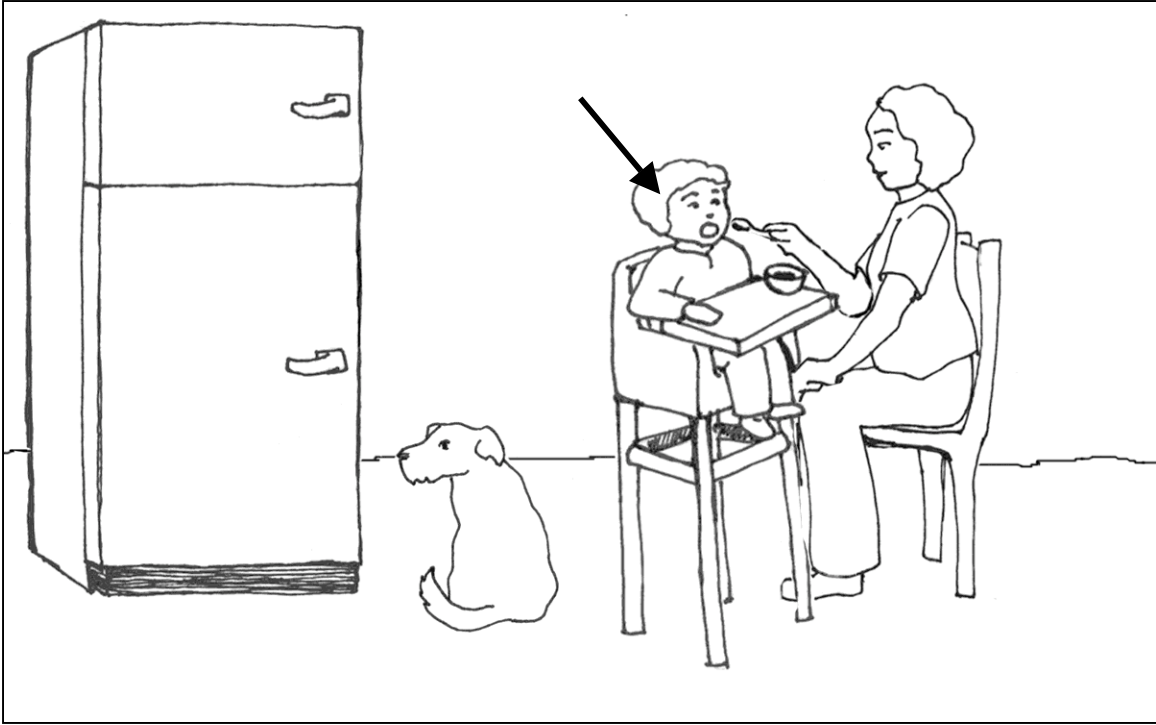

Problem 9-1a

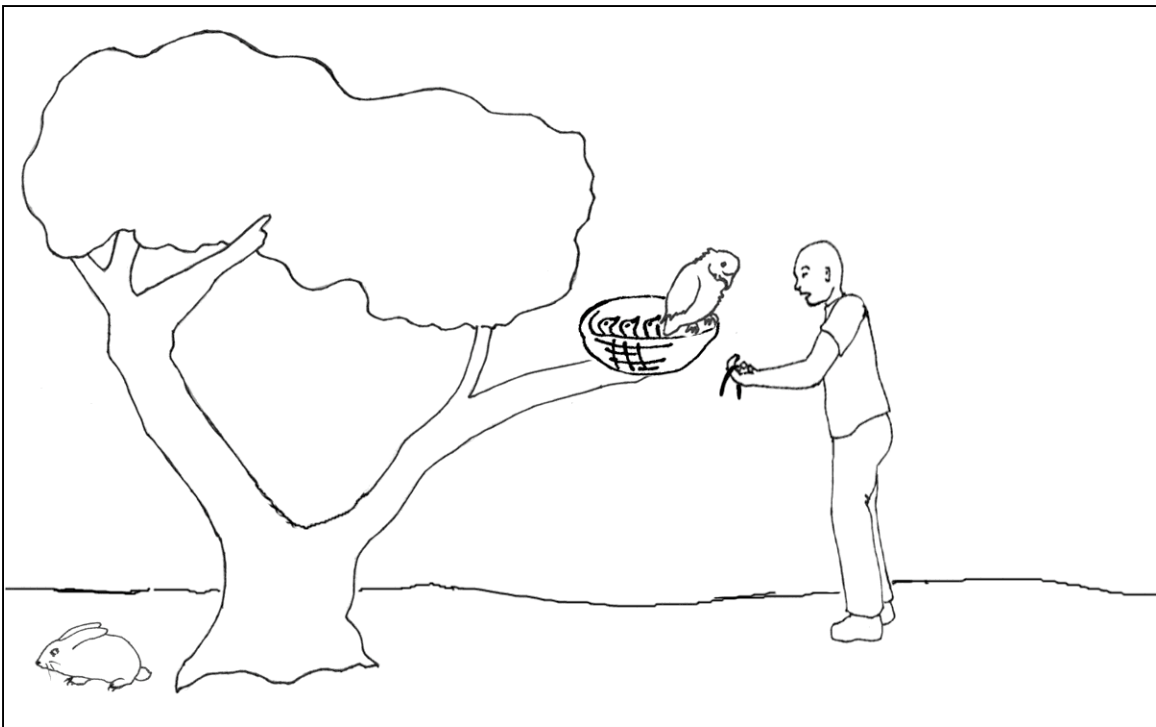
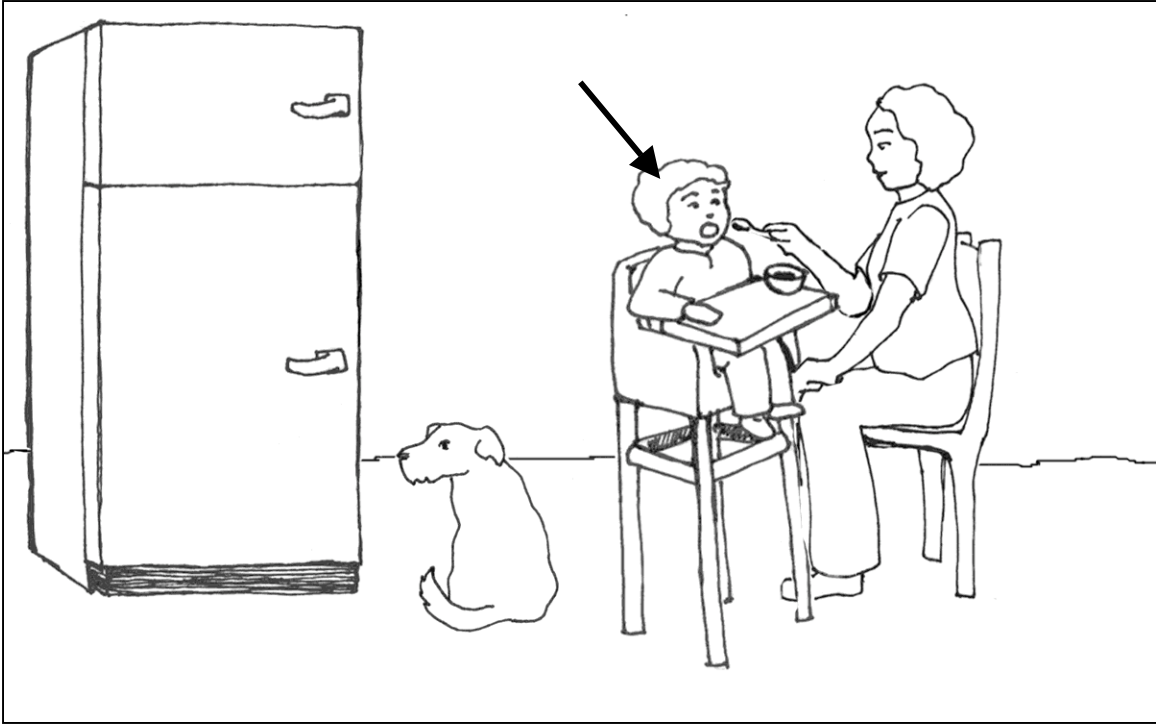

Problem 9-1b

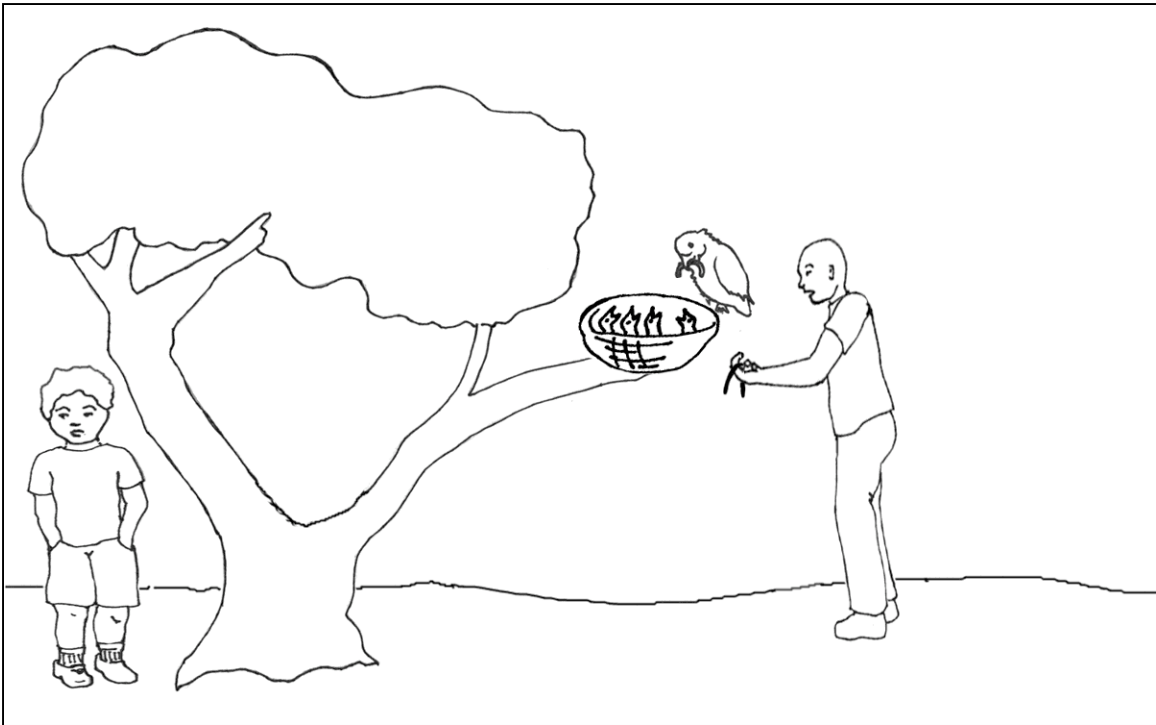
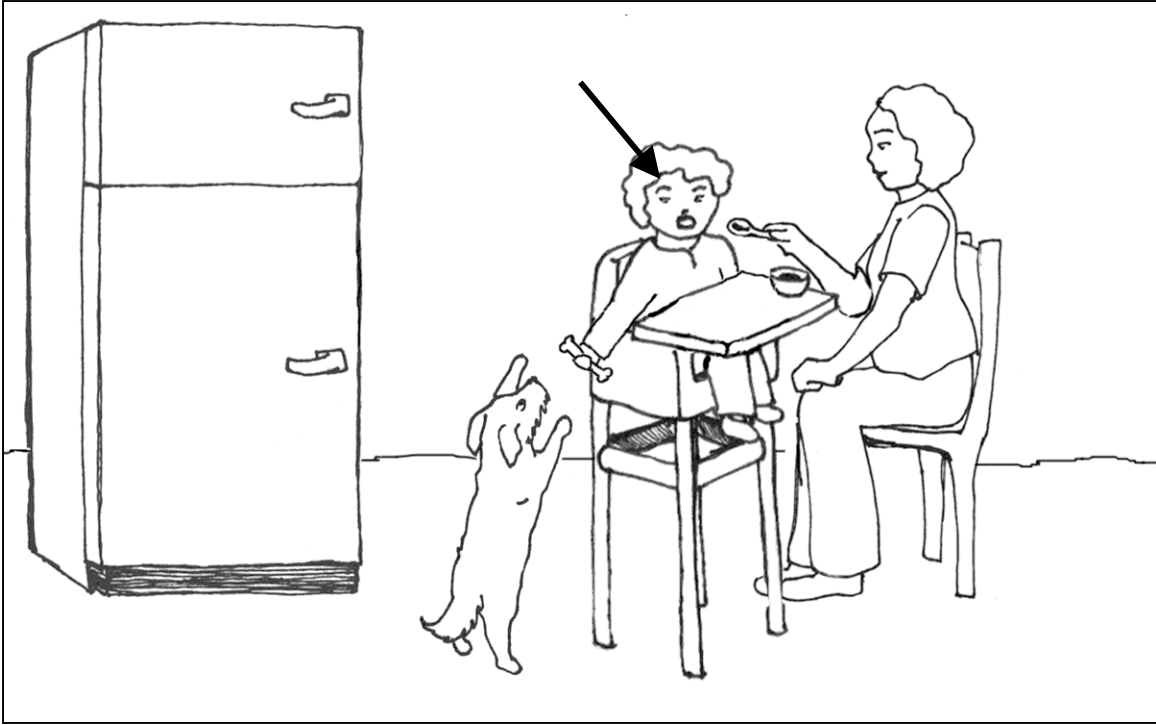

Problem 9-2a

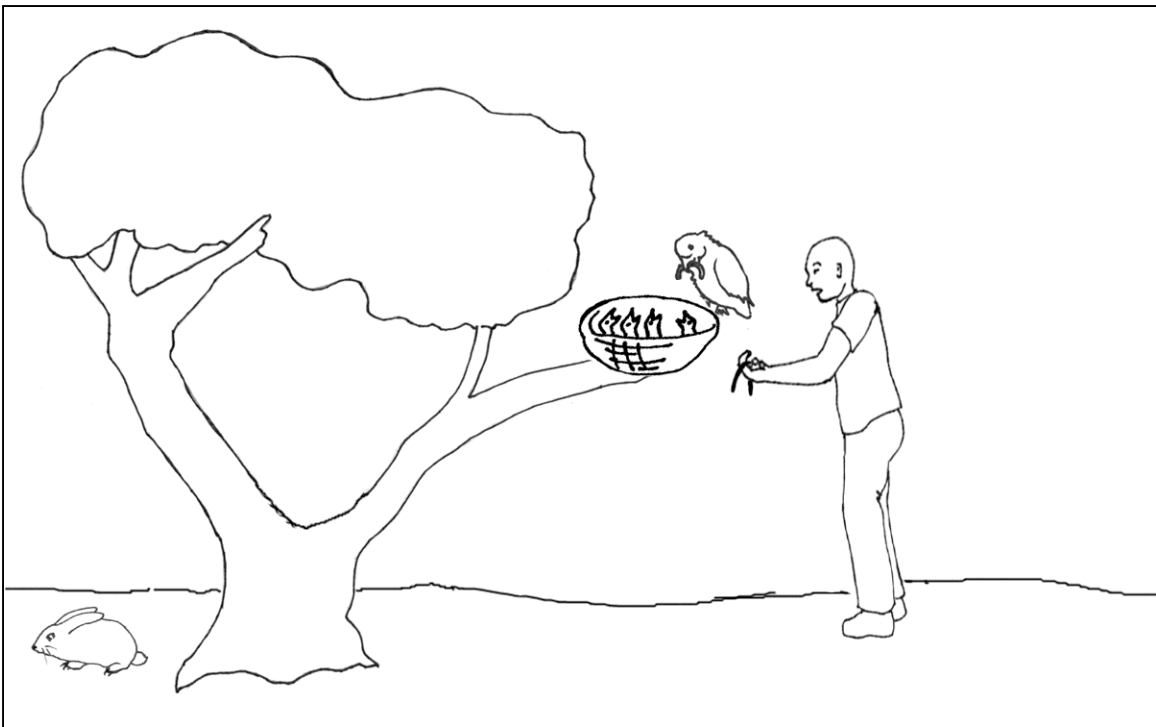
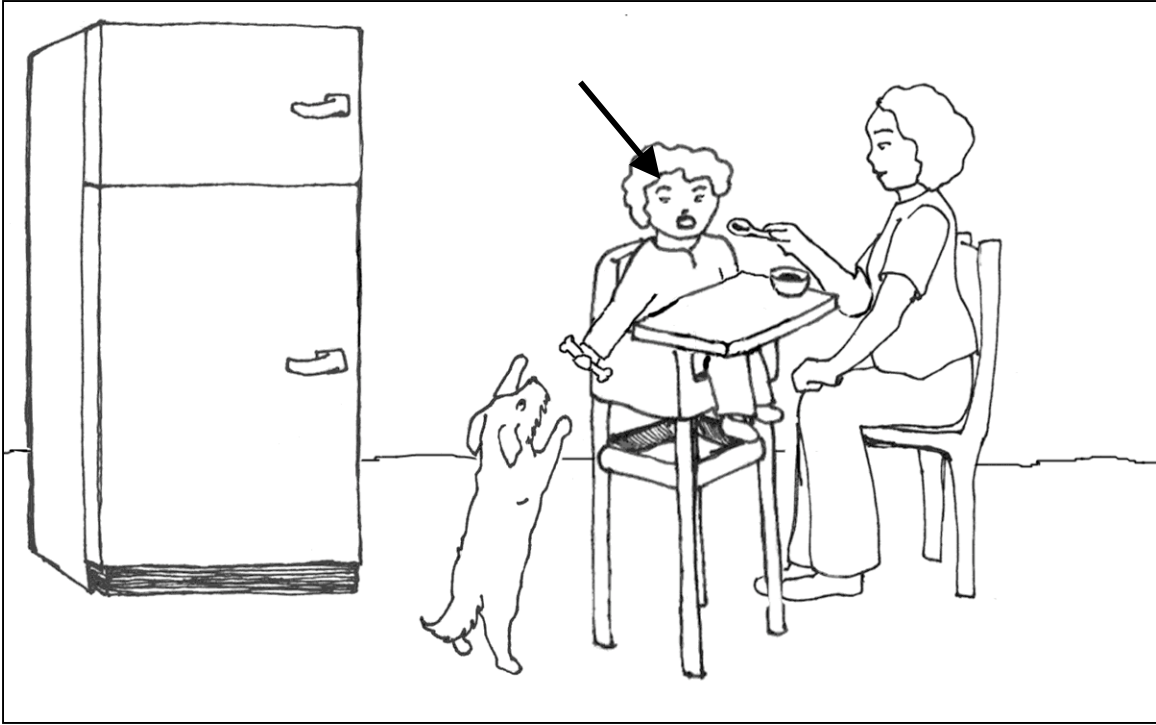

Problem 9-2b

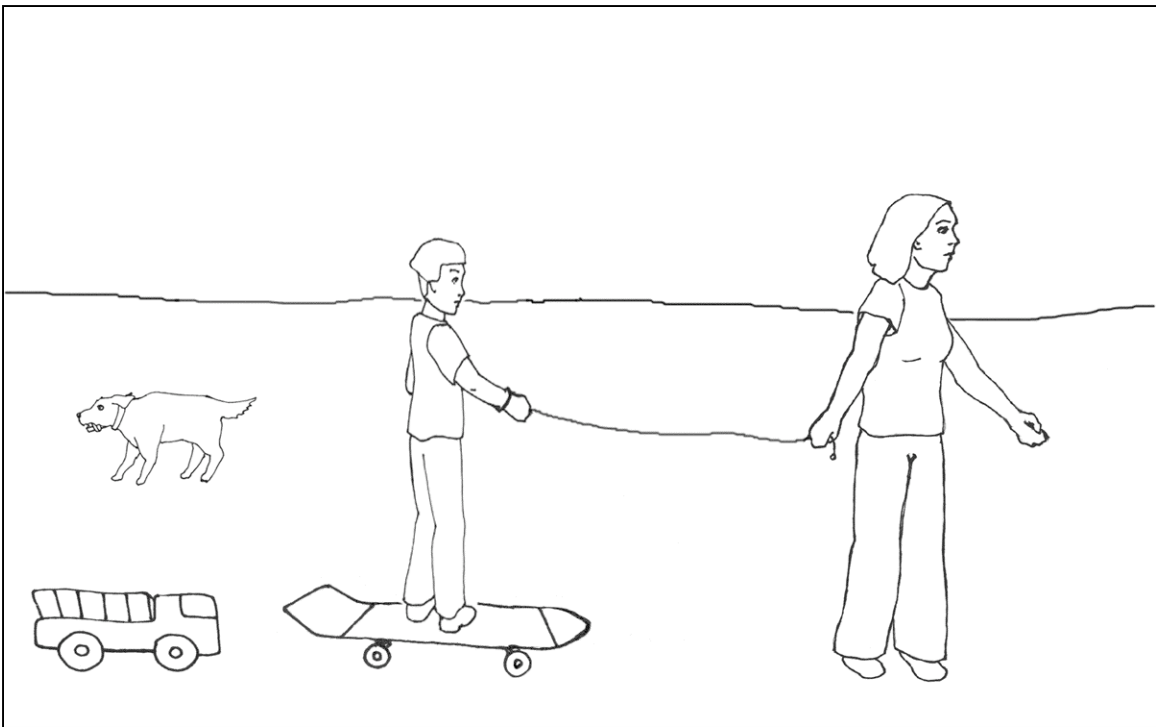
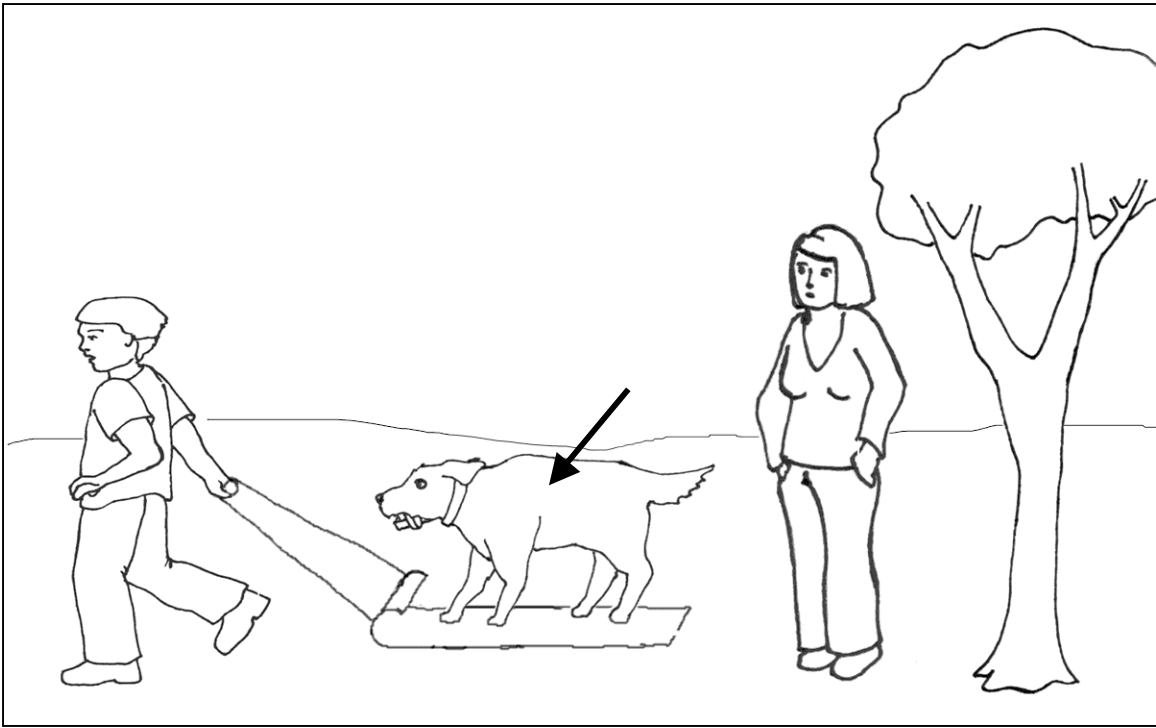

Problem 10-1a

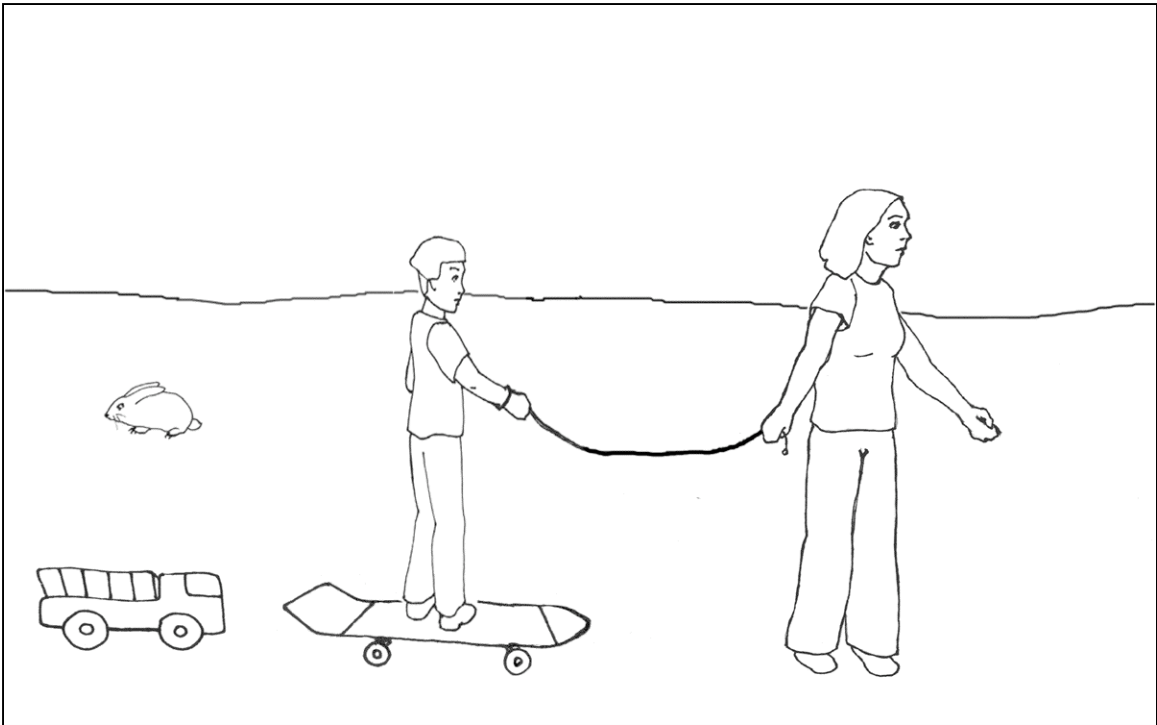
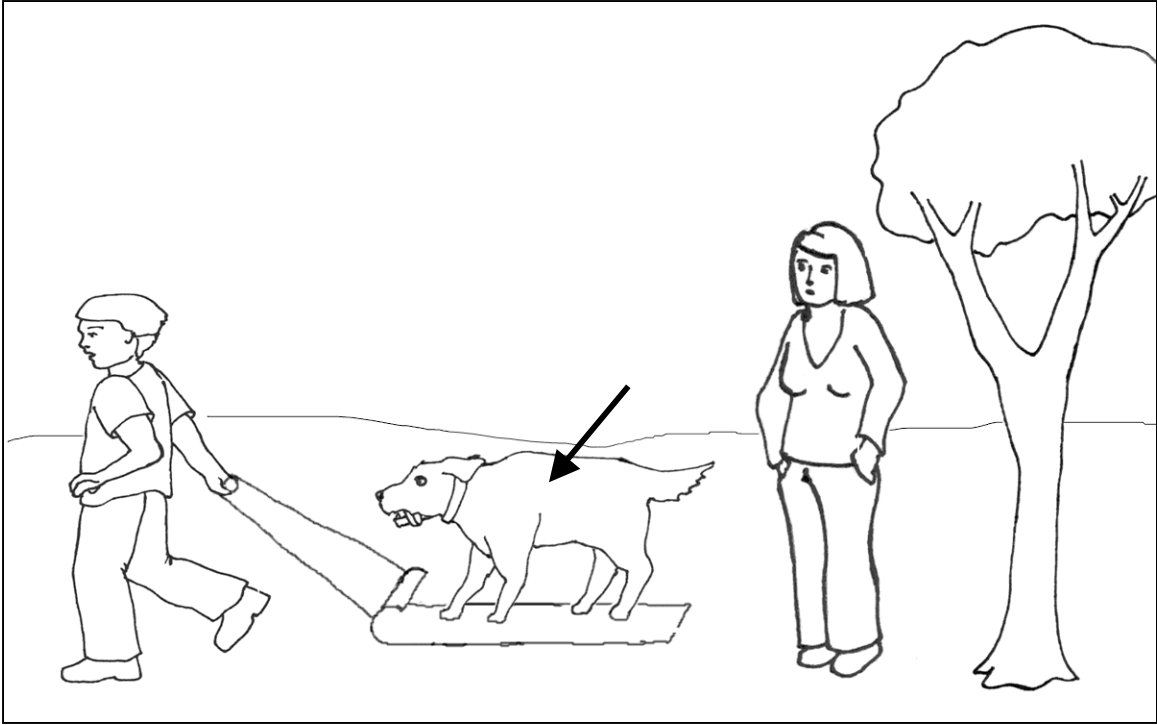

Problem 10-1b

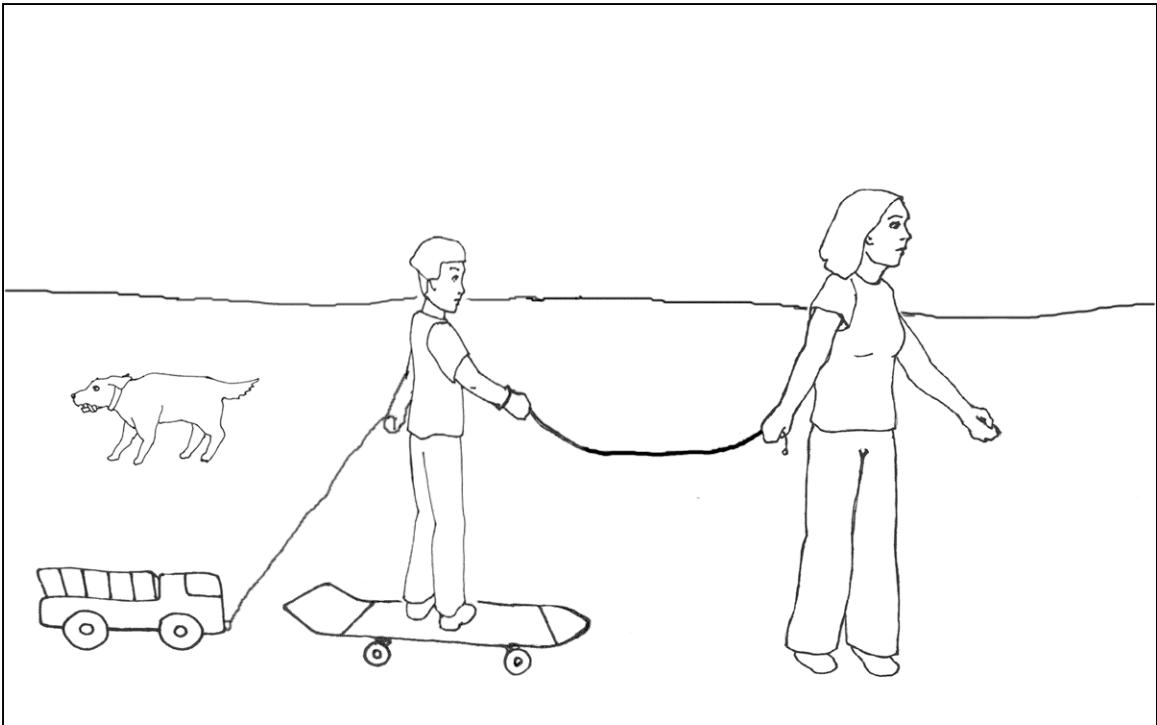
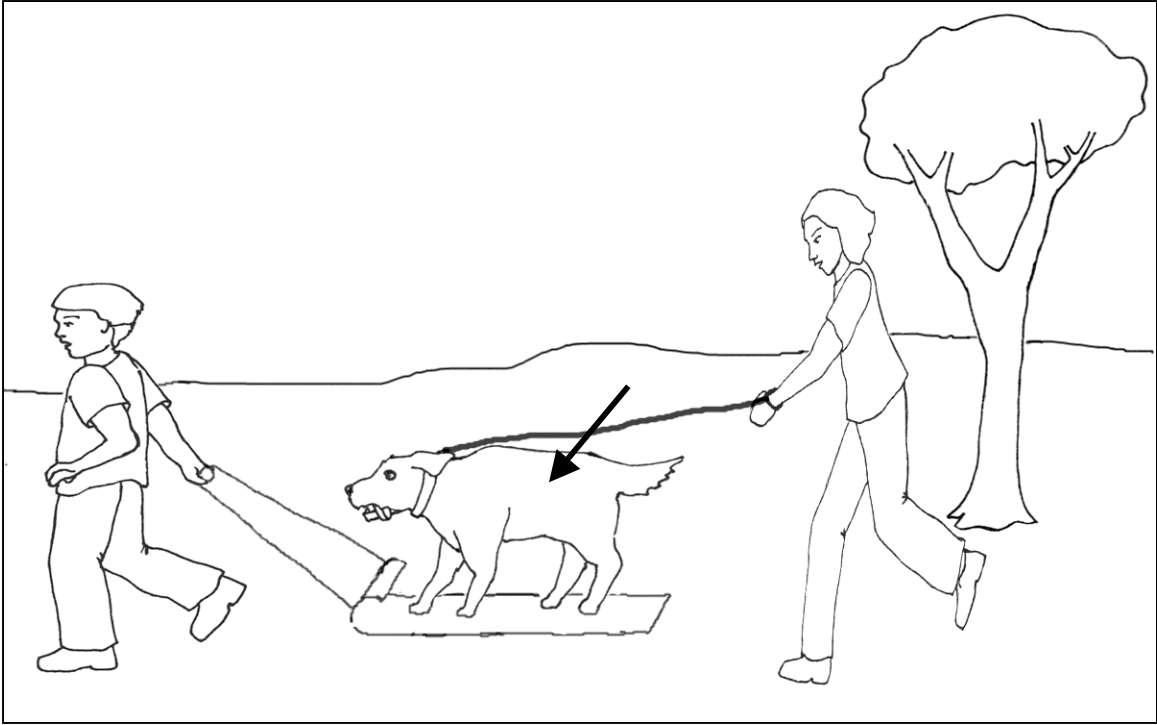

Problem 10-2a

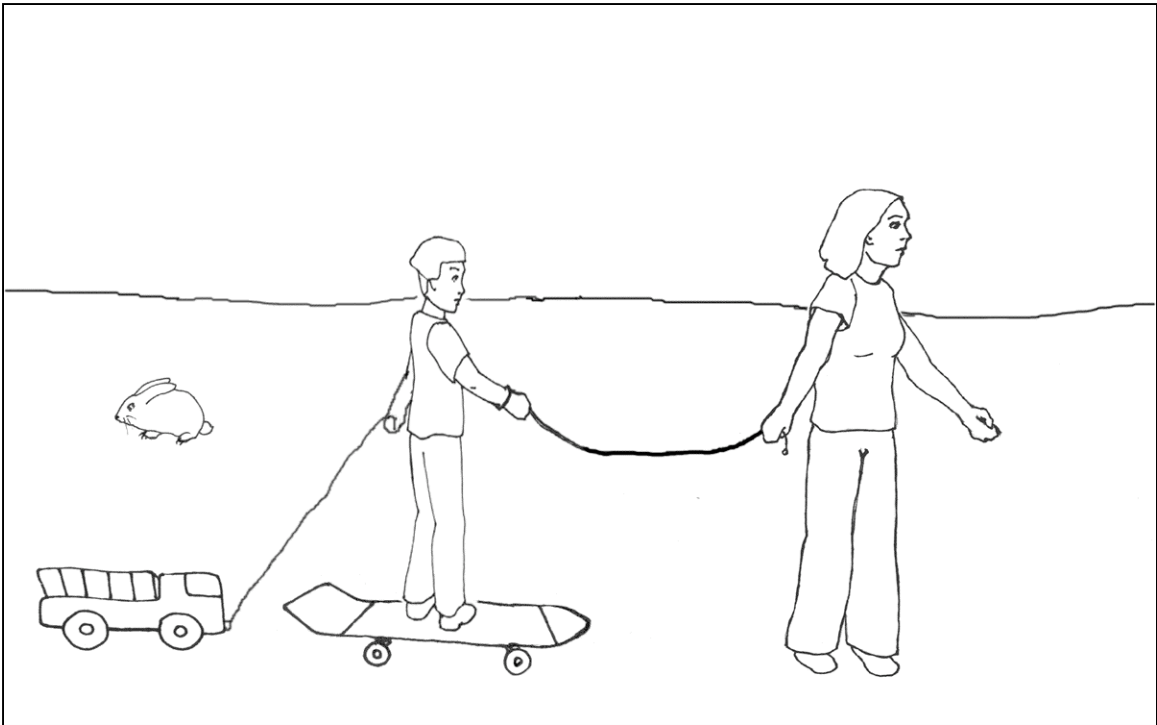
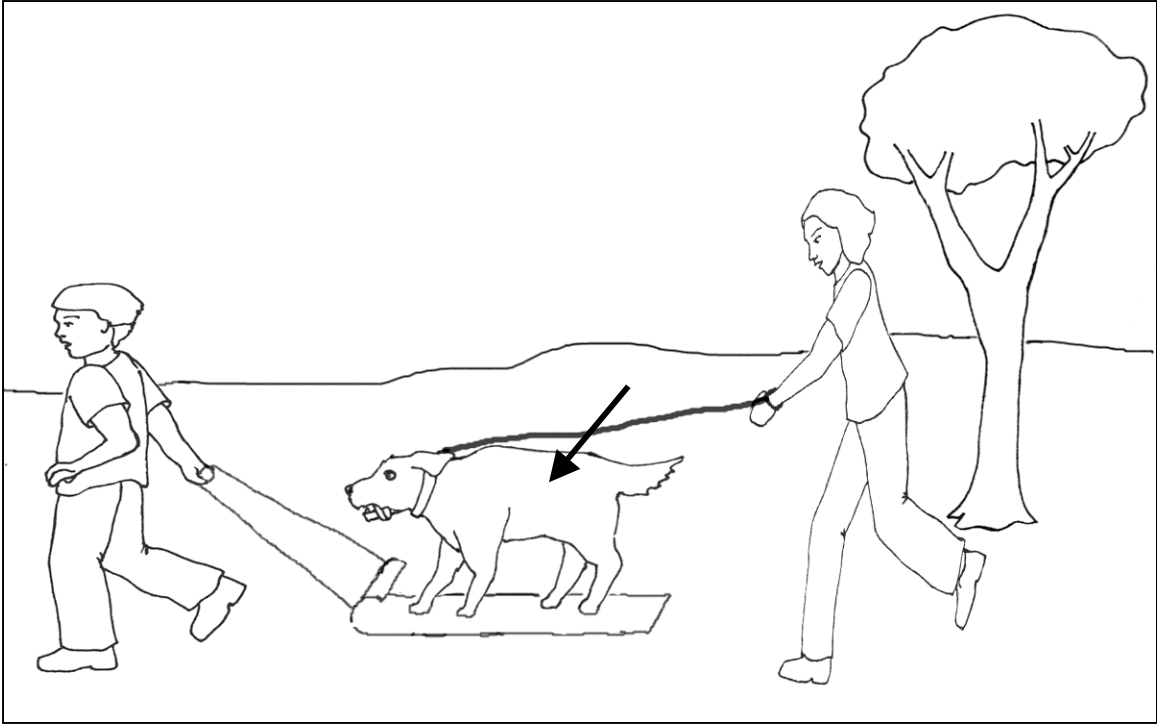

Problem 10-2b

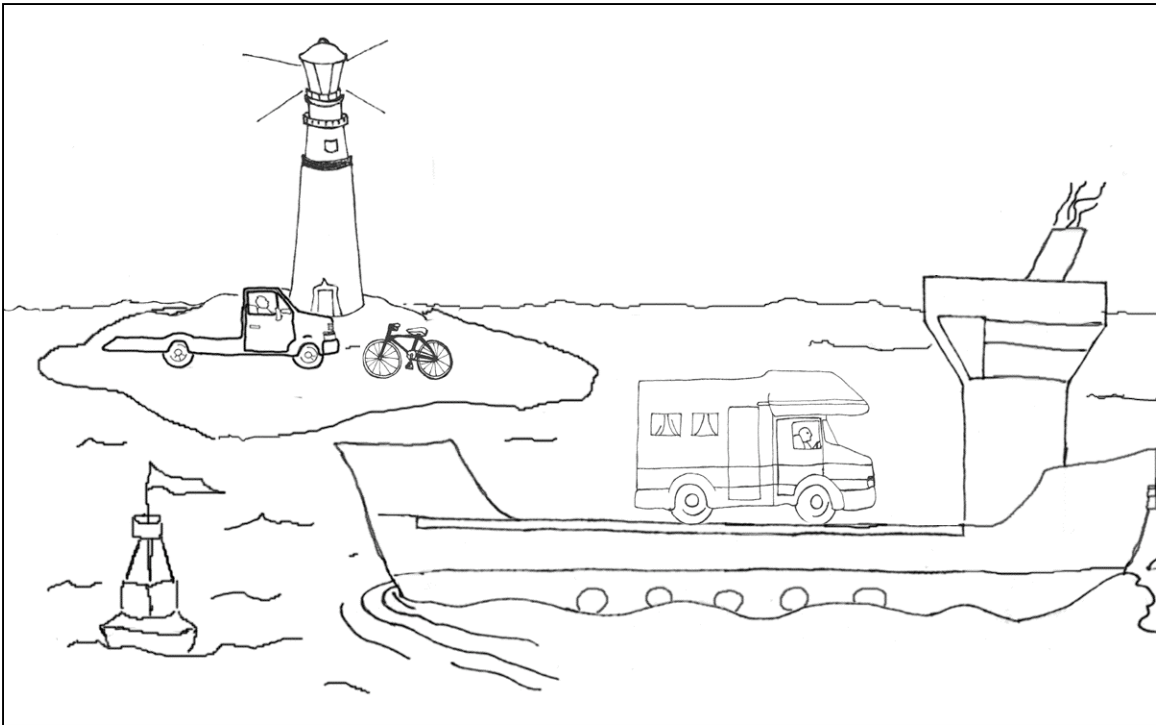
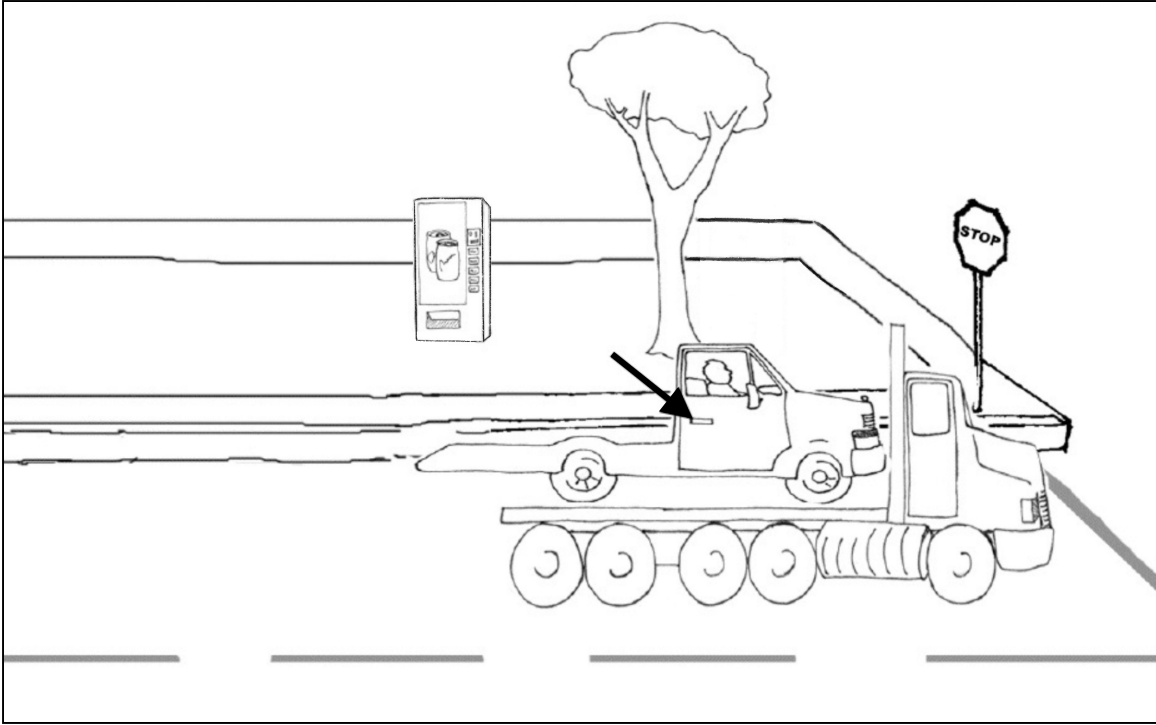

Problem 11-1a

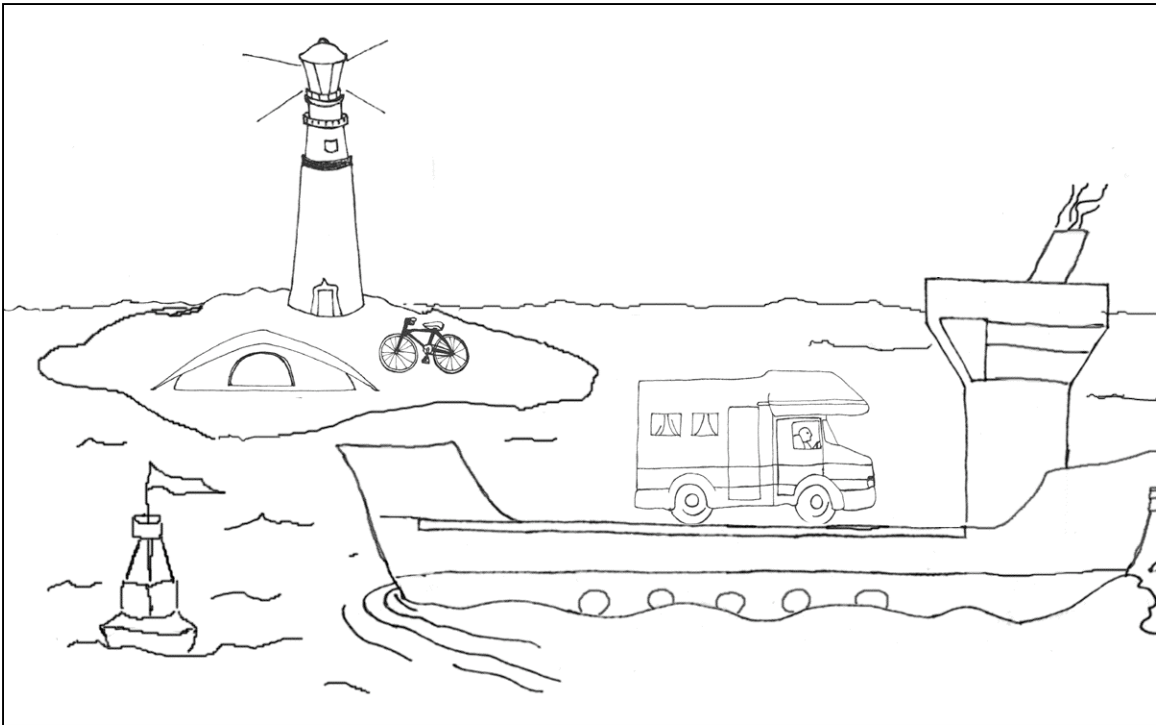
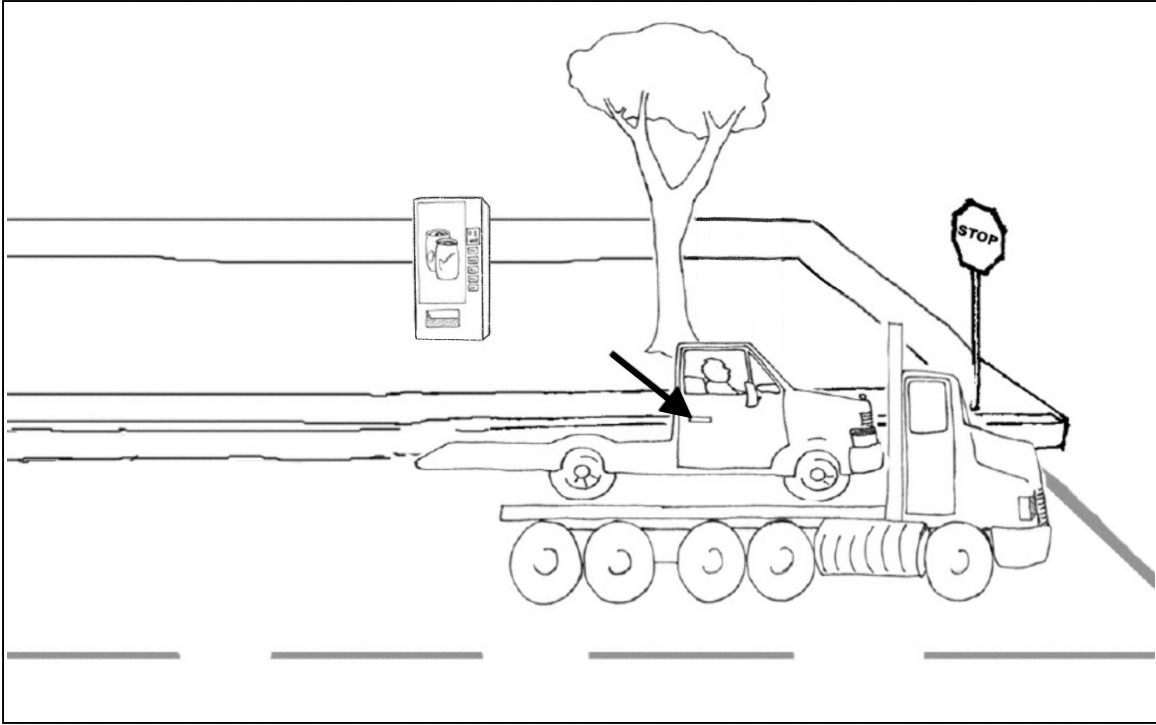

Problem 11-1b

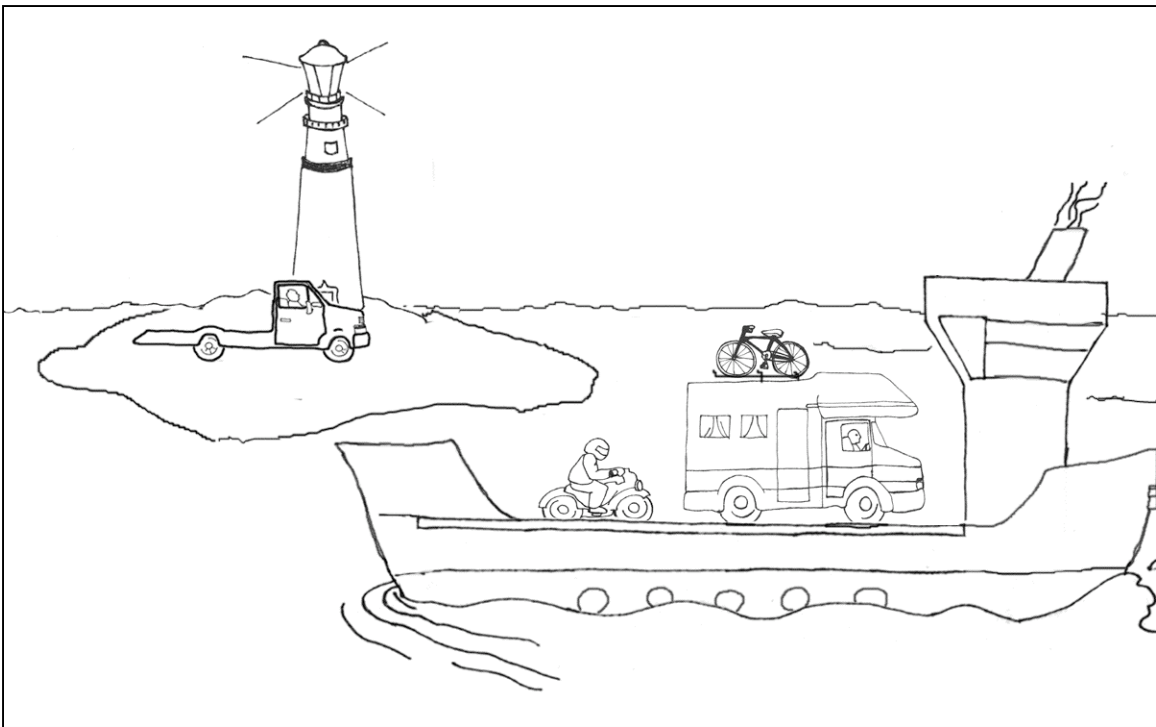
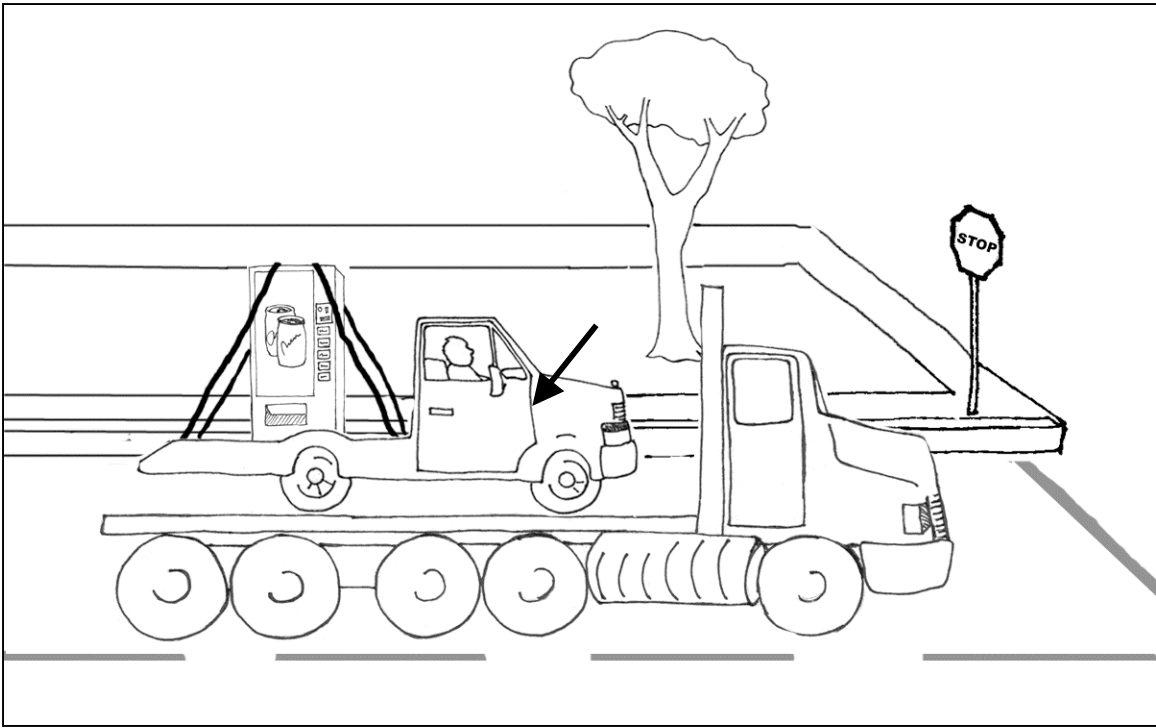

Problem 11-2a

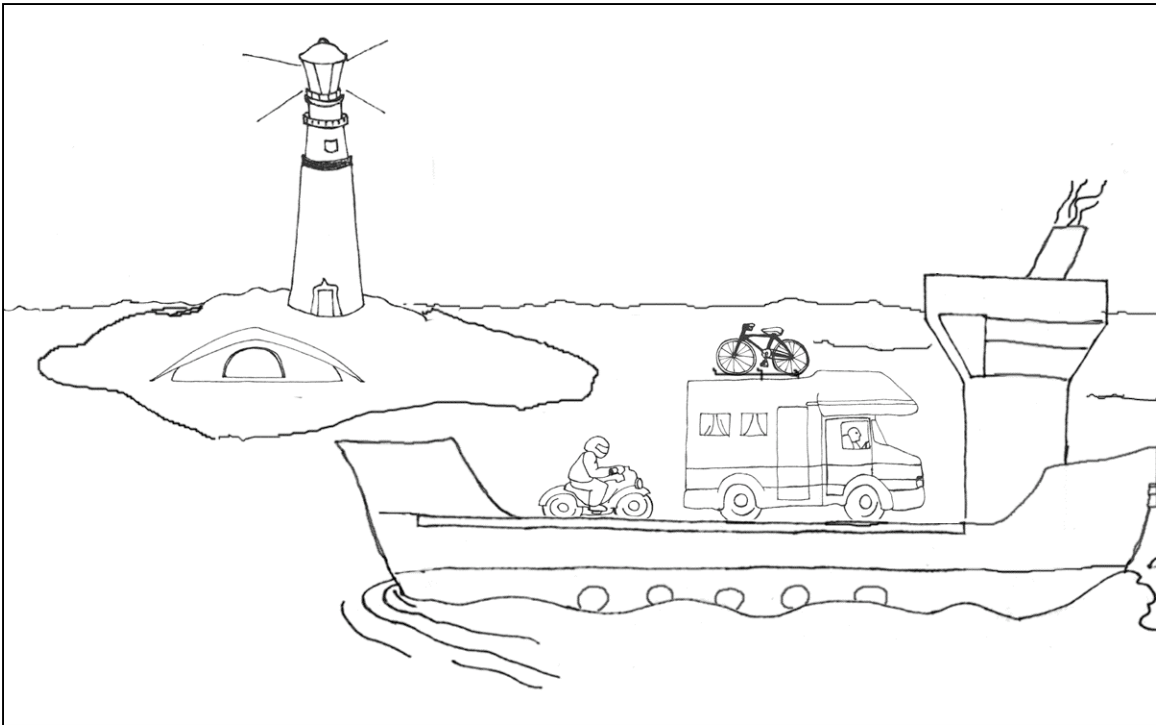
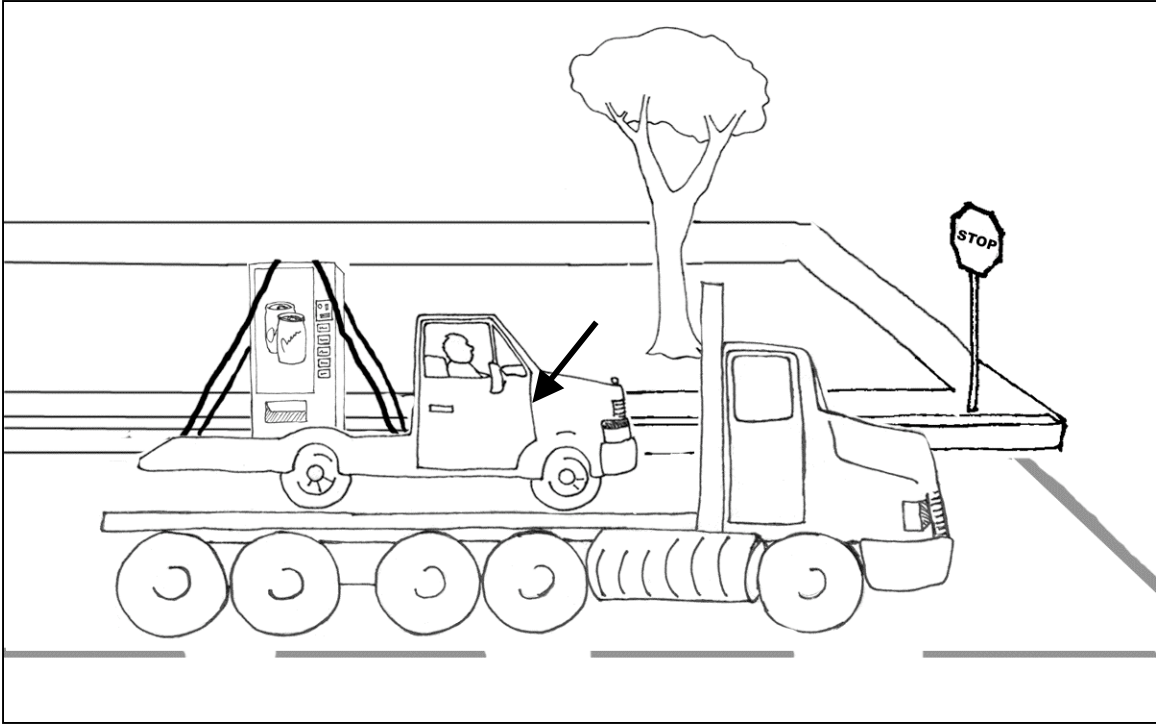

Problem 11-2b

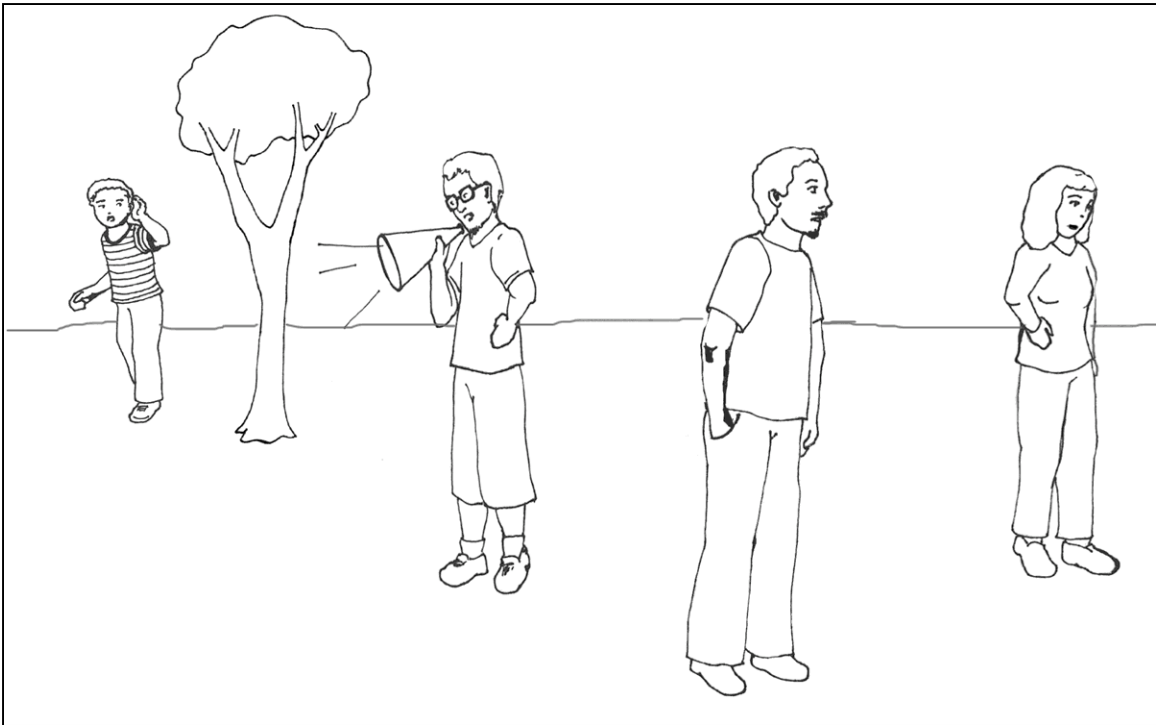
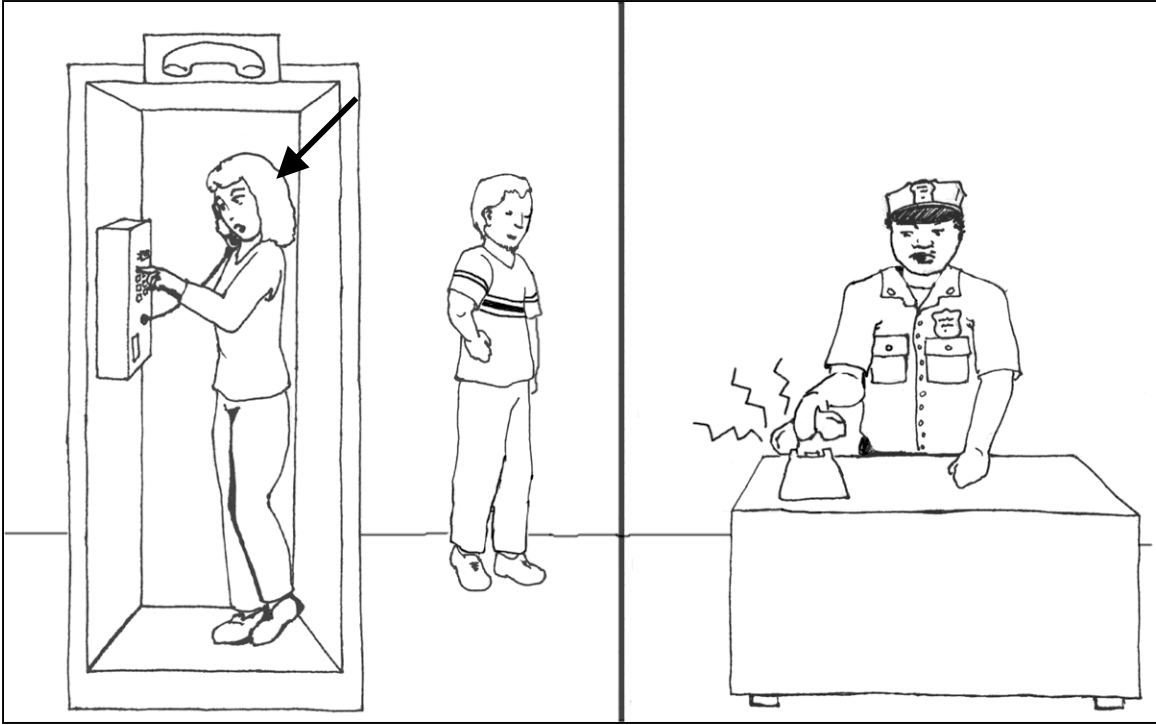

Problem 12-1a

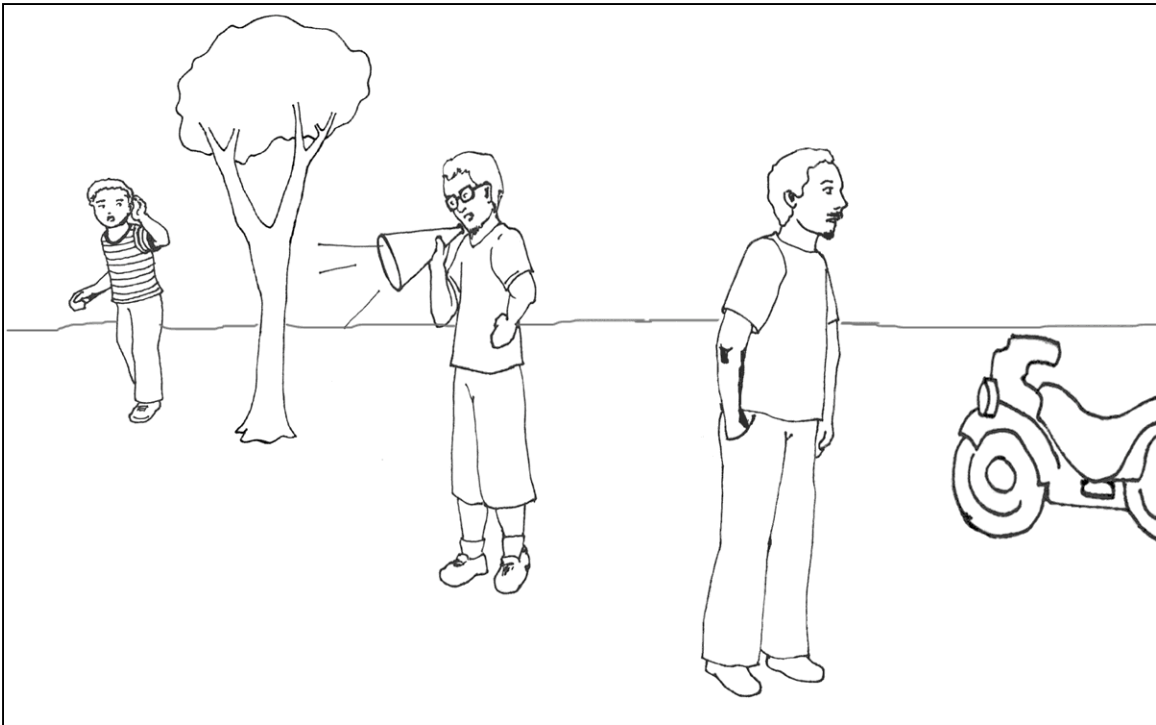

Problem 12-1b

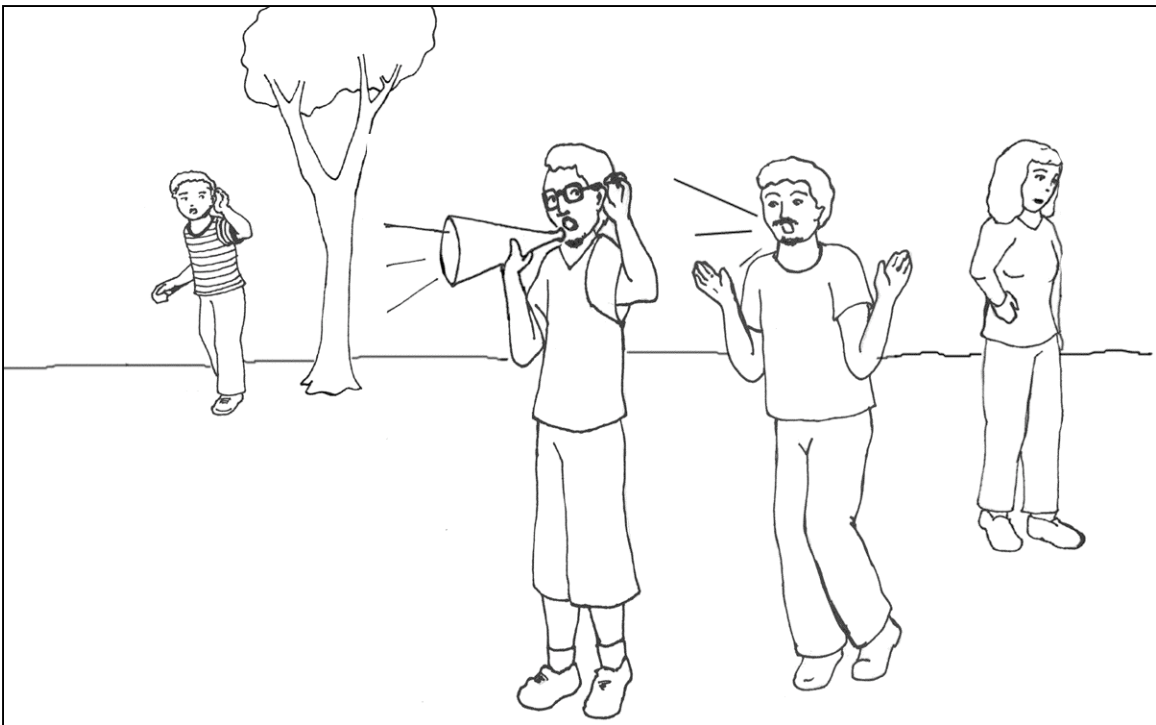

Problem 12-2a

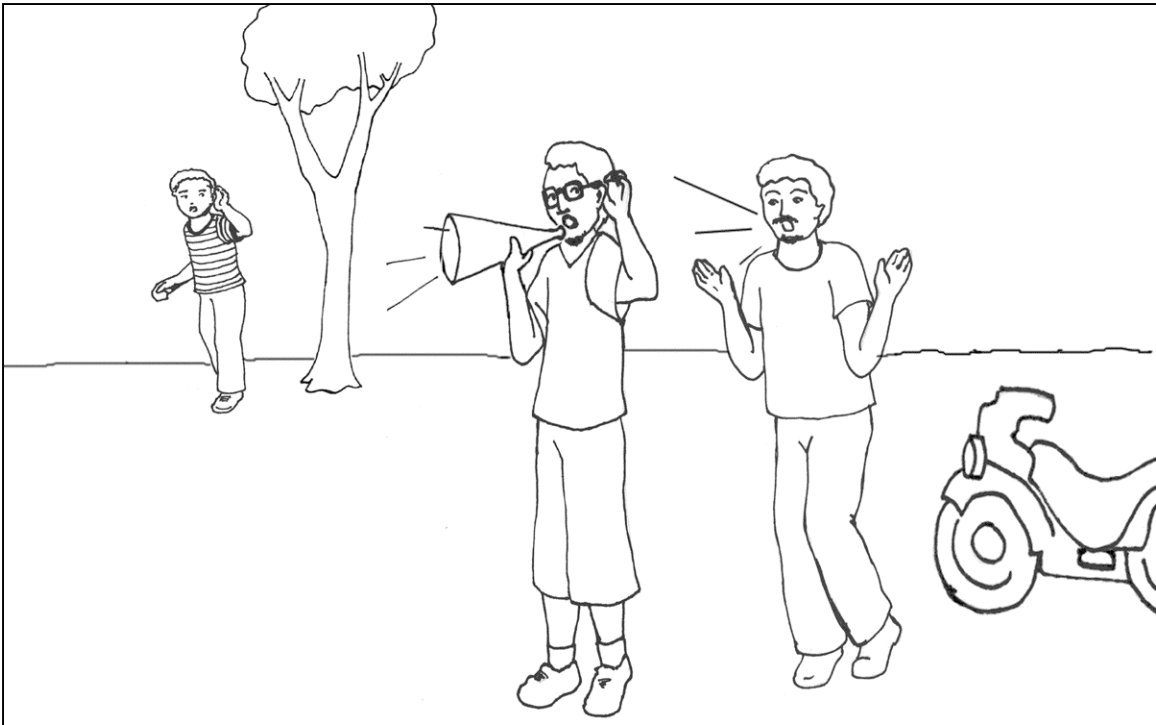

Problem 12-2b

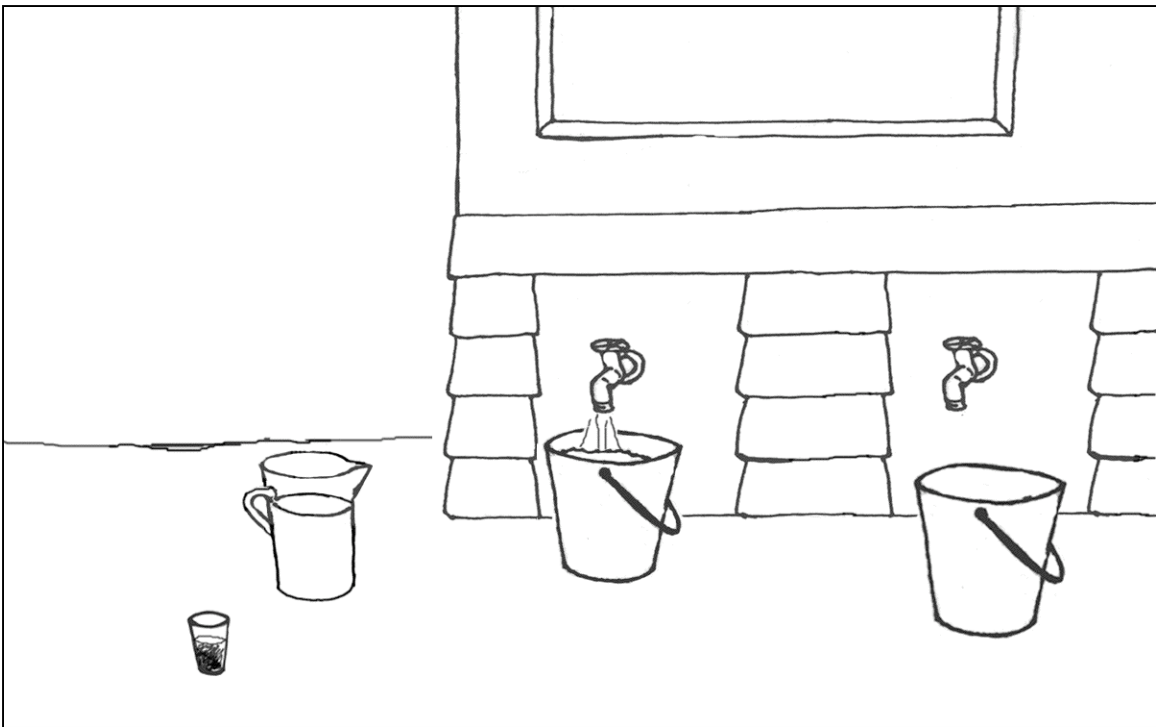
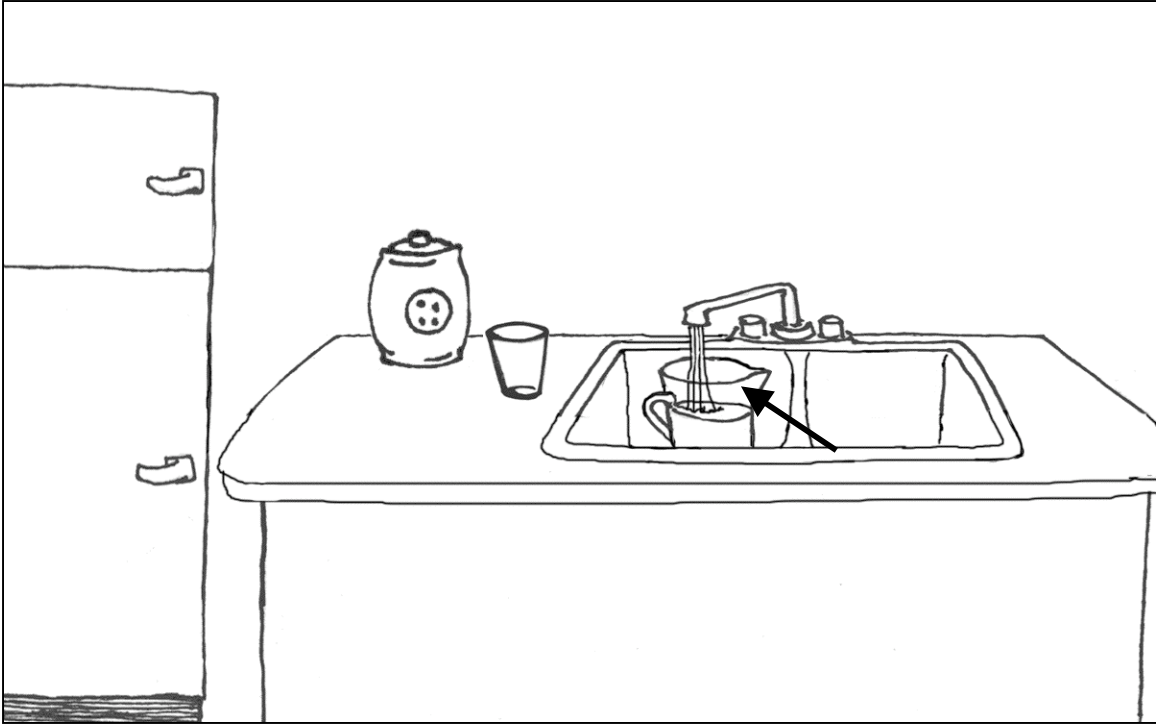

Problem 13-1a

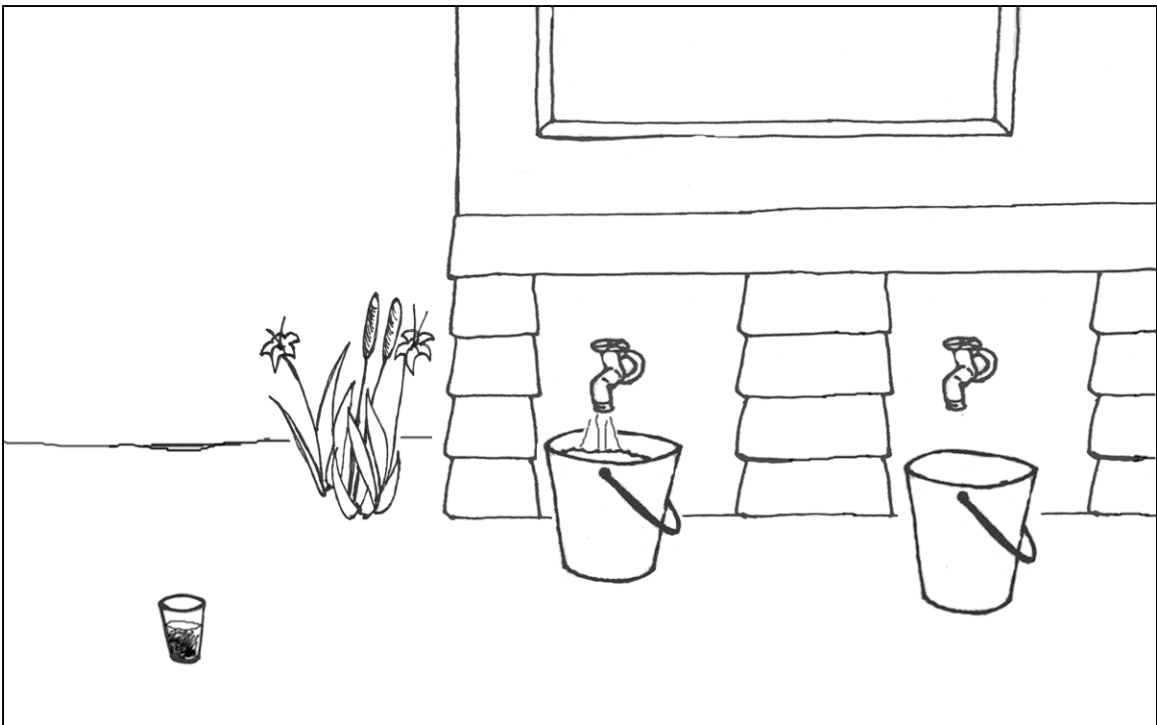
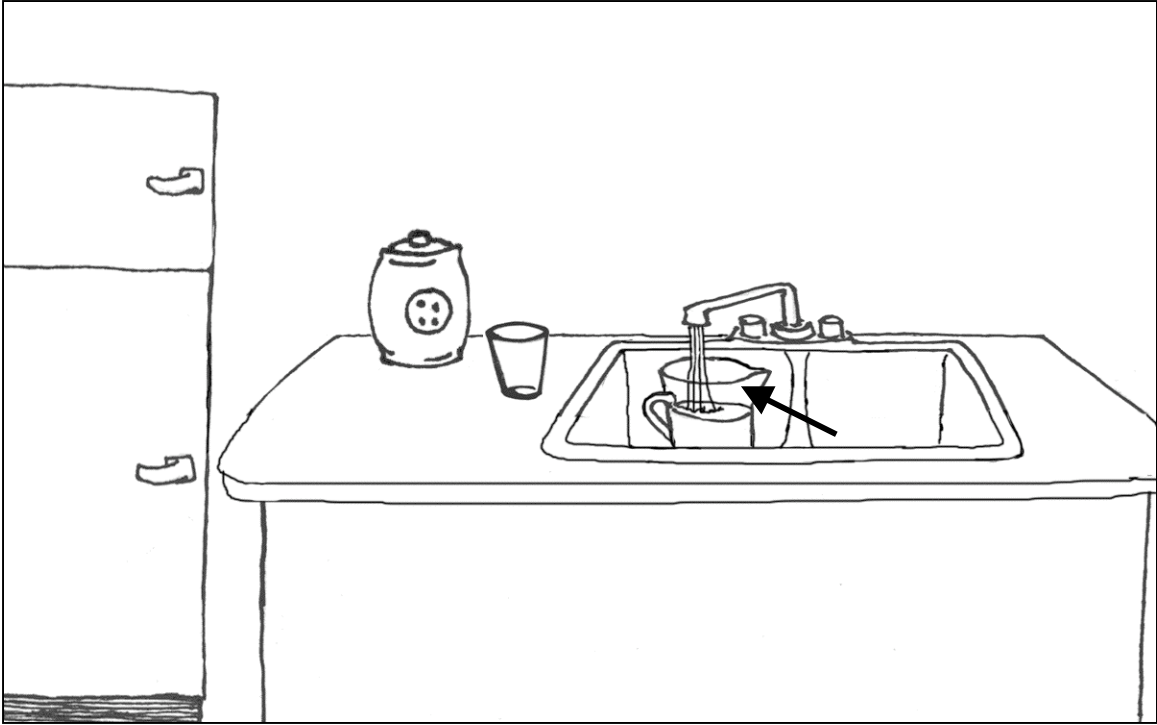

Problem 13-1b

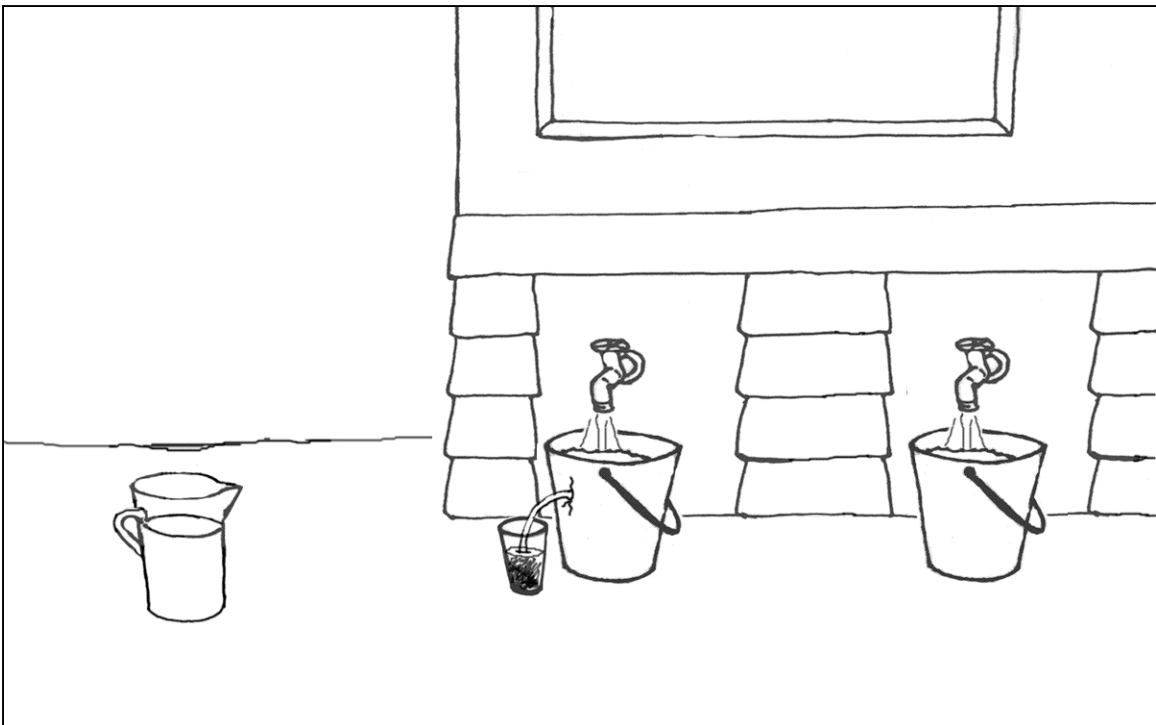
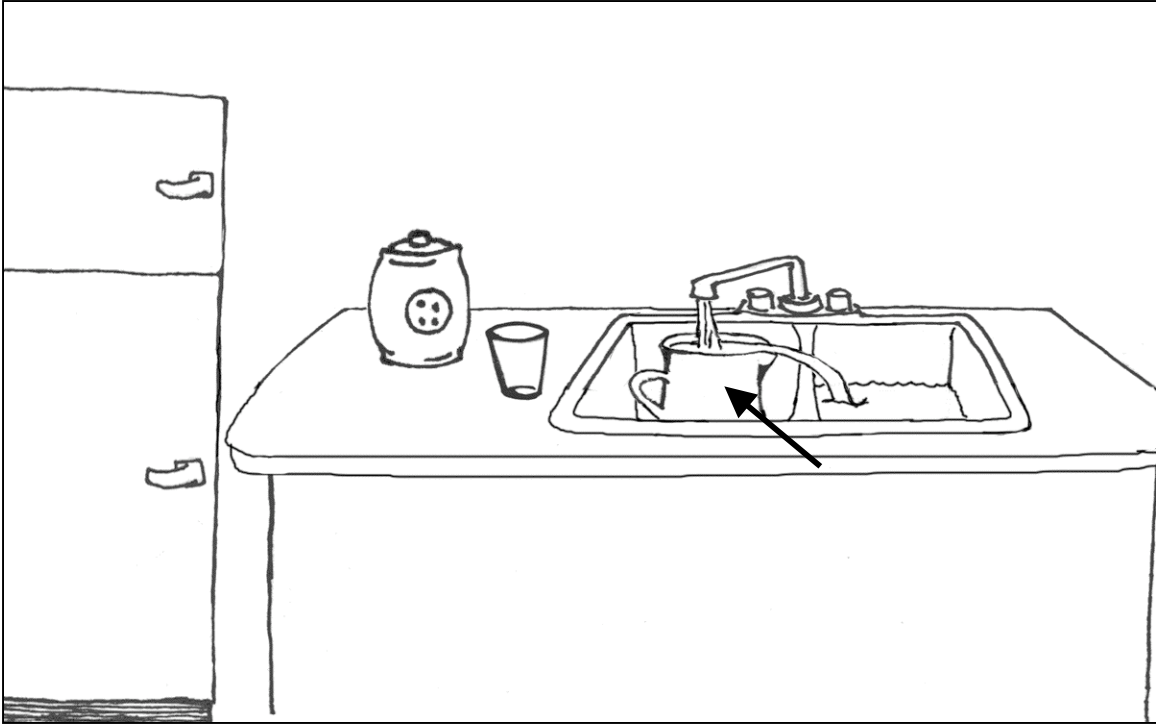

Problem 13-2a

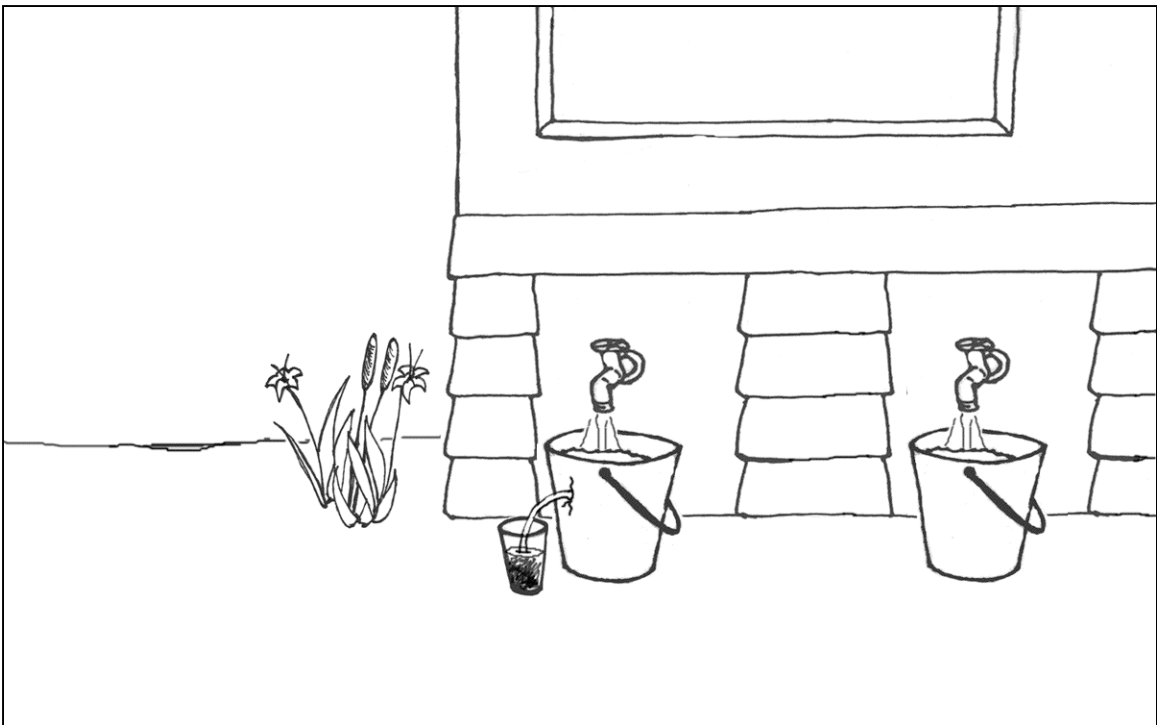
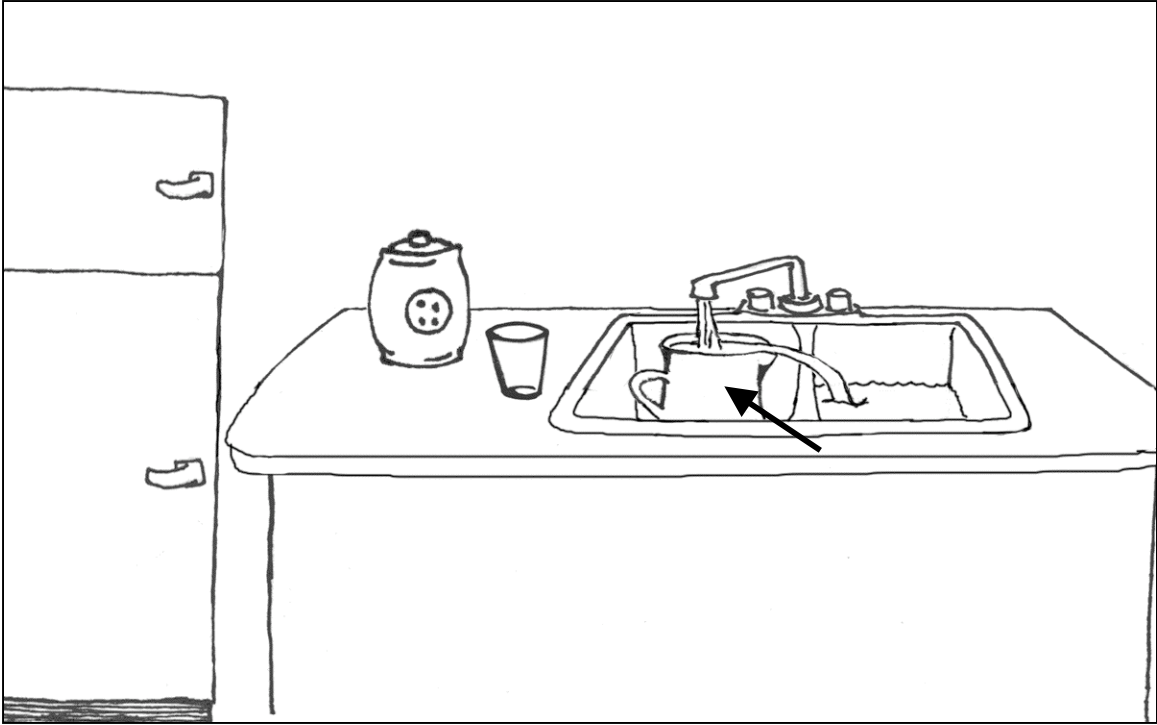

Problem 13-2b

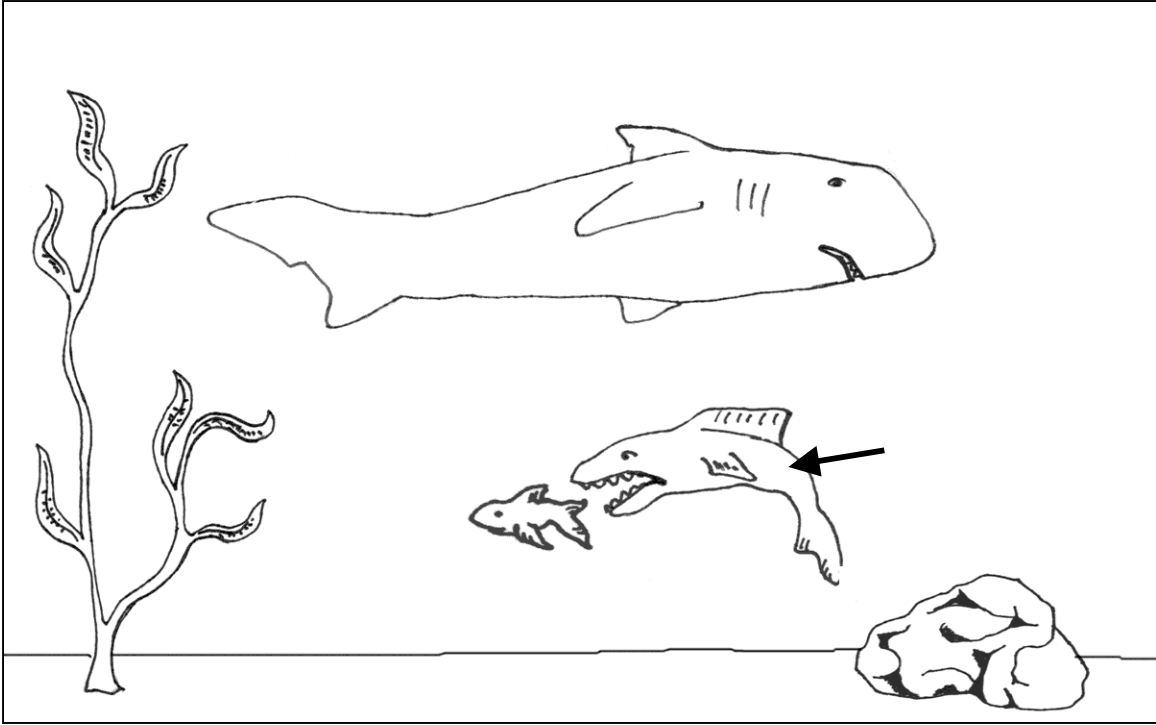

Problem 14-1a

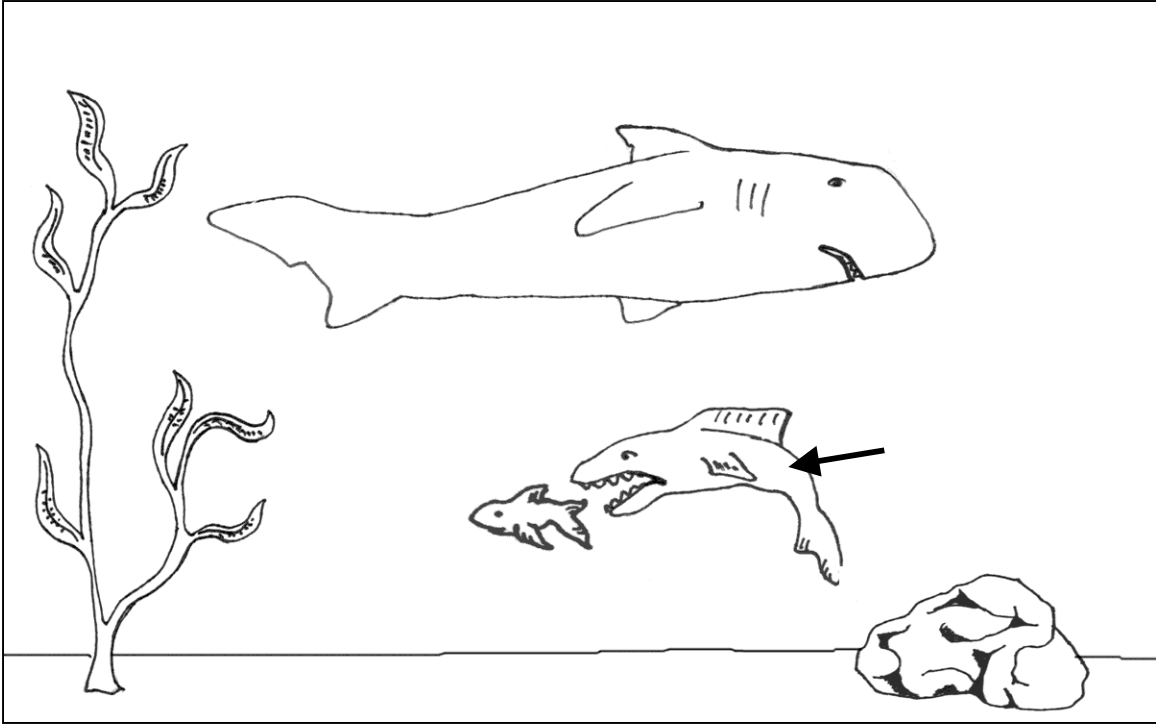

Problem 14-1b

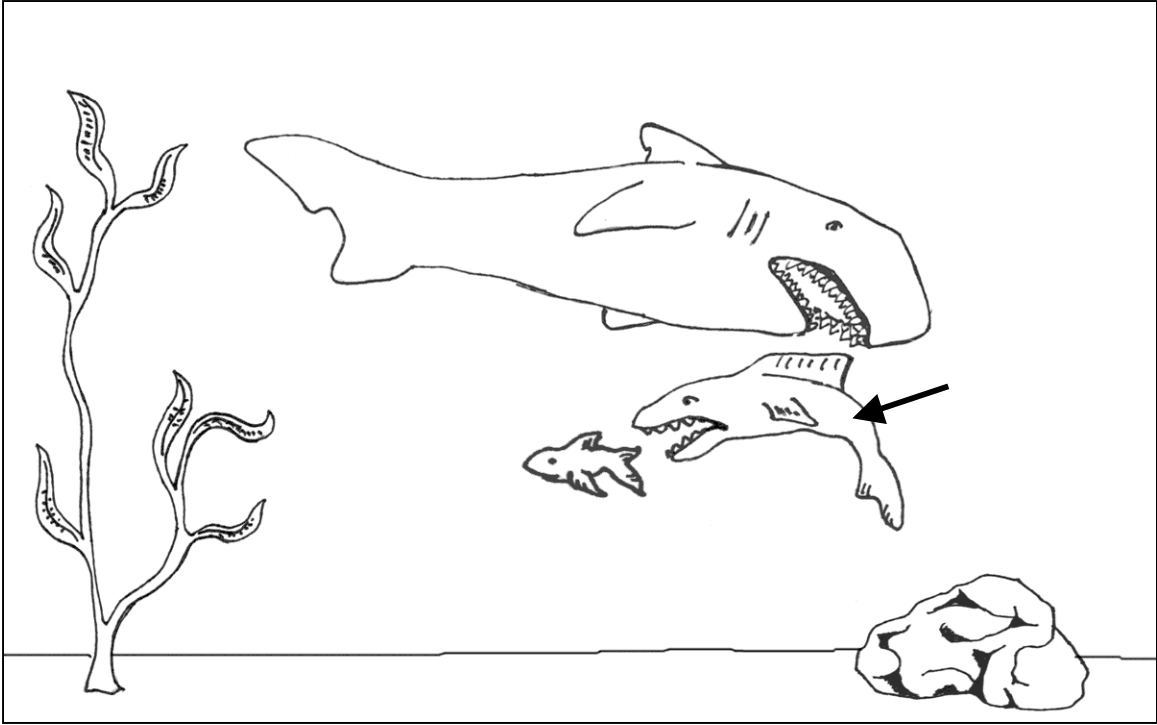

Problem 14-2a

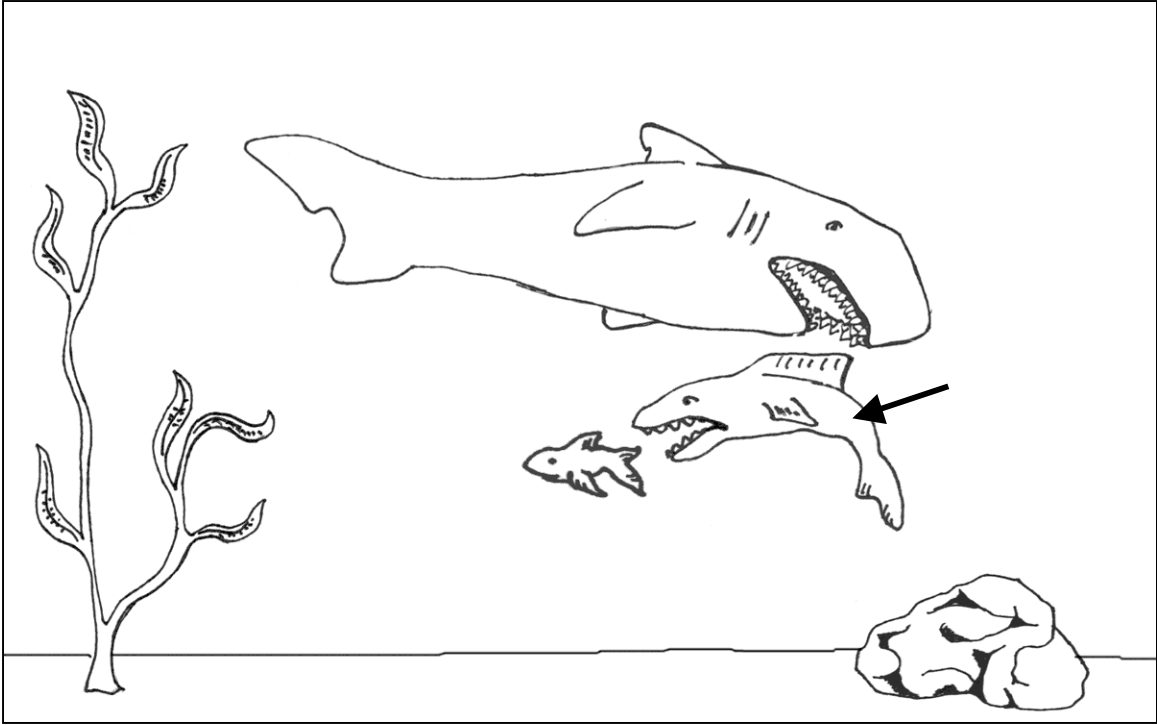

Problem 14-2b

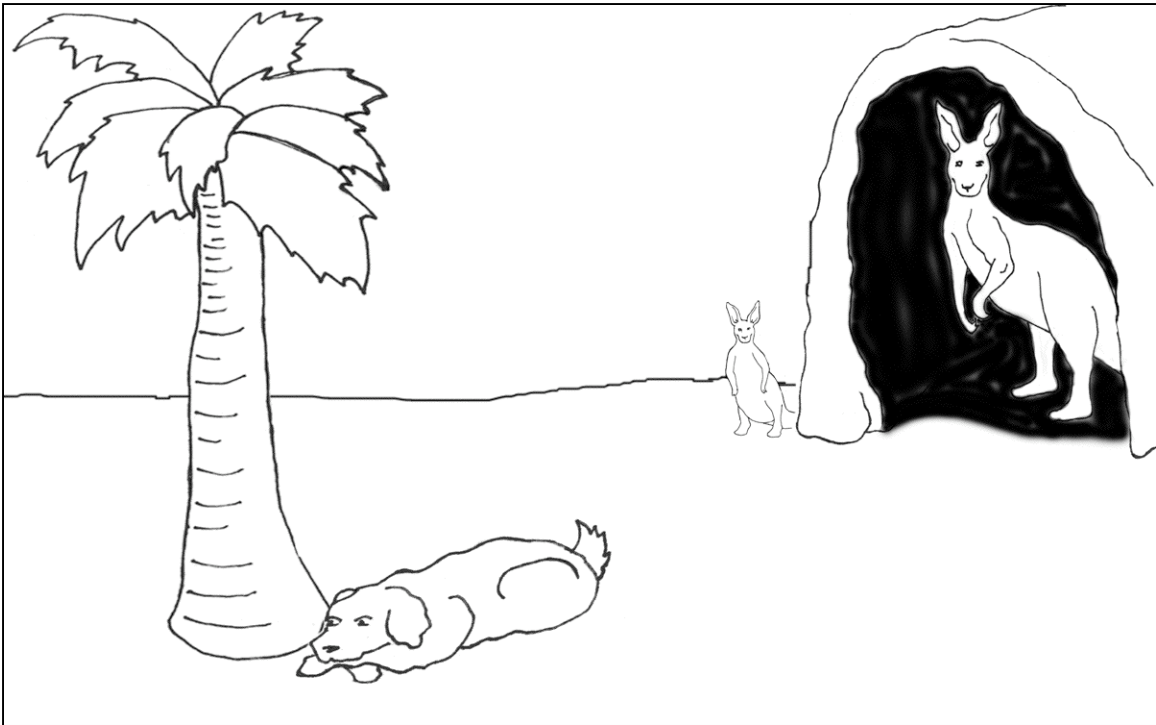
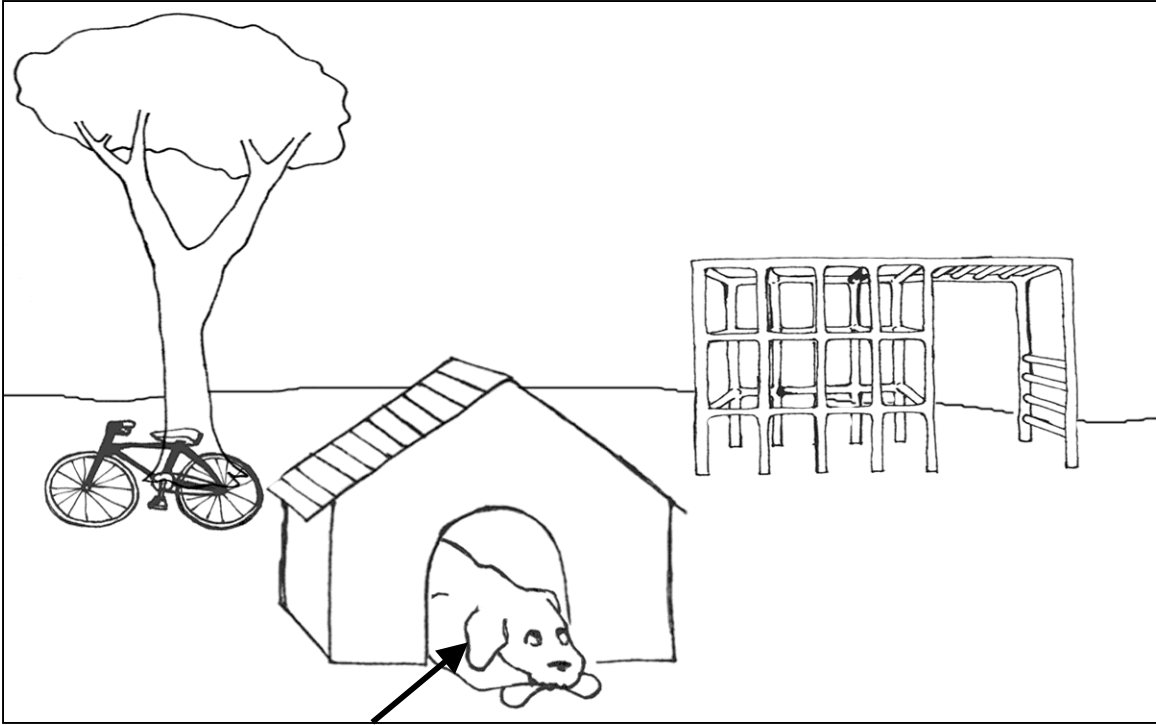

Problem 15-1a

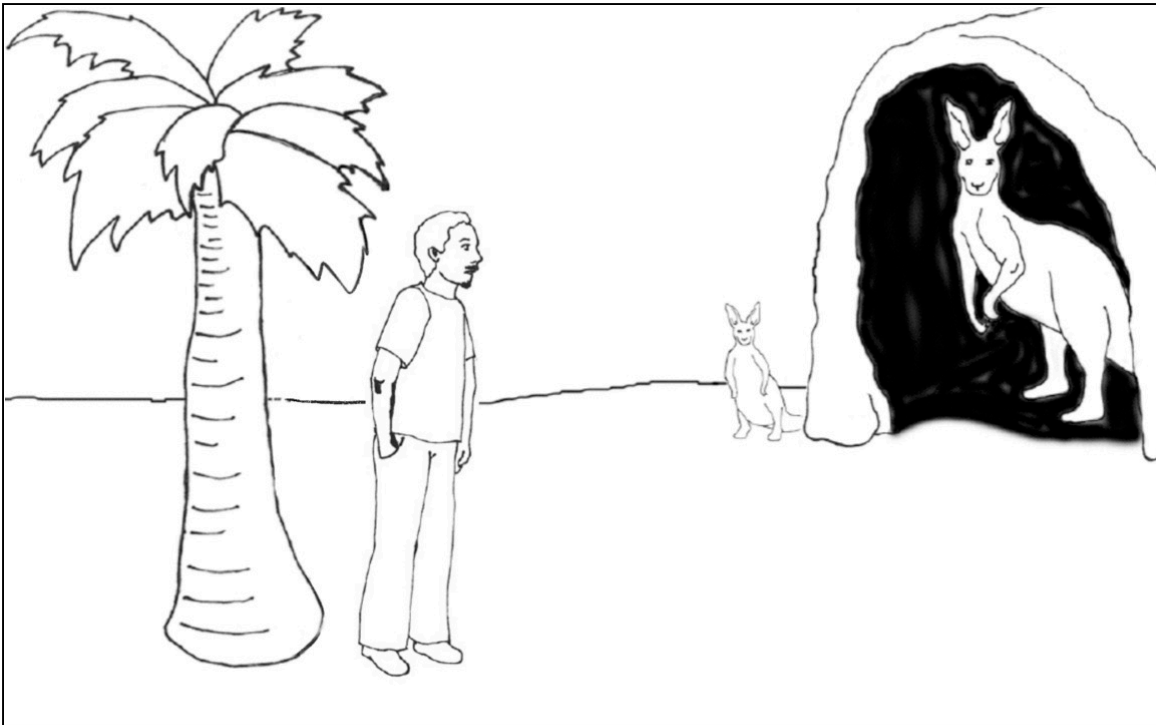
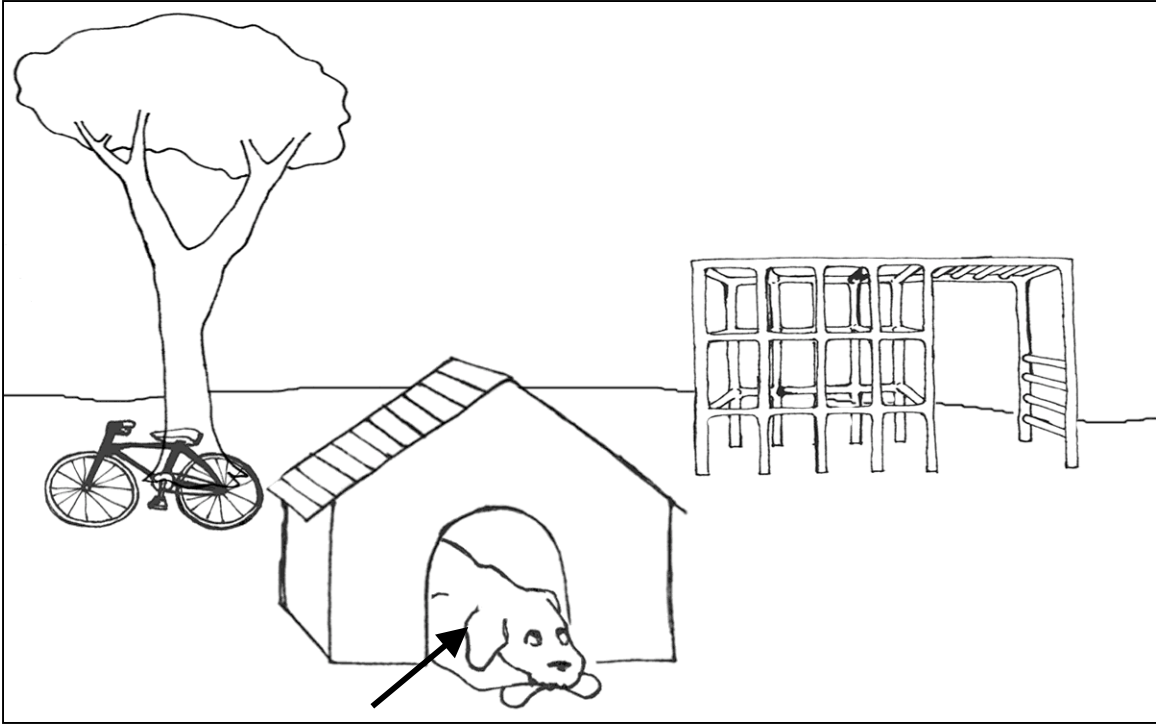

Problem 15-1b

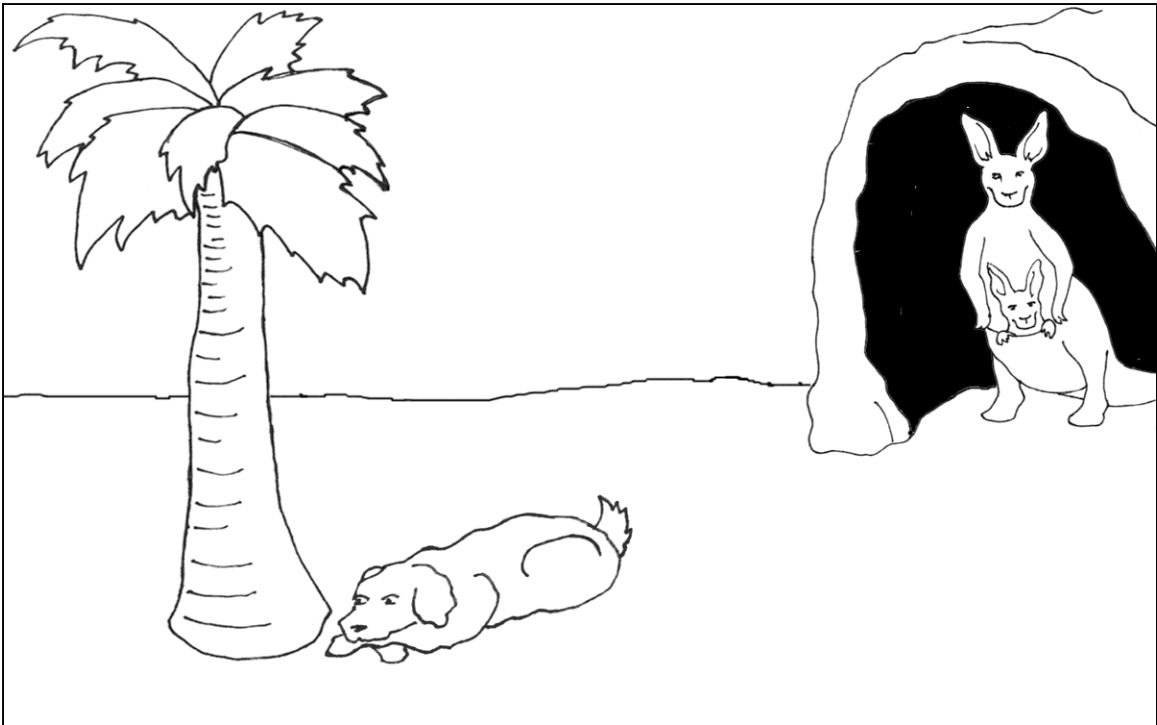
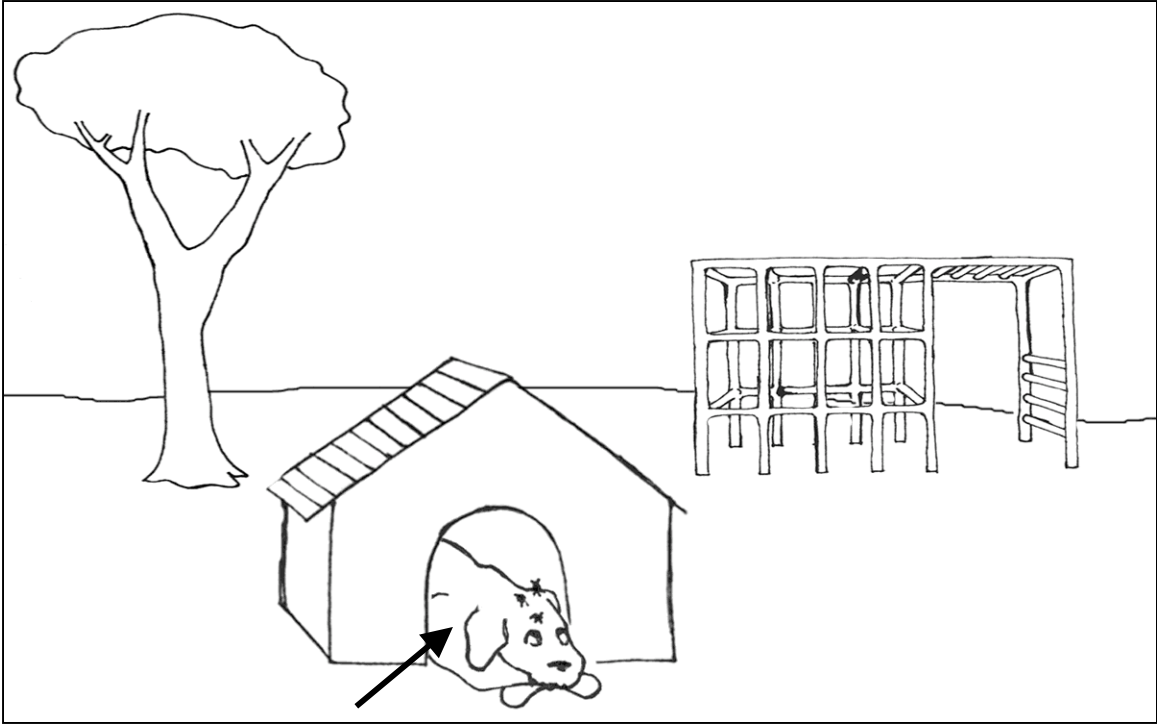

Problem 15-2a

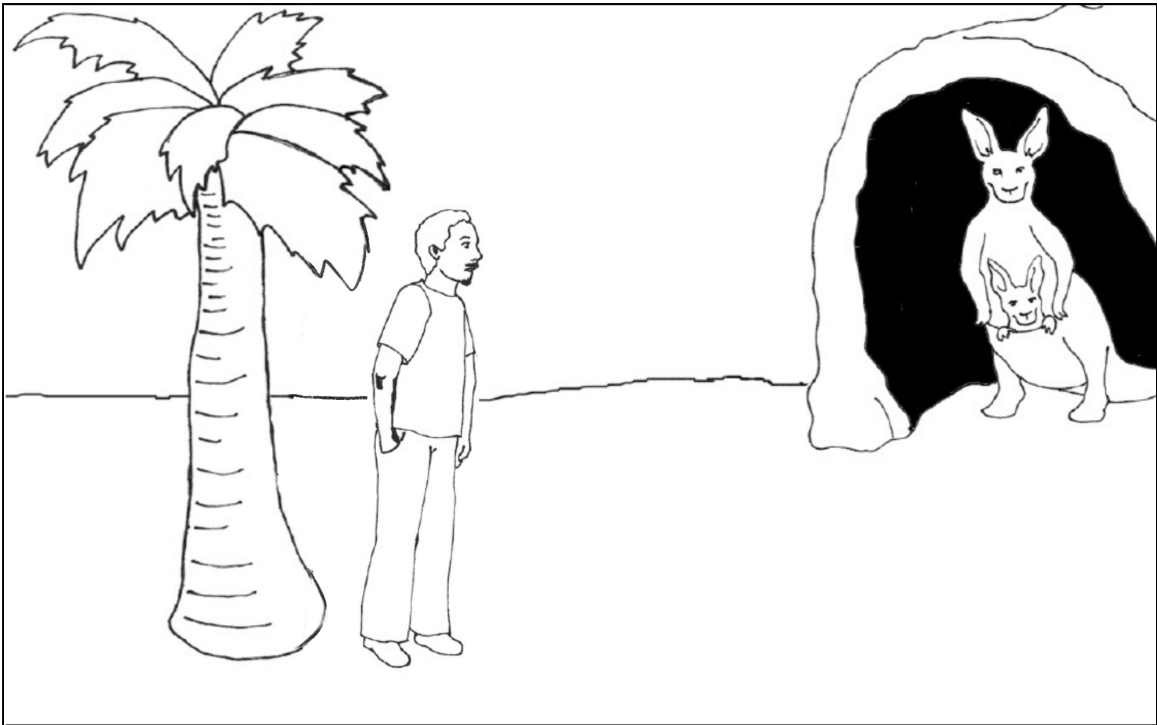
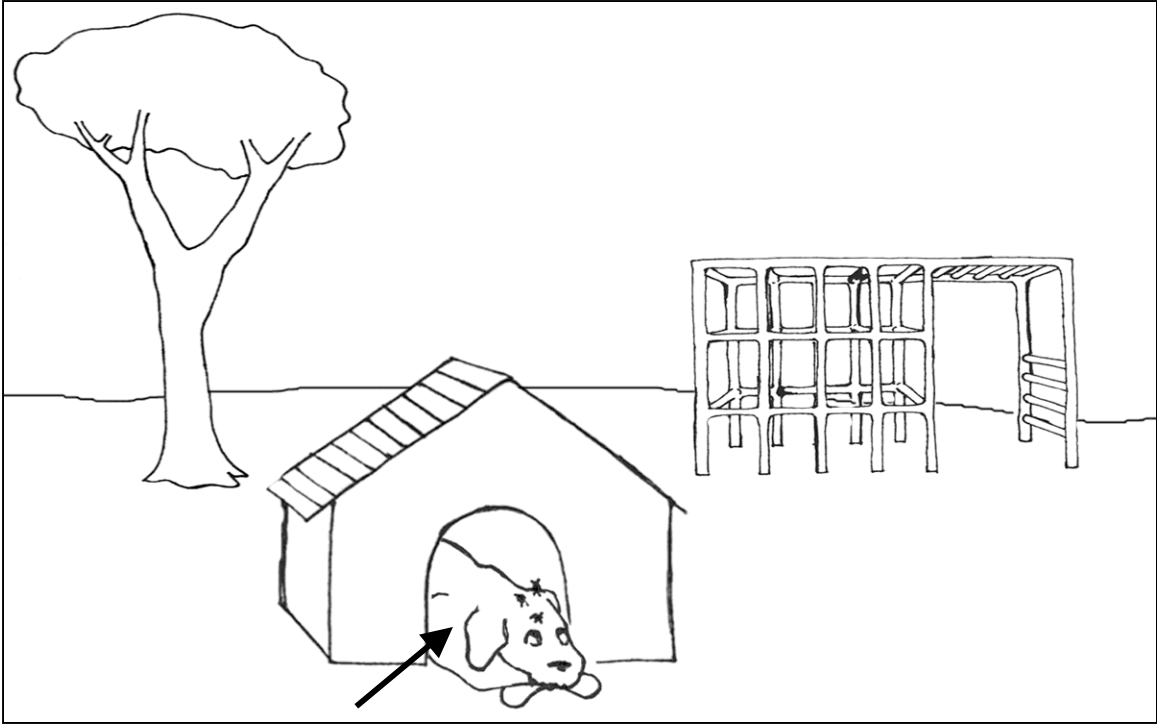

Problem 15-2b

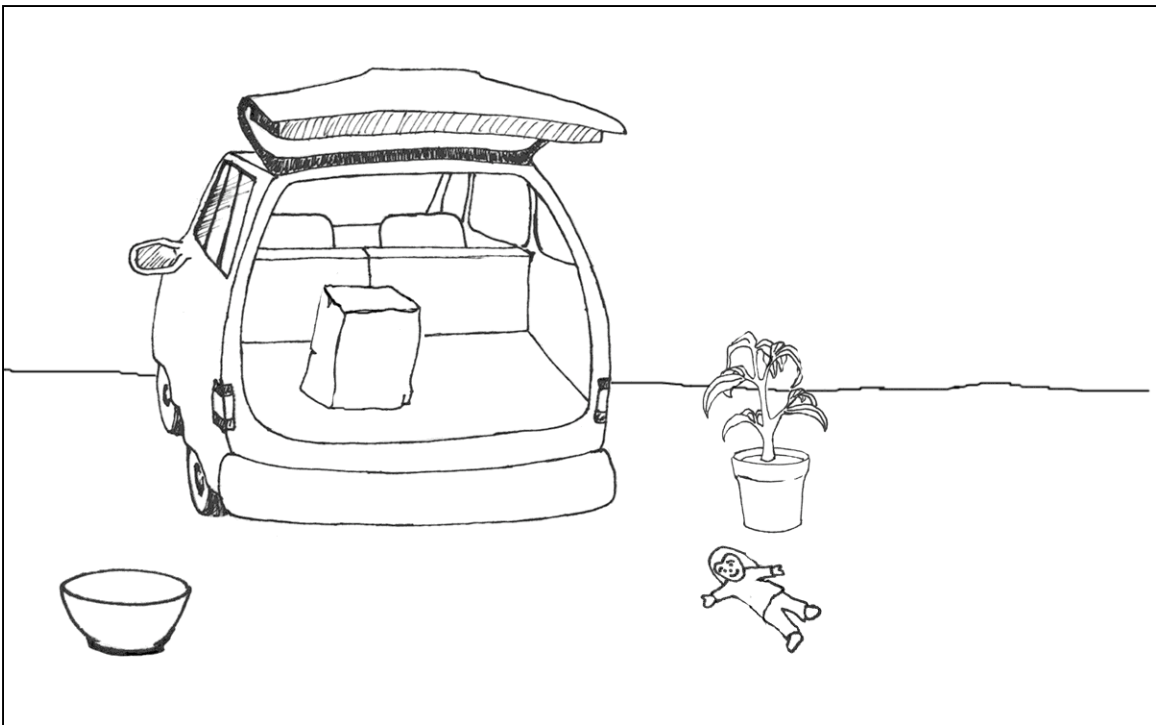
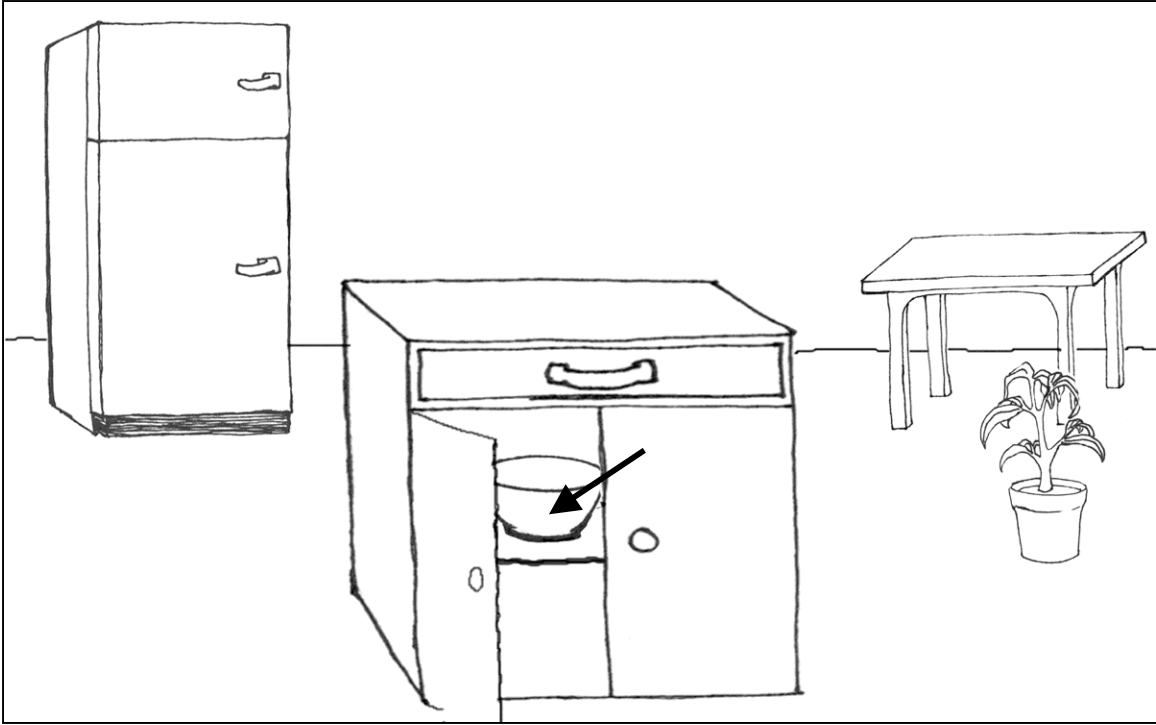

Problem 16-1a

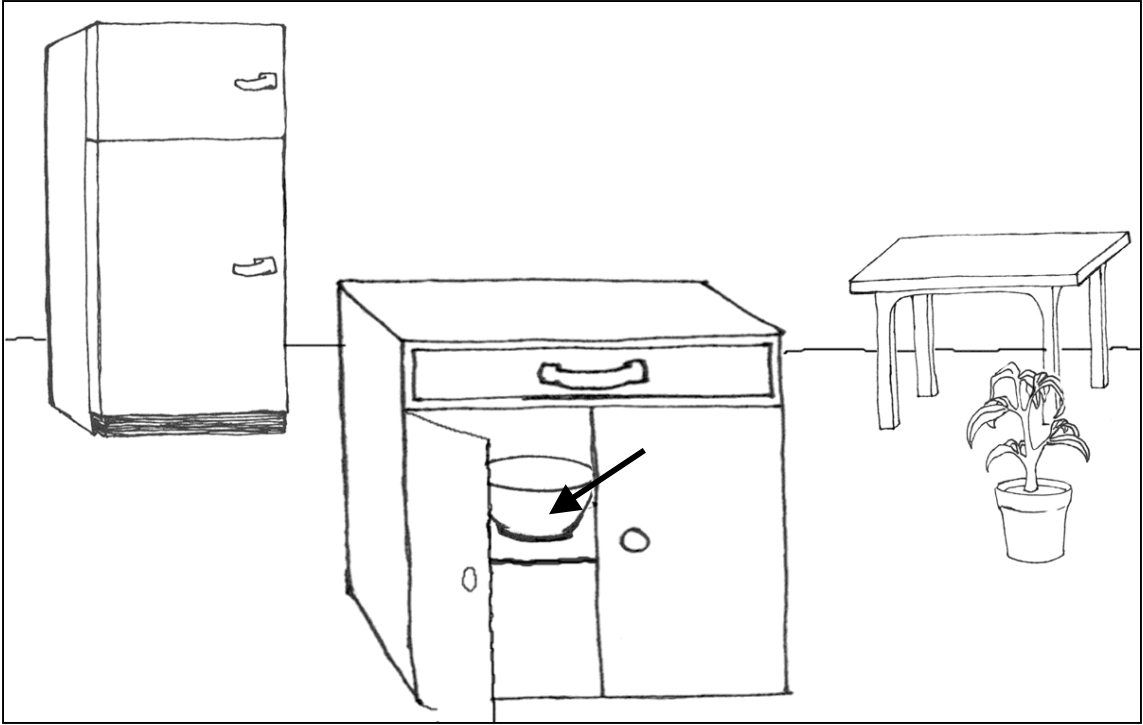

Problem 16-1b

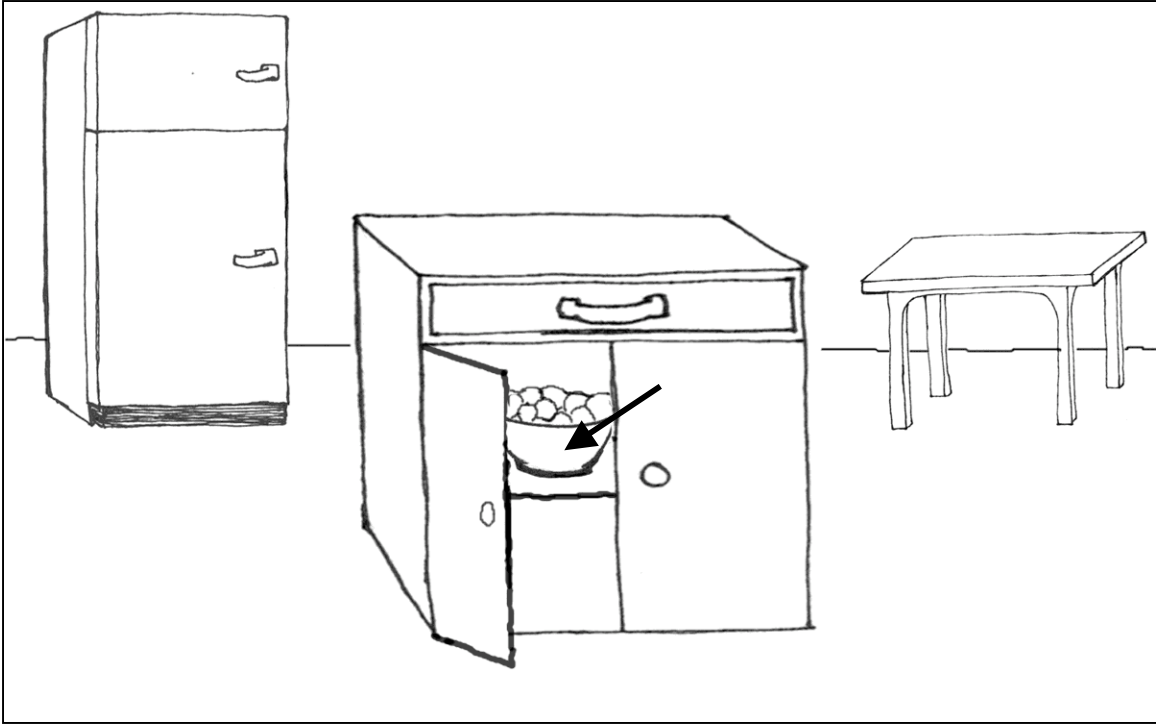

Problem 16-2a

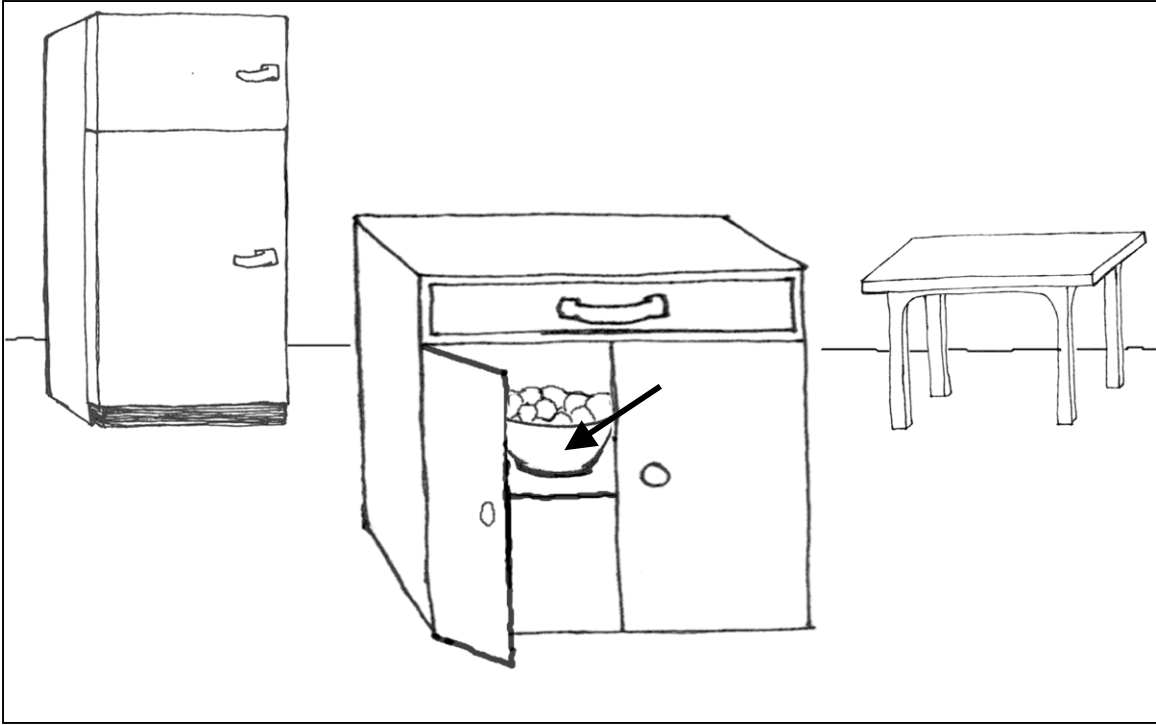

Problem 16-2b

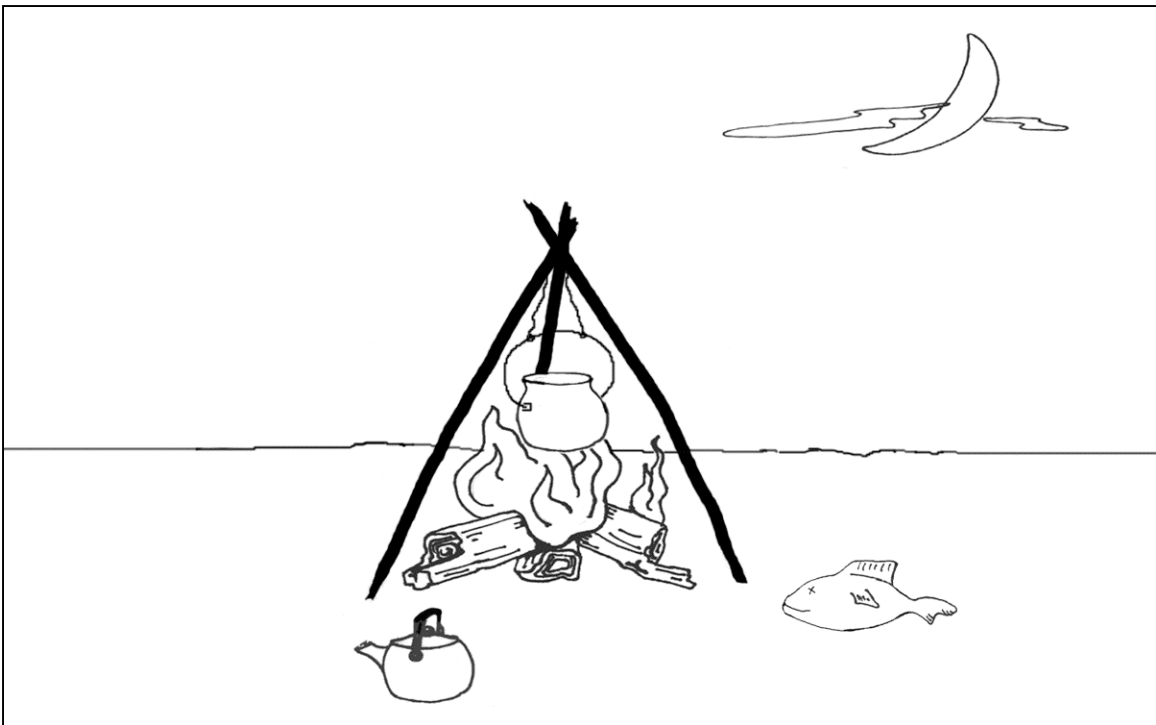
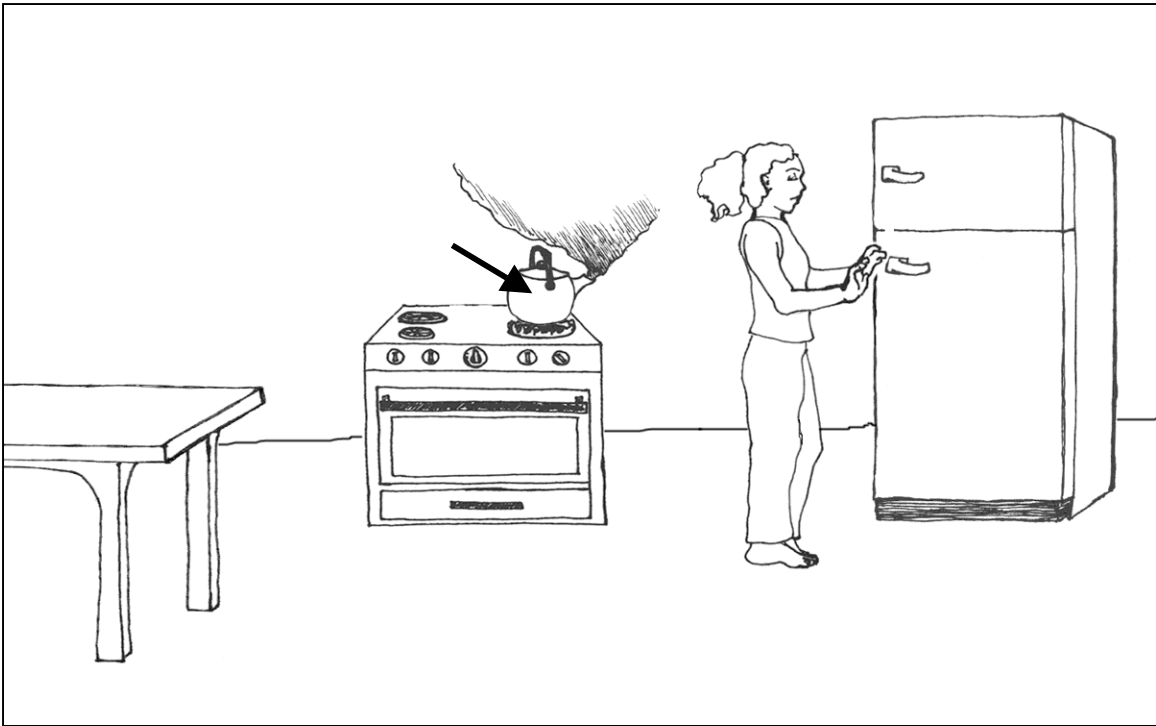

Problem 17-1a

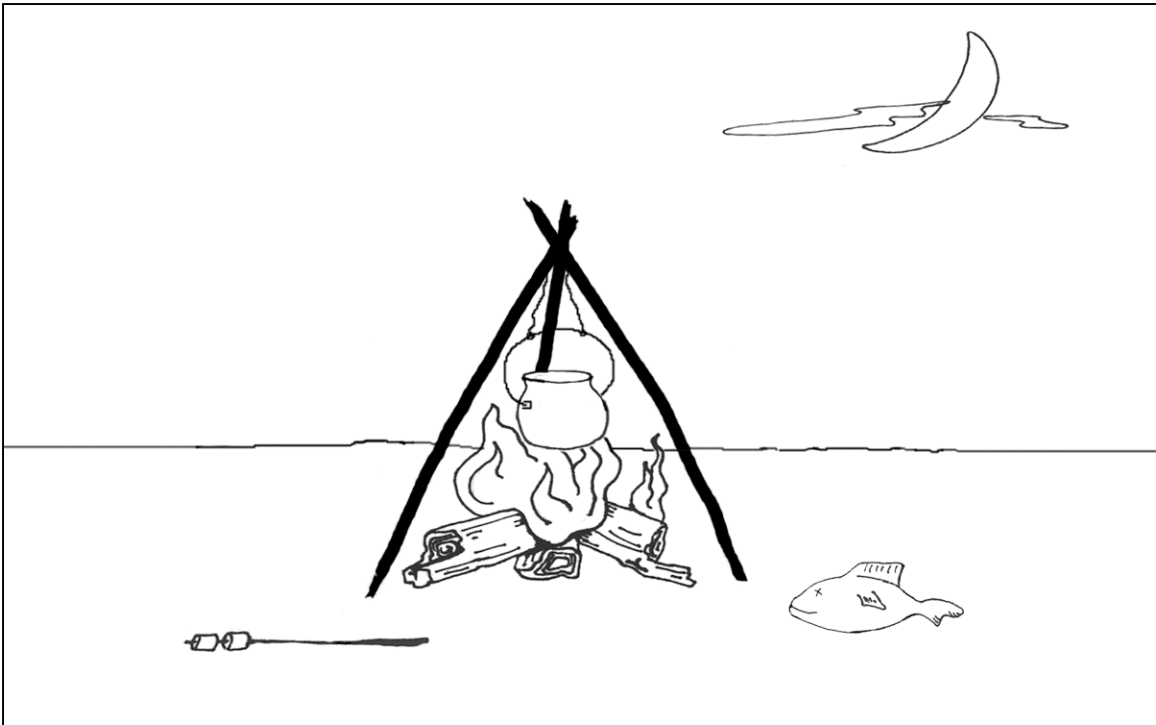
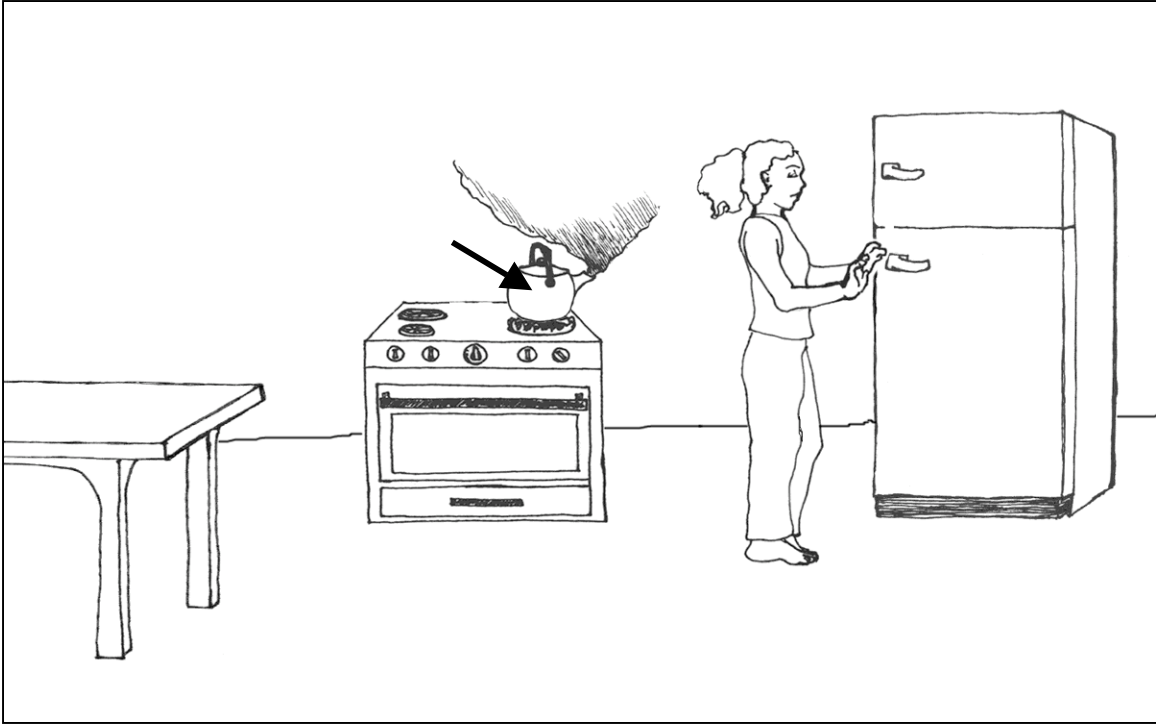

Problem 17-1b

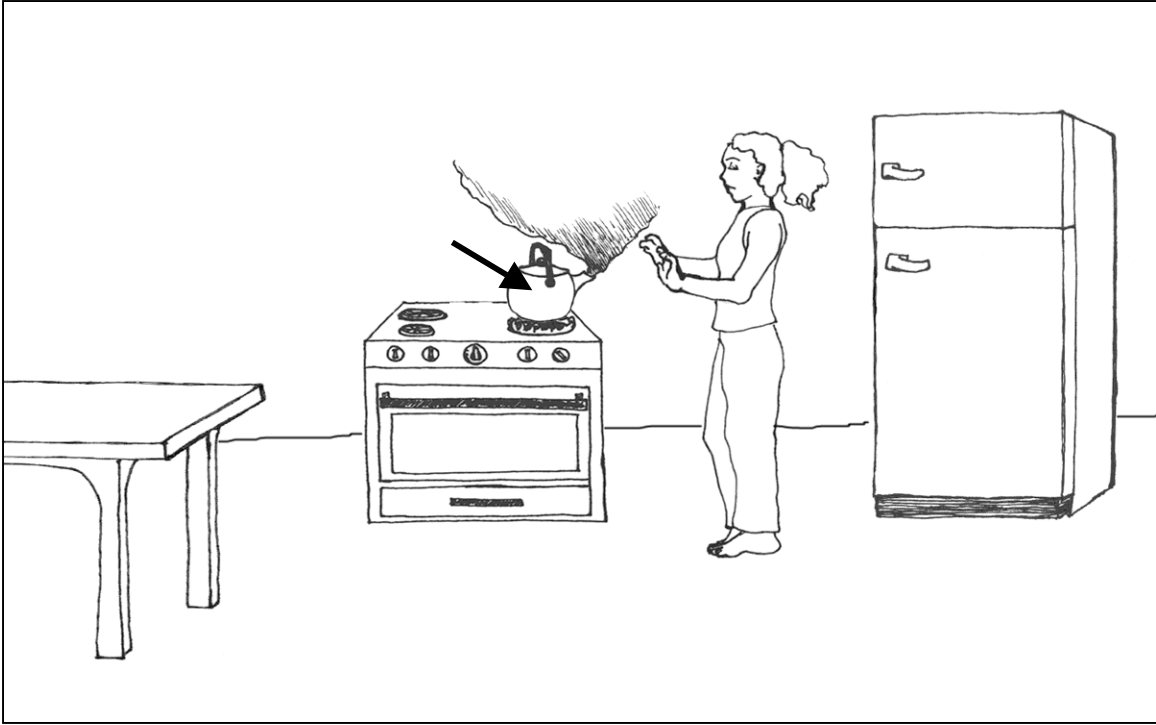

Problem 17-2a

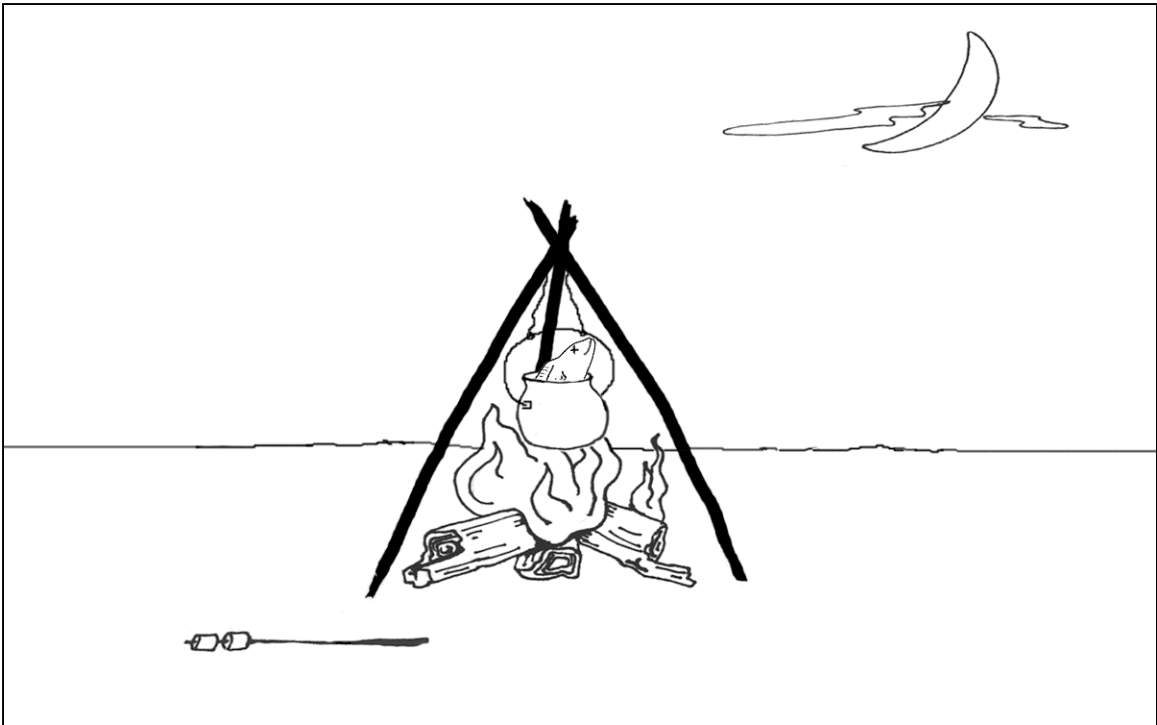
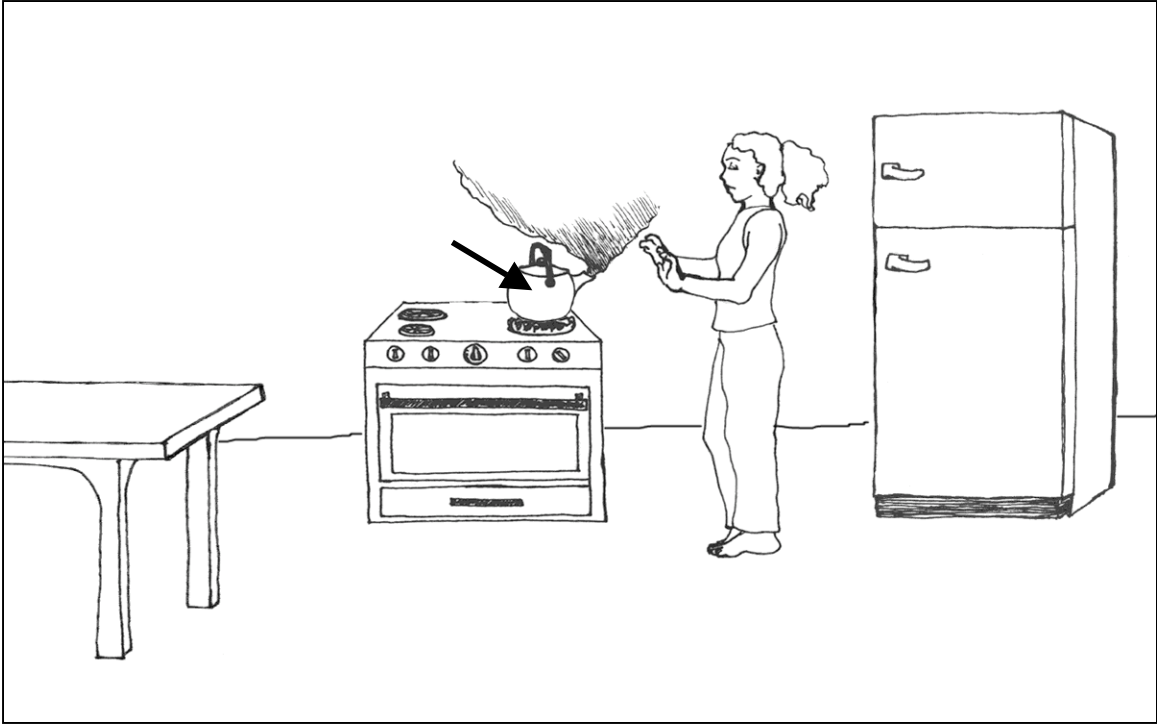

Problem 17-2b

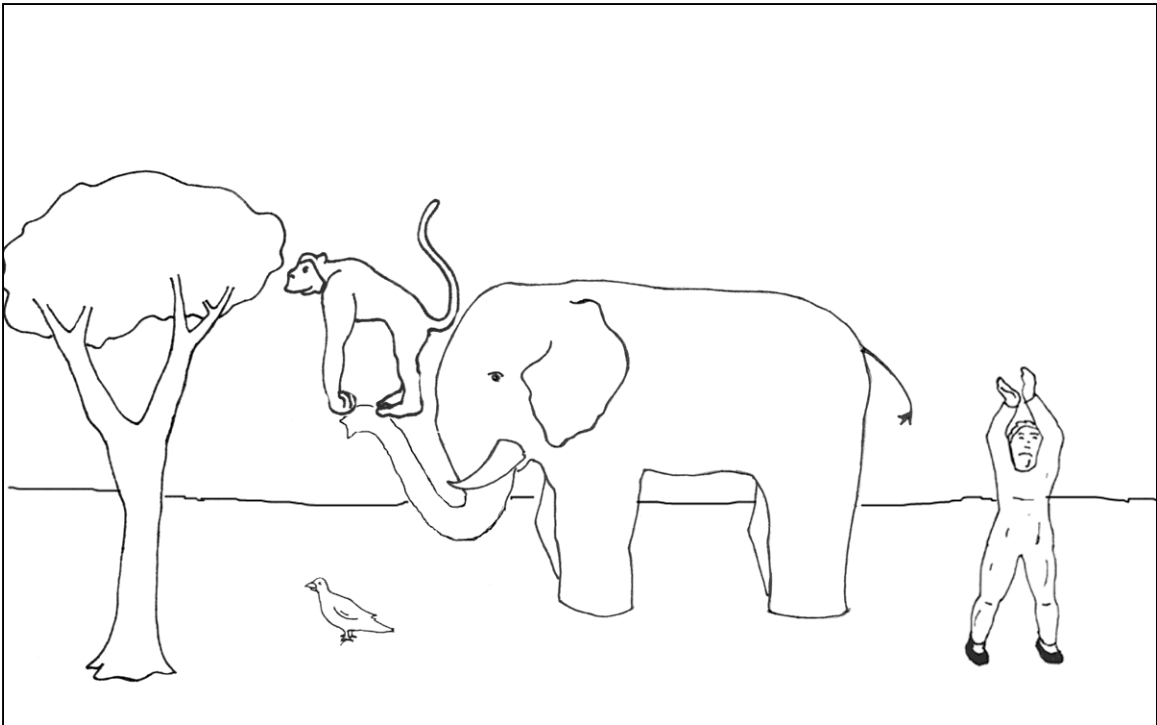
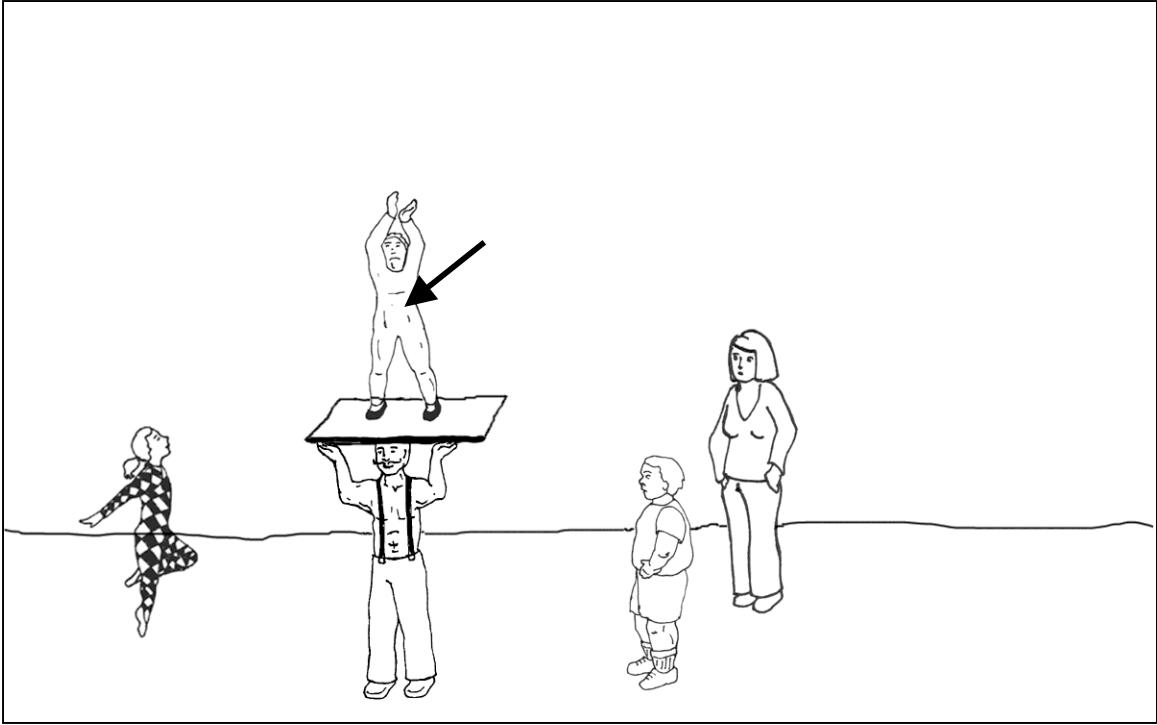

Problem 18-1a

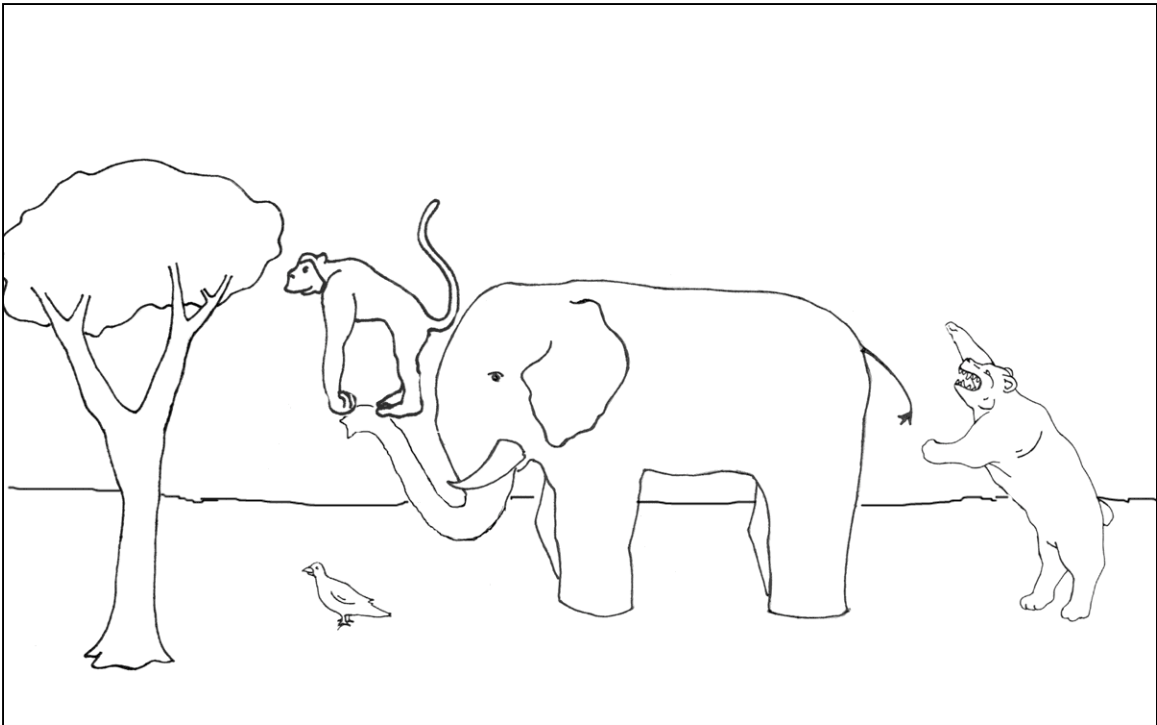
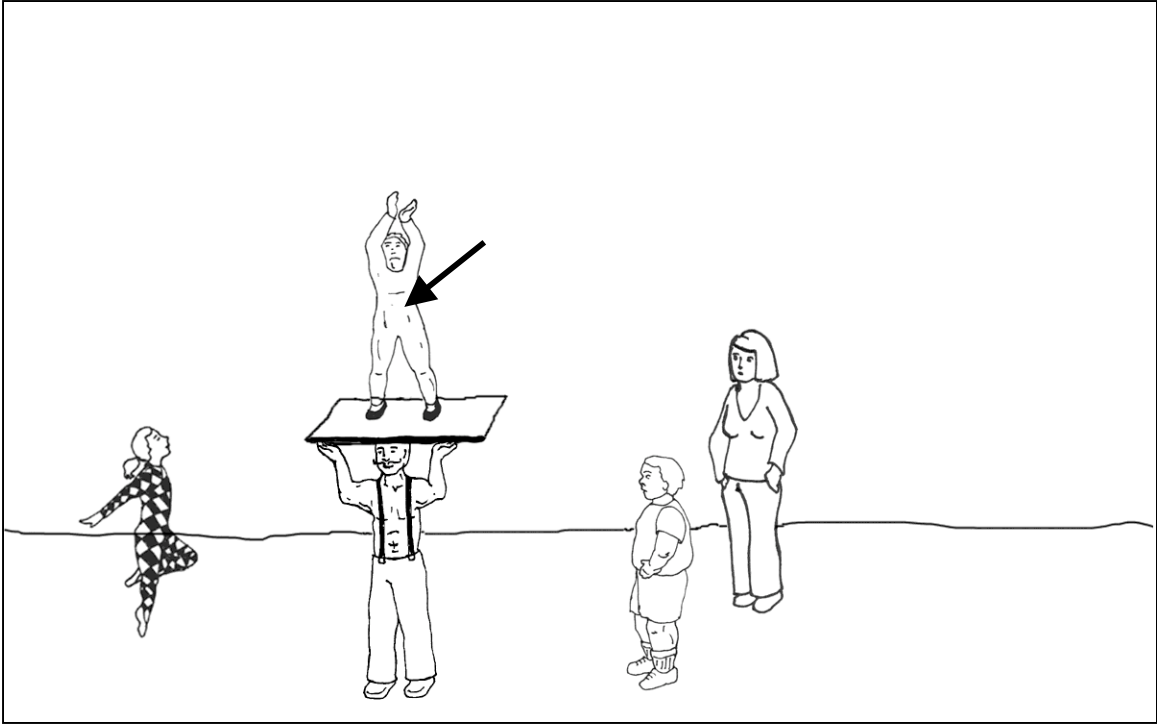

Problem 18-1b

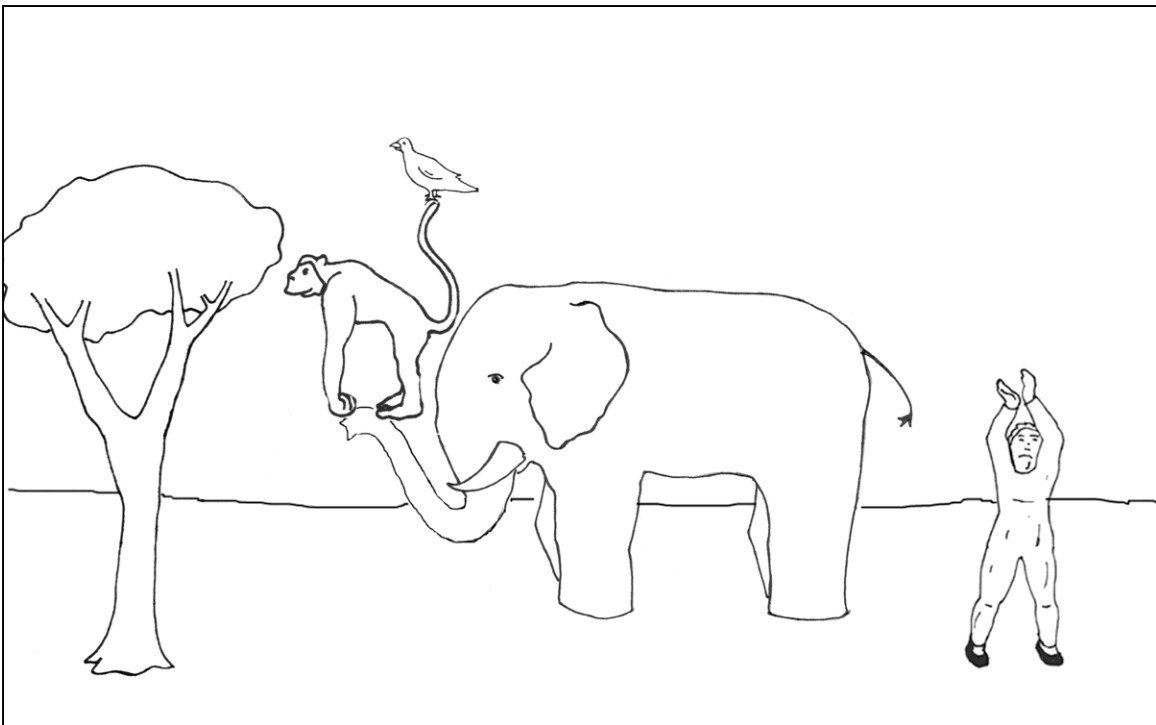
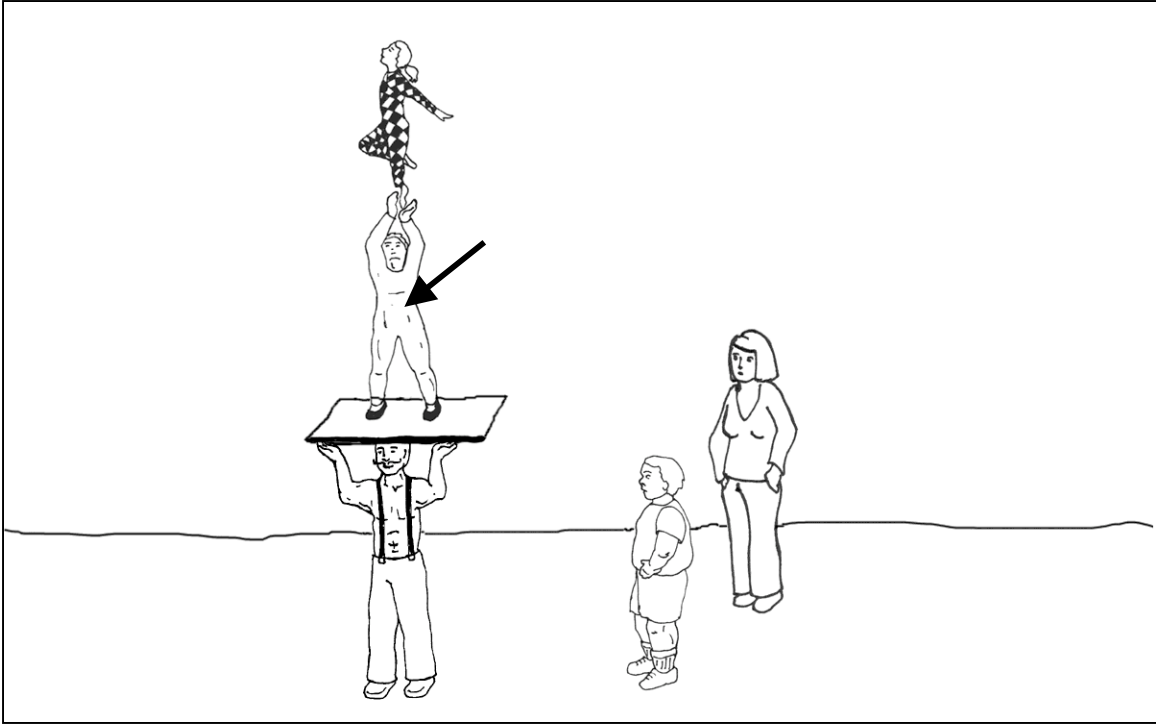

Problem 18-2a

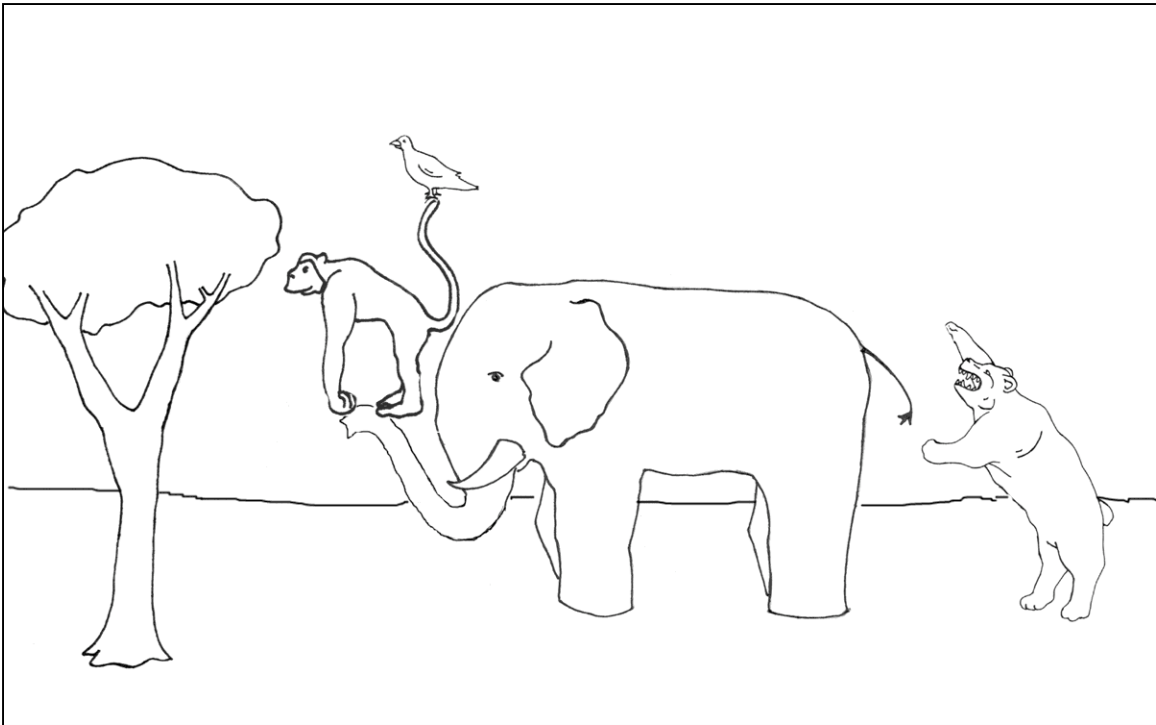
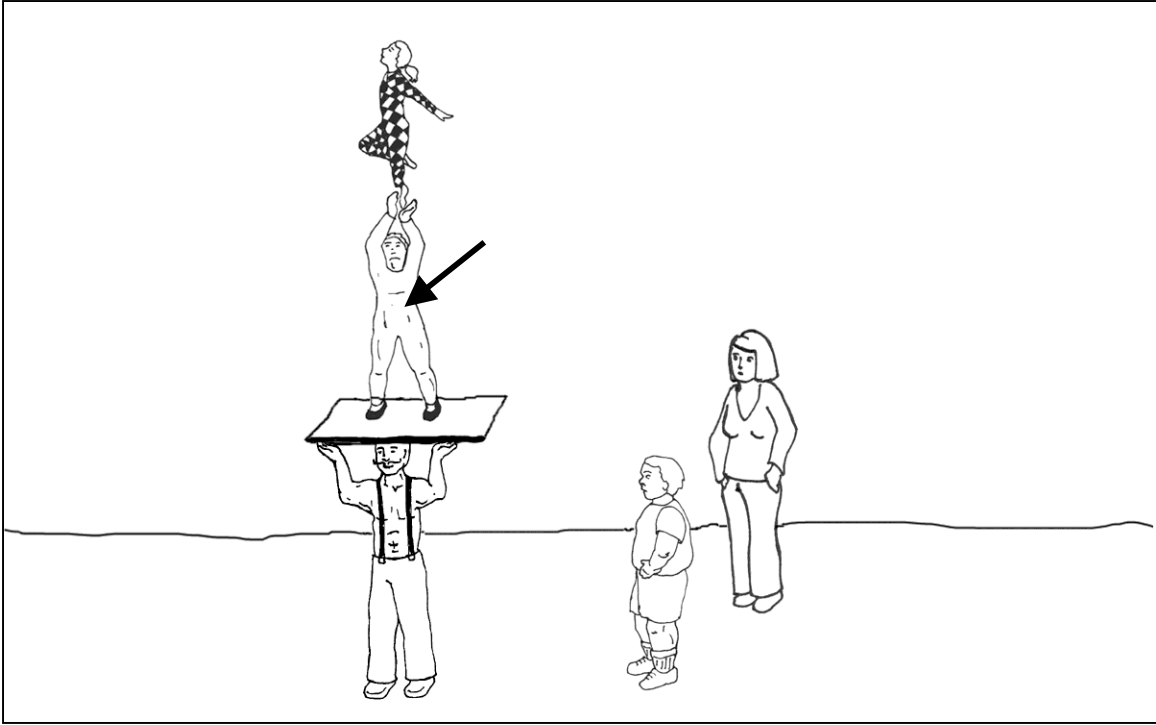

Problem 18-2b

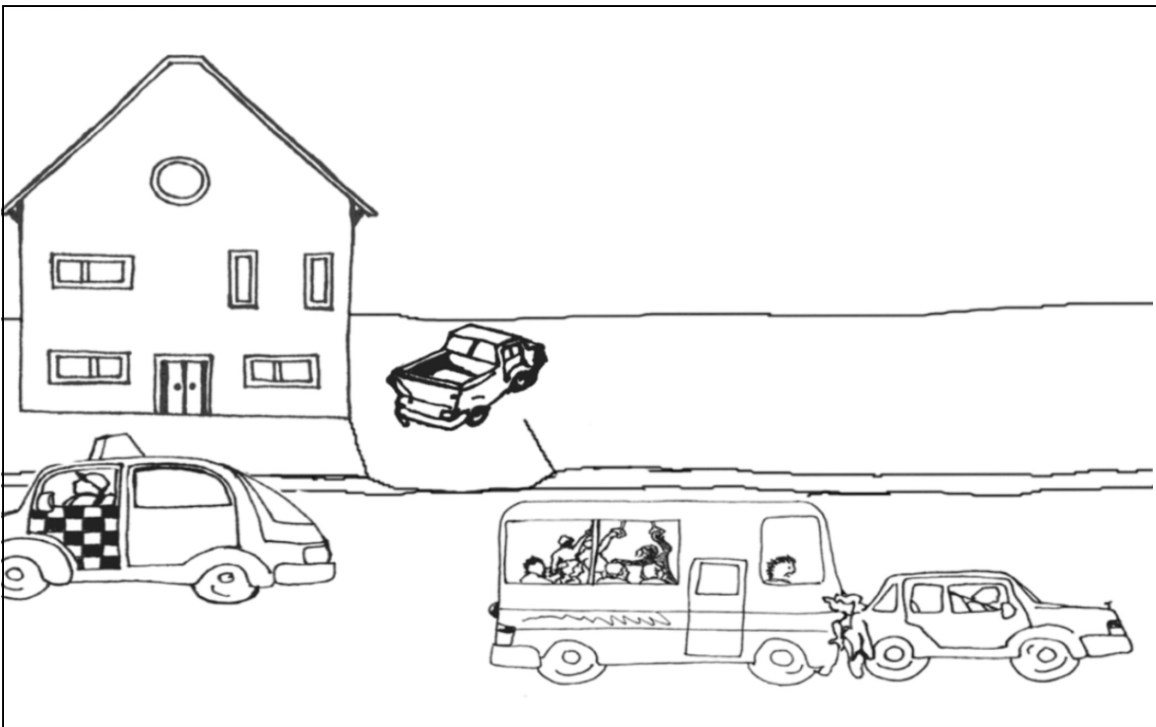
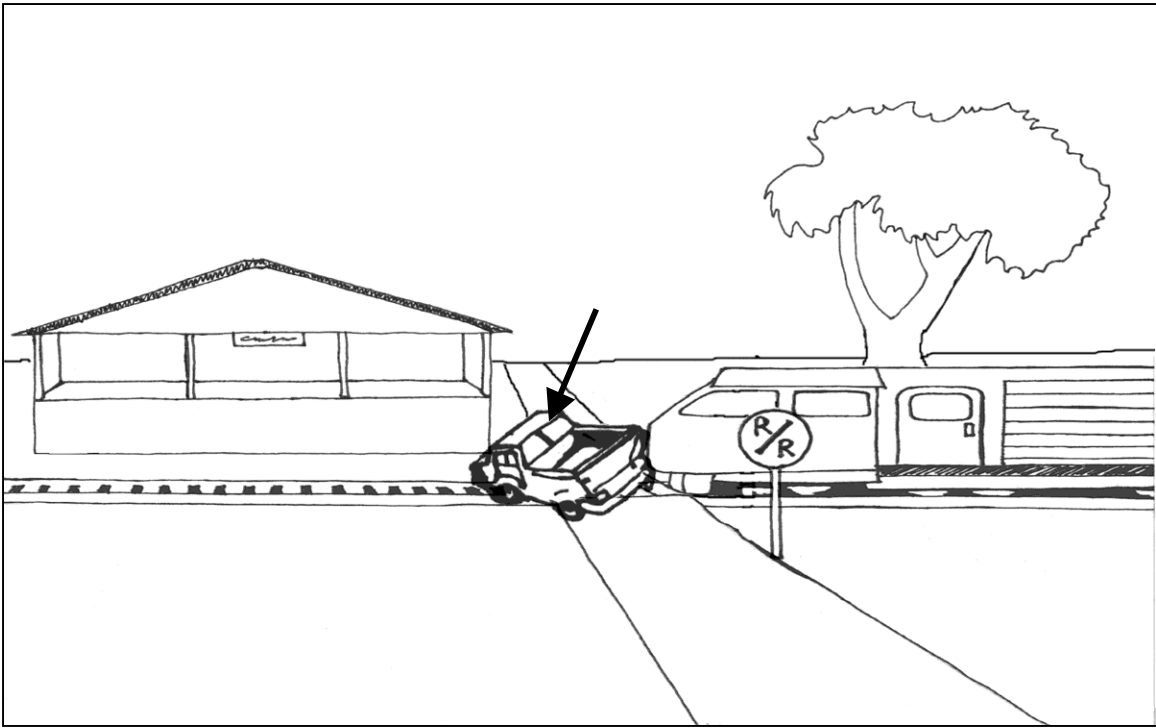

Problem 19-1a

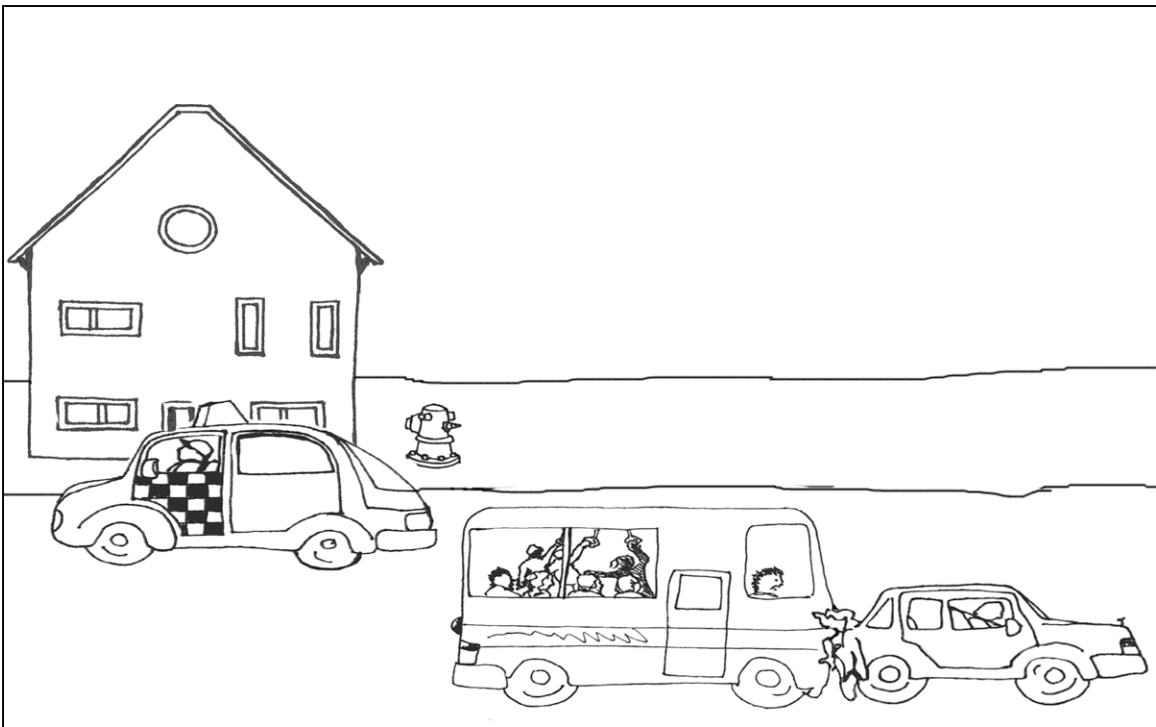
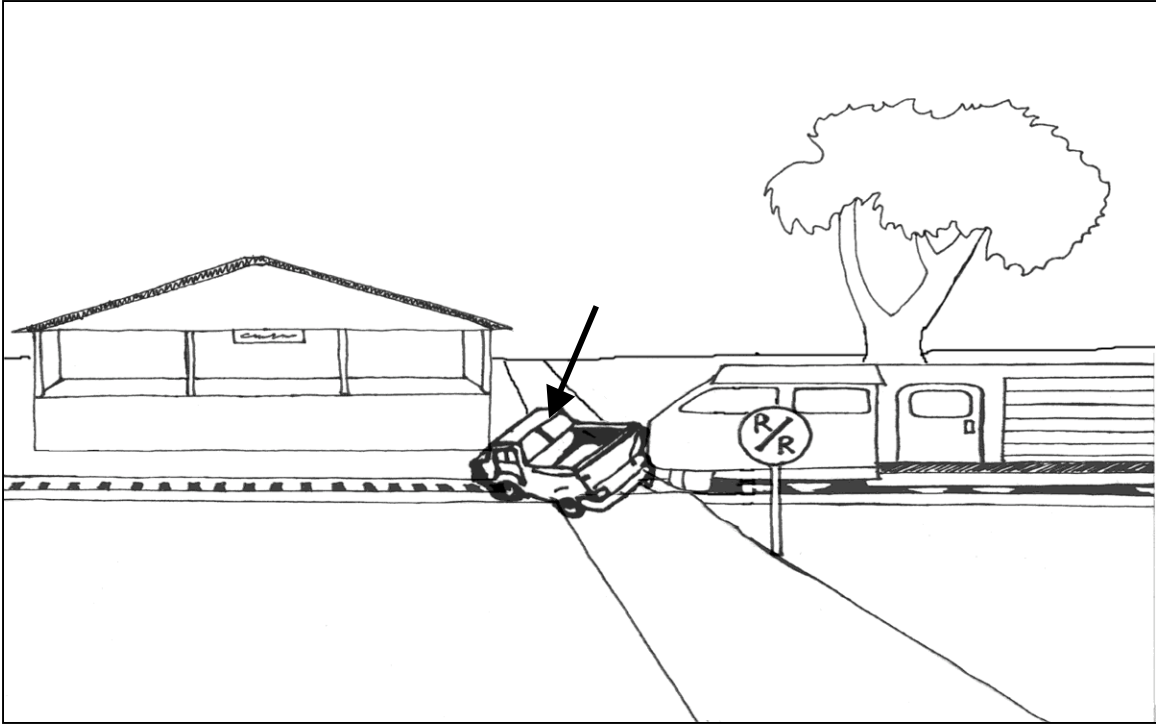

Problem 19-1b

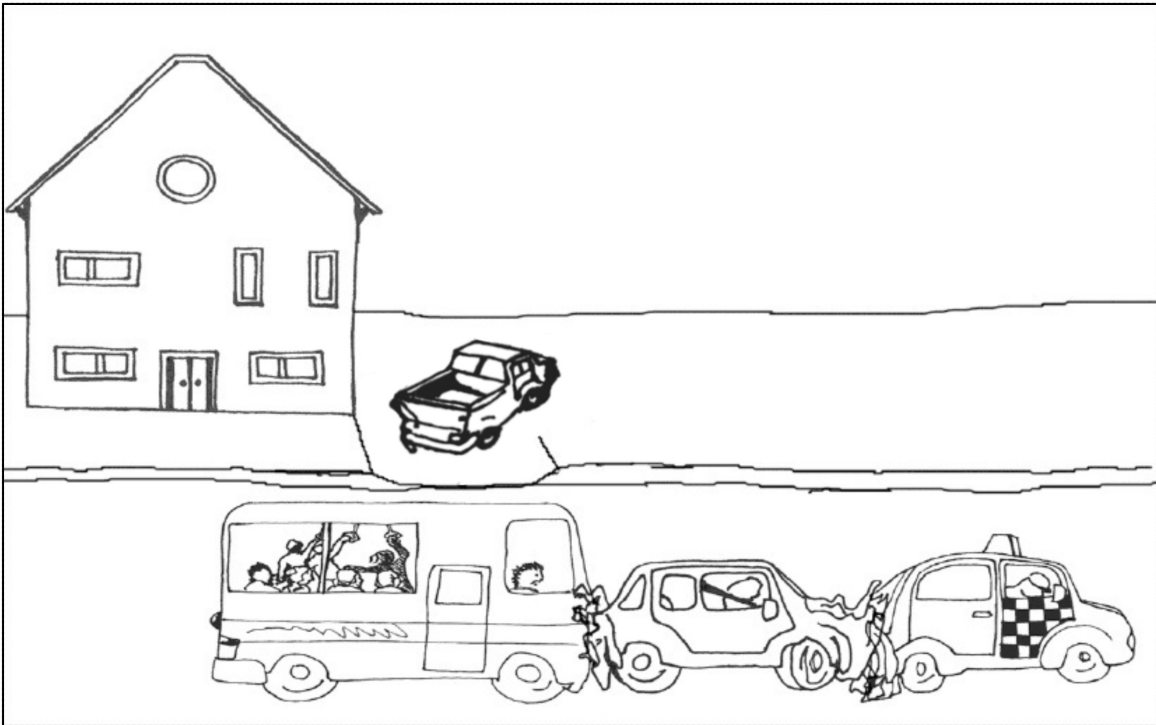
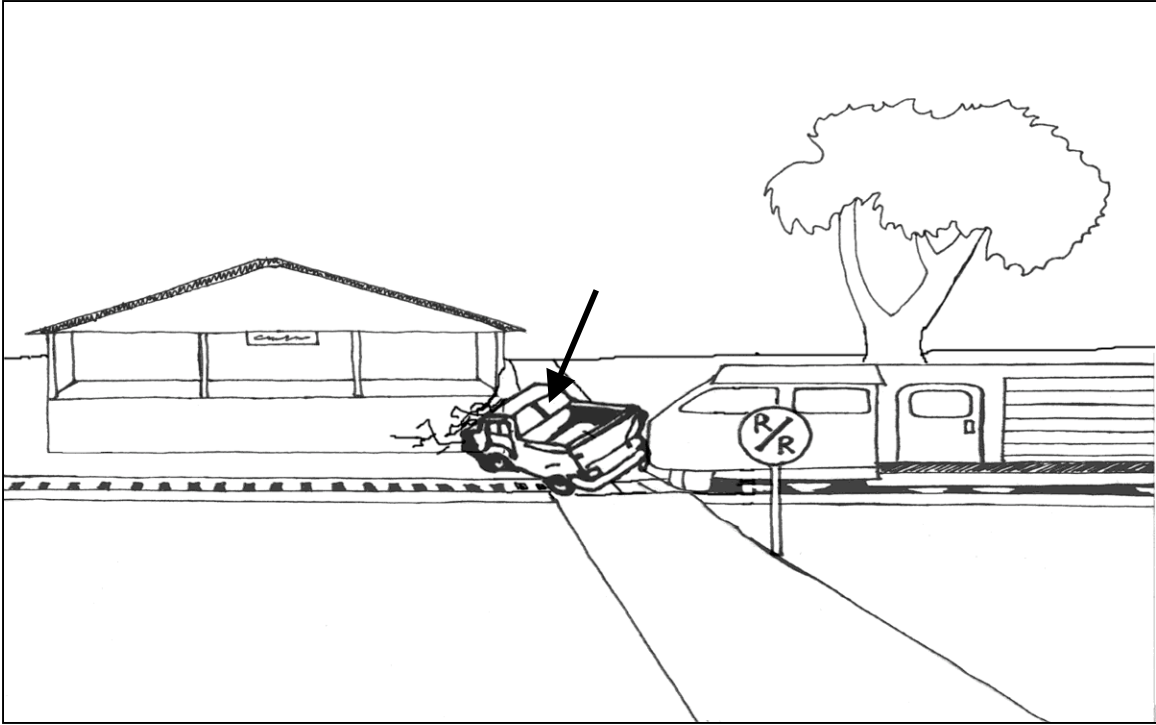

Problem 19-2a

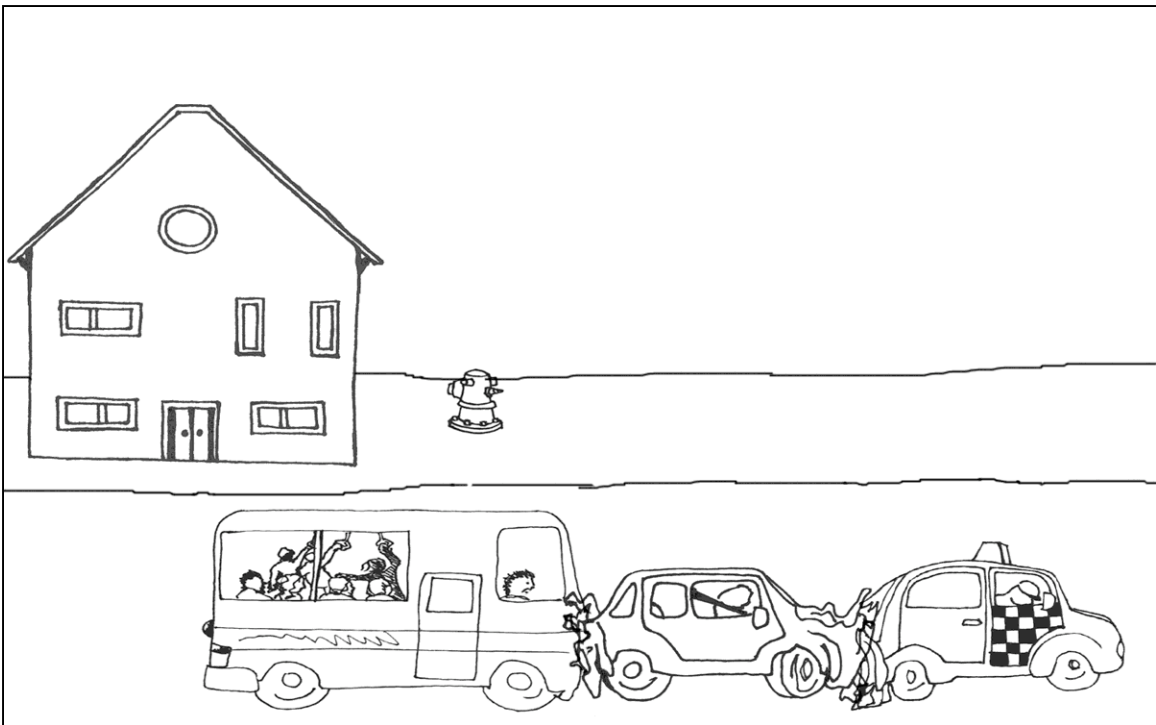
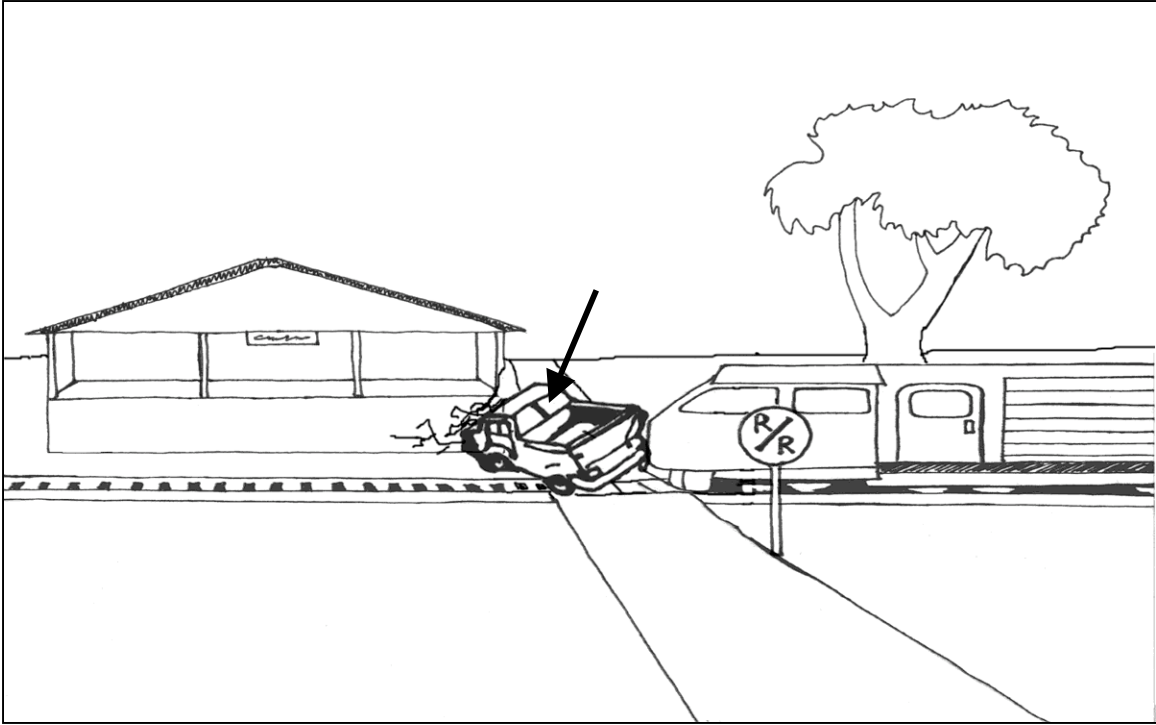

Problem 19-2b

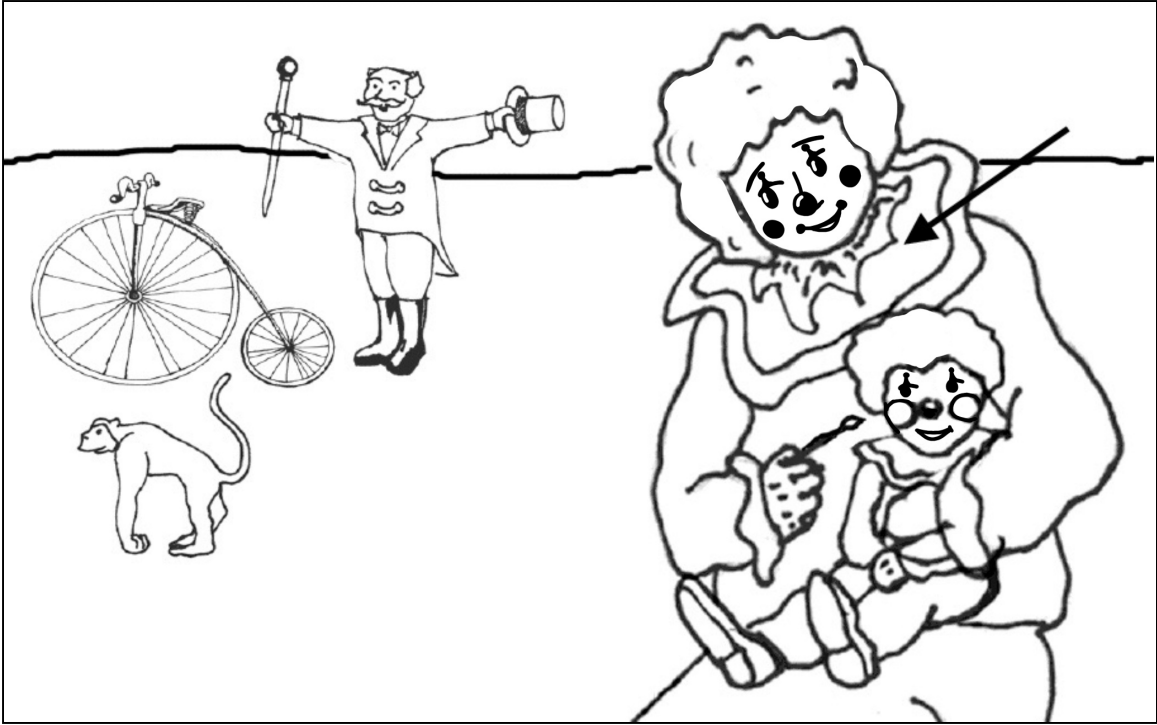

Problem 20-1a



Problem 20-1b



Problem 20-2a



Problem 20-2b